

# REVIEW AND RECOMMENDATIONS REGARDING HUMAN ACTIVITY SURVEILLANCE TECHNOLOGIES IN PACIFIC MARINE PROTECTED AREAS

Photo: Nicolas Guillemot (DEXEN)



FINAL REPORT | 2018



## DOCUMENT PRODUCTION

This study was commissioned by the French Agency for Biodiversity (AFB). It was conducted by a consortium of three expert companies – Ginger-Soproner, Bluecham and Dexen – under an AFB Procedure Contract No 2017-35.

This document has been produced with the financial assistance of the European Union. The contents of this document are the sole responsibility of AFB and can under no circumstances be regarded as reflecting the position of the European Union.

This document, its layout and the English language version are part of the Pacific Biodiversity Blue Belt project, coordinated by the Secretariat of the Pacific Regional Environment Programme (SPREP) in partnership with the French Agency for Biodiversity.

Antoine GILBERT

Director, Fisheries and Marine Sciences Department  
GINGER SOPRONER | BP 3583 | 98846 Noumea | New Caledonia  
antoine.gilbert@soproner.nc | www.soproner.nc



Rémi ANDREOLI

Director Spatial Applications  
BLUECHAM SAS | BP A5 | 98848 Noumea | New Caledonia  
remi.andreoli@bluecham.com | www.bluecham.net



Nicolas GUILLEMOT

Expert in Marine Sciences and Fisheries | Managing Director  
DEXEN | BP 32401 | 98897 Noumea | New Caledonia  
nicolas.guillemot@dexen-nc.com | www.dexen-nc.com



### ACKNOWLEDGEMENTS:

The authors would like to acknowledge all public and private sector individuals who responded positively to their requests to help conduct this study, and who shared the information at their disposal when it was liable to inform the summaries and discussions presented in this document.

**QUOTATION:** Gilbert A, Guillemot N, Andreoli R (2018) Review and recommendations regarding human activity surveillance technologies in Pacific marine protected areas. AFB and Pacific Biodiversity Blue Belt Project, 140p.

**GRAPHIC CONCEPTION AND LAYOUT EDITING:** Christine Bourgois, Cédille

**TRANSLATION:** Patrick Delhaye, Calliope Interpreters



## SUMMARY

The present study, commissioned by the French Agency for Biodiversity (Agence française pour la biodiversité, AFB), is part of the "Pacific Biodiversity Blue Belt" project. It covers four Pacific island Overseas Countries and Territories (OCTs): French Polynesia (PF), New Caledonia (NC), Wallis & Futuna (WF) and Pitcairn (Pi).

These French (PF, NC and WF) and British (Pi) territories are characterised by vast maritime areas and geographical isolation from their home States. These areas are subject to numerous and very heterogeneous uses and activities (maritime traffic, oceanic fisheries, reef fisheries, recreational activities, tourism, etc.), and are associated with major socio-economic and sustainable development issues.

The resources available to the OCTs to monitor human activities in their maritime zones, and in particular in their Marine Protected Areas (MPAs), are often very limited with regard to their size and fragmentation, and hence the need to identify innovative surveillance technologies. However, most managers in charge of large maritime areas still lack knowledge of the technologies that could be adapted to specific local and regional contexts. The content of this study thus seeks, insofar as possible, to respond to this need for information by proposing, on the basis of a document in 3 parts:

- a **general overview of maritime contexts and activities (Part 1)**, current monitoring systems, and regional influence of the four OCTs considered in the study, highlighting the main surveillance issues
- a **complete review of technologies that are adapted to the surveillance of human activities at sea (Part 2)**, assessed using objective criteria and summarised in technology sheets
- an **electronic tool to help select technological solutions (Part 3)**, based on a multi-criteria approach that aims to answer the questions of the managers who are likely to use these technologies
- an **analysis of different case studies (Part 3) to illustrate possible monitoring needs** and compare them with the available technological solutions through the use of the proposed electronic tool.

### ■ PART 1

This part required extensive information gathering. It was carried out through consultations with the managers of the maritime areas of the four OCTs (electronic questionnaire), interviews with local and regional surveillance stakeholders and the main regional organisations and, more generally, approaches to any stakeholder likely to have relevant information regarding maritime surveillance.

As previously mentioned, like many countries and territories in the Pacific region, the four OCTs are characterised by vast maritime areas, exceptional marine biodiversity, numerous marine protected areas (at multiple spatial scales), and the recent creation of very large MPAs (representing a total of over 7 million km<sup>2</sup>, among which 5 million km<sup>2</sup> are in the process of being created). These OCTs are also characterised by contrasting population levels and highly diversified maritime uses and activities.

The use of surveillance technologies appears to be widespread throughout these OCTs (this surveillance being an official mission of their home State in compliance with their obligations as coastal and maritime States), particularly in the field of controlling illegal activities (drug trafficking, illicit fishing, etc.). The solutions presently used are a combination of positioning technology (VMS, AIS, LRIT) and satellite imagery data (optical and/or radar). This kind of surveillance approach is used either exclusively (Pi) or, where they exist, in addition to conventional maritime and airborne surveillance means (NC, PF, WF).

Technological monitoring devices are also routinely used in oceanic fisheries, through the regulatory and compulsory VMS system which is installed on all OCT offshore fishing vessels. Other technological solutions have very recently been deployed in the region (e.g., e-Reporting and e-Monitoring System), improving data reliability and traceability, illegal fishing control, and thus contributing to the sustainable development of oceanic fishery activities.

The use of technology for monitoring other categories of activities such as coastal and reef fisheries, or tourism and recreational activities, remains underdeveloped, although some technologies may provide interesting solutions.

Regarding coastal and reef fisheries, the monitoring of activities is still mostly based on declarative systems and the deployment of dedicated technologies is currently anecdotal.

As for recreational activities and tourism, their very diverse and diffuse nature as well as the large number and/or small size of objects to be monitored underline the complexity of their surveillance. The latter would appear increasingly important because the level of pressure from local populations and tourists is high and increasing rapidly. The high diversity of human activities in coastal areas generates complex interactions that can lead to conflicts and environmental disturbances, raising major issues regarding their surveillance.

## ■ PART 2

This section provides a detailed review of all current or developing technological solutions for maritime surveillance. This didactic review is presented in an original way by addressing the fundamental architecture of the systems (measurement device, data transmission, ground segment), in order to document and give a better understanding of the capabilities and limitations of each type of technology. This review also addresses measurement characteristics through the notions of precision (thematic or spatial), temporality, and geographical footprint. It also details existing and emerging technologies by broad surveillance theme: vessel positioning (VMS, LRIT, AIS), imaging systems (photos/videos, geographical imagery), physical measurement sensors (radar, acoustic), or participatory systems.

## ■ PART 3

The intersection of the contexts and issues with the technological review made it possible to produce a dedicated tool in the form of an interactive catalogue that can be implemented autonomously by managers. This tool, in MS Excel© format, allows optimal technological solutions to be objectively identified through the selection of a certain number of monitoring criteria.

In the French version of the document, in order to facilitate the use of the selection tool, several case studies were chosen to illustrate some of the primary surveillance issues in the four OCTs considered. These examples highlight how the formulation of operational objectives can lead to the identification of required measures and observations, and thus to the corresponding technological solutions. Greater focus has been given to two examples to illustrate the detailed process of identifying technologies: monitoring human presence in coastal maritime areas, and monitoring whale watching activities.

By combining the tool and the case studies, the authors have been able to propose an integrated, objective and didactic vision designed to establish a decision-making aid for managers.

By way of summary, it appears that the existence, development and emergence of a large number of surveillance technologies potentially offer many answers to the challenges posed by the monitoring and surveillance of human activities at sea in the four OCTs considered in this study. While the technical questions, economic feasibility and search for optimal solutions must be conducted on a case-by-case basis, it is expected that the role of technologies in maritime surveillance will develop rapidly and contribute to enlightened spatial management, especially in MPAs.

It should also be noted that while technological solutions may improve the surveillance of maritime activities, they should not necessarily obscure monitoring arrangements that are already active and based on more conventional methods. When considering coastal fishing activities for example, the human dimension involved in the management and monitoring of activities remains crucial, and in such cases surveillance technologies would tend rather to play a secondary backup role. This could also be the case for certain recreational and tourist activities in coastal areas, for which existing surveillance systems also represent vectors of awareness and education (e.g., ranger patrols), and thus need to be encouraged although they do not directly use advanced surveillance technologies. For other activities (e.g., commercial navigation), surveillance technologies will be more likely to constitute the major part of the devices, with regard to demanding constraints of reactivity or spatial coverage. In this respect, this study has been calibrated to provide managers with the objective elements that are necessary for selecting surveillance technologies, but this selection process will eventually have to be viewed in the light of their own criteria and constraints, which can vary greatly from one territory to another.

# CONTENTS

■ <b>SUMMARY</b>	5	III. <b>SHIP POSITION TRACKING/MONITORING TECHNOLOGIES</b>	85
■ <b>FOREWORD</b>	15	III.1. General principle	85
I. <b>STUDY CONTEXT</b>	16	III.2. VMS systems	86
II. <b>OBJECTIVES</b>	17	III.3. LRIT	88
■ <b>PART 1 - CONTEXT, CURRENT MONITORING RESOURCES AND ISSUES</b>	19	III.4. AIS	89
I. <b>APPROACH: CONSULTATIONS WITH MARITIME MONITORING MANAGERS AND STAKEHOLDERS</b>	20	IV. <b>IMAGING SYSTEMS</b>	91
I.1. Consultations with managers	20	IV.1. Images and videos for visual interpretation	91
I.2. Contact with additional stakeholders and documentary searches	21	IV.2. Geographic imaging	94
II. <b>MARITIME AREAS TO BE MONITORED</b>	22	V. <b>PHYSICAL PARAMETER MEASUREMENT SENSORS</b>	111
II.1. A vast maritime and coastal area	22	V.1. Sensors and types of measurements	111
II.2. An ocean of biodiversity	26	V.2. Vectors used	114
II.3. Protected marine areas	29	V.3. Data transmission	117
III. <b>HUMAN ACTIVITIES AND THE CURRENT MONITORING SYSTEMS</b>	42	V.4. Processing and ground segments	117
III.1. Population security, geo-strategy, illegal activities, sea rescue	42	VI. <b>PARTICIPATIVE SYSTEMS</b>	118
III.2. Fishing activities in Pacific island countries and territories	51	VI.1. e-Reporting	118
III.3. Marine transport	62	VI.2. Public teleservice	119
III.4. Tourism and recreational nautical activities	66	VI.3. Cost of developing and maintaining participative systems	120
IV. <b>THE MAIN MONITORING ISSUES</b>	70	VII. <b>INTEGRATED SYSTEMS</b>	121
■ <b>PART 2 - REVIEW OF MONITORING TECHNOLOGIES</b>	75	■ <b>PART 3 - DECISION-AID TOOL FOR SELECTING THE MOST APPROPRIATE TECHNOLOGIES</b>	123
I. <b>ARCHITECTURE OF MONITORING AND TRACKING TECHNOLOGIES</b>	76	I. <b>INSTRUCTIONS FOR USING THE TOOL DEVELOPED FROM THE REVIEW OF SURVEILLANCE TECHNOLOGIES*</b>	124
I.1. The measurement device	77	■ <b>REFERENCES</b>	129
I.2. Transmission mode	79	■ <b>APPENDIX</b>	135
I.3. The ground segment	80		
II. <b>FUNDAMENTAL MEASUREMENT AND OBSERVATION CHARACTERISTICS OF A TRACKING OR MONITORING PROCEDURE</b>	82		
II.1. Data precision	82		
II.2. Data temporality for tracking and monitoring operations	83		
II.3. Measurement geographic footprint and data geographic coverage	83		

\* Section II of Part 3 is only available in the French version of the document.

# LIST OF ILLUSTRATIONS

## FIGURES

Figure 1: Location of the 4 Pacific island OCTs considered in the study and visualisation of their respective EEZ.	22	Figure 27: Geographic distribution of coastal fishing licences in French Polynesia in 2016 (source: DRMM PF 2016).	58
Figure 2: International principles for determining maritime space (source: Géoconfluences 2017).	24	Figure 28: Location of areas where technological tracking actions based on e-Reporting (ER) and e-Monitoring (EM) have been implemented (source: SPC 2016).	59
Figure 3: New Caledonia's specific maritime administrative limits.	25	Figure 29: Screen capture of the Oceanic Fisheries Program's Tails app for entering fishing data in the WCPFC area (source: SPC).	60
Figure 4: Number of species, by taxonomic group, inscribed on the IUCN's red list for the 22 Pacific island countries and territories (source: after Kinch et al. 2010).	27	Figure 30: AIS tracking of marine traffic in the South Pacific (source: www.marinevesseltraffic.com).	62
Figure 5: Level of fish consumption (kg pp/year) in the Pacific islands and territories (source: Bell et al. 2009). HIES (Household Income and Expenditure Surveys) data is extracted from census data; the SES (Socio-Economic Surveys) data is extracted from socio-economic surveys.	28	Figure 31: AIS-OPT tracking in 2017 near New Caledonia (source: MRCC 2017).	63
Figure 6: Targets of the 2014–2020 framework for the conservation of nature and protected areas in the Pacific island region, as introduced by SPREP (source: after SPREP 2015).	29	Figure 32: Caledonian Sky cruise liner moored in a reserve in Indonesia (Raja Ampat, March 2017) and having impacted on more than 18,882 m <sup>2</sup> of coral reefs (source: www.blueocean.net).	64
Figure 7: Map of the region's protected marine areas (source: SPREP). Grey lines: EEZ boundaries; light blue: large protected marine areas declared by Australia, Commonwealth of North Mariana Islands, Cook Islands, Kiribati, New Caledonia, New Zealand, Palau, Pitcairn (United Kingdom) and the United States; dark blue dots: presence of protected marine areas located within the various countries and territories.	30	Figure 33: Nature of the data potentially collected and transmitted by an AIS (source: after Serry et Lévêques. 2015).	65
Figure 8: Map extracted from the draft Decision of the Government of New Caledonia for classifying the reef-lagoon areas of the Natural Marine Park of Coral Sea as integral or natural reserves.	33	Figure 34: Breakdown of tourist arrivals by air in 2016 between 17 Pacific Island countries and territories (source: after South Pacific Tourism Organisation).	66
Figure 9: Type and number of marine protected areas in New Caledonia (the large Natural Park of Coral Sea MPA is included here) (source: after ISEE 2016).	35	Figure 35: Cumulative number of tourists in 2016 for the 17 Pacific Island countries and territories, by transport mode used (source: after South Pacific Tourism Organisation).	67
Figure 10: Number of protected marine areas and population by province in New Caledonia (excluding UNESCO areas, natural parks and the island province).	35	Figure 36: Growth in the number of cruise tourists and liners calling in to Noumea, New Caledonia (source: after ISEE).	68
Figure 11: Type and number of marine protected areas (excluding large MPAs) in French Polynesia (source: after Brugneaux et al. 2010; AFB 2018).	40	Figure 37: Change in the number of cruise tourists between 1984 and 1999 in French Polynesia (source: after Blondy 2011).	68
Figure 12: Number of reserves and population by sector in French Polynesia.	41	Figure 38: Seasonal change in the number of motorised vessels by category between 2005 and 2013 (Gonson et al. 2016). Grey: data for number of days. White: data for number of weekends.	69
Figure 13: Sea routes, identification of areas with issues for the French OCTs in the Pacific island region (source: Anon 2015).	42	Figure 39: Maritime traffic density in the South Pacific region (source: SPREP 2014).	71
Figure 14: Monitoring resources of the Armed Forces in the New Caledonia – Also, the Entrecasteaux multi-mission vessel (B2M) not shown above (source: FANC).	44	Figure 40: Illustration of the interaction between human activities coastal areas (source: Le Tixerant, 2004).	73
Figure 15: Monitoring and intervention resources of the services and departments other than those of the FANC available in New Caledonia (source: FANC).	45	Figure 41: Standard architecture for monitoring and tracking technology.	76
Figure 16: Armed Forces interception of Vietnamese blue boats illegally fishing in the New Caledonian EEZ (source: www.colsbleus.fr).	46	Figure 42: Left, a satellite (vector) with an on-board imaging radiometer (sensor) (source: after DigitalGlobe); right, high altitude drone (vector) carrying a camera (sensor) (source: Aces Flying High).	77
Figure 17: Maritime information fusion centre at the French Polynesia shared maritime centre.	48	Figure 43: Left, VHF receiving antenna for AIS signal (source: Comar SYSTEMS); right, direct receiving station for satellite images (source: Panem et al. 2012).	79
Figure 18: Boundary of the EEZ and the Pitcairn Islands Maritime Reserve (source: The Pew Charitable Trusts).	49	Figure 44: Left, ground receiving system for fisheries monitoring using a smartphone (source: Mallalieu and Andrews 2014); right, VMS control centre (source: Trackwell VMS).	81
Figure 19: Unmanned surface vehicle (USV) (Wave Glider by Liquid Robotics) uses wave and solar energy (source: Liquid Robotics).	50	Figure 45: Point data with global geographic cover; example of AIS by satellite (source: SpaceNews Magazine).	84
Figure 20: Photograph captured by the Wave Glider camera and sent by satellite (source: Liquid Robotics).	50	Figure 46: Examples of various geographic coverages of satellite images (source: BLUECHAM SAS).	84
Figure 21: Diversity of coastal (Coastal fisheries) and deep-sea (Oceanic fisheries) fishing in Pacific island countries and territories (source: after CPS).	51	Figure 47: General principle of the technologies for tracking vessel positions (source: Seawatch).	85
Figure 22: Contribution of the various types of fisheries to the total volume catch for the 22 Pacific island countries and territories (source: after Gillett 2016).	52	Figure 48: Organisation of the LRIT system (source: Pole Star).	88
Figure 23: Volume (in tonnes) of fisheries catches for the Pacific island countries and territories (source: after Gillett 2016).	53	Figure 49: Initial principle of AIS (source: United States Coast Guard Boating Safety).	89
Figure 24: Illustration of the VMS fishing vessel monitoring chain (source: www.fish.wa.gov.au).	54	Figure 50: Map showing the density of AIS and S-AIS signals in 2016 (source: OpenWeatherMap).	89
Figure 25: Volume (tonnes) and value (XPF millions) of fish catches and aquaculture production in the four European Pacific OCTs (source: Gillet 2016, value converted at the rate of USD1 = XPF100).	55	Figure 51: Top, Gardian used by New Caledonia's AEM (Action de l'Etat en Mer) (source: Marine française); bottom left, professional civilian drone; bottom right, military drone. (source: Smith 2016).	92
Figure 26: Illustration of the French Polynesia fishing port (left) and the fisheries wharf of the Autonomous Port of New Caledonia (source: Port Autonome de Papeete and DAM de Nouvelle Calédonie).	57	Figure 52: Video of a vessel taken by the camera on a Wave Glider after acoustic detection (© Liquid Robotics).	93
		Figure 53: EMS system aboard a fishing vessel (© Traceall Global).	93
		Figure 54: Left, imagery generated by an imaging radiometer; right, imagery generated by synthetic aperture radar (© ESA 2017).	94
		Figure 55: Spectral bands and resolution of the Sentinel-2 MSI sensor (after © ESA).	95
		Figure 56: Left, detection of a "mineral" object on the water's surface by high-resolution imaging radiometry; centre, recognition of a ship by high-resolution imaging radiometry (same resolution and same scale as the image on the left); right, identification of a catamaran with a composite hull by very high resolution superspectral imaging (© ESA 2017, © DigitalGlobe 2017, BLUECHAM SAS processing).	96
		Figure 57: Left, turbid plume after heavy rain in July 2013, Baie de Port Boisé (New Caledonia) (© DigitalGlobe 2013, BLUECHAM SAS processing); right, phytoplankton estimate from the MODIS radiometer (© IRD, Dupouy et al. 2014).	96

## LISTE DES ILLUSTRATIONS

Figure 58: Principles of radar sensors.	97
Figure 59: Interaction of the radar signal with the targets and its signal polarisation.	97
Figure 60: Left, an ore carrier detected by the Sentinel-1 radar at 25m (© ESA); right, a cargo vessel observed by RADARSAT-2 Ultra Fine at 3m (© MDA).	98
Figure 61: Left, detection of an oil spill from an ENVISAT (© ESA) image; right, detection of wave trains by ALOS PALSAR (© JAXA, BLUECHAM SAS processing).	99
Figure 62: Left, mid-endurance professional drone; right, long-endurance professional drone (source: Smith 2016).	100
Figure 63: Airbus Qinetiq Zephyr 7 drone (source: ARS Technica).	100
Figure 64: Programming plan for Sentinel-1 (source: ESA).	103
Figure 65: Programming plan for Sentinel-2 (source: ESA).	103
Figure 66: Landsat-8, first year of acquisition (source: Ch. Hormann, imagico.de).	104
Figure 67: Detection of boats (left) and frequency map from data from the Sentinel-2 (© ESA), constellation (Andreoli, Kinne, and Lille 2017).	104
Figure 68: Satellite data transmission modes (sources: left, European Space Agency; centre, BLUECHAM SAS; right, BLUECHAM SAS).	106
Figure 69: Example of automatic detection of boats from 30 cm data (© DigitalGlobe 2017, BLUECHAM SAS processing).	108
Figure 70: Example of a processed SkySat image (Calibration, orthorectification and signal boost © Planet Labs Inc.).	109
Figure 71: Promotion of the PAZ launch in March 2018 (© Airbus).	110
Figure 72: Left, sun-synchronous polar orbits of the Worldview satellites; right, mid-latitude orbits of the Scout and Legion constellations. (source: DigitalGlobe).	110
Figure 73: Surface radar for coastal surveillance (© Kelvin Hughes).	111
Figure 74: Principle of the HFSWR or HF radar HF (© Diginext).	112
Figure 75: Example of a Stradivarius HFSWR bistatic radar (© Diginext).	112
Figure 76: A hydrophone array (source: Marguer et al. 2013).	113
Figure 77: Network of transmitting antennas for a HFSWR (© DigiNext).	114
Figure 78: Top, eFolaga autonomous underwater vehicle (Maguer et al. 2013); bottom, Liquid Robotic's Wave Glider unmanned surface vehicle (Manley 2008).	115
Figure 79: Sensor positions on a Wave Glider (source: Guyonnet 2016).	116
Figure 80: Cook Island fishers using the Tails e-Reporting app developed by CPS (© CPS "Tuna Catch Monitoring Enters the Electronic Age" 2017).	118
Figure 81: Screen shots of the CPS Tails e-Reporting app for collecting small-scale tuna fishing data for the WCPFC (© CPS).	119
Figure 82: Left, Themis app (© CLS); right Qëhnelö web app (© BLUECHAM SAS).	121

## TABLES

Table 1: Land surface area, EEZ surface area and population of the 22 Pacific island countries and Territories (source: after Gillet 2017).	23
Table 2: Distribution of management responsibility around fishing and the environment in the various maritime areas of the study OCTs.	25
Table 3: Reef surface areas of European OCTs in the Pacific region (source: after Andréfouët et al. 2008).	26
Table 4: Indicative number of Marine species identified in relatively shallow water (0-100m) (after Vendel et al. 2016; Churyard et al. 2016; Irving & Dawson. 2013). The level of completeness varies depending on the territory.	28
Table 5: Type, number and surface area of protected marine areas in Pacific Island countries and territories (source: after PIPA, april 2018).	30
Table 6: Top: characteristics of the Pacific Island OCT's large MPAs; bottom: Description of the pacific island region's large MPAs (source: after www.mpatlas.org).	32
Table 7: List of marine protected areas in New Caledonia (source: after ISEE 2016).	36
Table 8: List of marine protected areas in French Polynesia (source: after Brugneaux et al., 2010 – AFB 2017).	38
Table 9: AEM's monitoring resources in French Polynesia.	48
Table 10: Volume (in tonnes) of fisheries production and aquaculture production for the four European Pacific OCTs (source: after Gillett 2016).	55
Table 11: Detail of international traffic in 2017 for New Caledonia (source: after PANC & MRCC 2017).	63
Table 12: Indicative summary of the issues around monitoring and/or tracking human activities in the OCTs' maritime areas within the regional context.	70
Table 13: Families of sensors and sensors used for maritime monitoring and tracking.	77
Table 14: Technical parameters defining sensors.	78
Table 15: Technical parameters characterising transmission modes.	80
Table 16: Characteristic ground segment technical parameters.	81
Table 17: Relation between resolution and image coverage.	96
Table 18: Relation between resolution and image coverage for the RADARSAT sensor.	98
Table 19: Main systematic acquisition satellites or constellations for monitoring human activity at sea.	102
Table 20: Main satellites on tasking or constellations useable to monitor human activities at sea.	105
Table 21: Public prices for the main satellites on tasking and constellations suitable for monitoring human activities at sea.	105
Table 22: Main parameters and practicalities concerning managers' needs around identifying technological solutions.	125
Table 23: Secondary parameters and practicalities for refining managers' identification of technological solutions.	126



# FOREWORD



## I STUDY CONTEXT

This study, commissioned by the French Agency for Biodiversity (Agence française pour la biodiversité, AFB), was conducted as part of the BEST 2.0 Pacific Biodiversity Blue Belt project. The region covered by this project includes the following four European Overseas Countries and Territories: French Polynesia, New Caledonia, Pitcairn, and Wallis & Futuna.

Pacific islands are mostly small territories with Exclusive Economic Zones (EEZ) covering vast marine areas, and often including numerous islands, islets and reefs. Additionally, these regions are home to biodiversity that is often exceptional in global terms and must, therefore, be covered by protection measures. For example, it is for this reason that the Parc Naturel de la Mer de Corail [Natural Park of the Coral Sea] was created in New Caledonia's EEZ, resulting in one of the world's most extensive marine reserves. Many overseas island territories are however confronted with a lack of resources and expertise for monitoring and managing their Marine Protected Areas (MPA, understood in this document as all marine areas managed in the broad sense of the term and potentially involving different uses). These territories need specific management tools, adapted to the context of island communities and the extent of available resources.

Implementing an MPA management strategy adapted to each of these territories implies monitoring and tracking human activities liable to potentially impact on marine ecosystems, based on a spatialised approach (especially in the case of very large MPAs). The most frequent human activities in the Pacific region MPAs, and therefore concentrating the bulk of monitoring issues, are fishing and navigation (commercial and recreational).

Monitoring programmes currently exist at the regional and local levels in the Pacific region. However, the knowledge of the monitoring technologies liable to be adapted to these local and regional contexts would appear still to be partial and fragmented among most managers in charge of marine areas. In particular, the managers themselves have pointed out that up until now there has been no summary of the technological monitoring and tracking solutions providing them with an integrated and detailed view of the alternative techniques that might be available to them. To be operational, this review of the technological solutions must be viewed against the context and management issues specific to the four overseas countries and territories discussed in the project and must provide concrete case studies to use as decision-aid tools.

## II OBJECTIVES

In accordance with the expectations expressed for this study, the present document comprises three complementary parts:

- **The first part** provides a summary of the context, monitoring policies and maritime activities at the local and regional levels for each of the four overseas countries and territories discussed in the study (French Polynesia, New Caledonia, Pitcairn and Wallis and Futuna), in which the main challenges and needs for human activity monitoring are identified.
- **The second part** is designed to provide the decision-makers and managers with a clear and comprehensive review of the technologies suitable for monitoring and tracking human activity at sea. Each of the technological solutions studied is assessed against a list of appropriate criteria summarised in a technology data sheet (these data sheets are only available in French).
- **The third part** presents a technology selection aid tool in MS Excel© format based on a multi-criteria approach. This tool, which was presented at a workshop organised by the French Agency for Biodiversity (Agence française pour la biodiversité, AFB) and SPREP (Secretariat of the Pacific Regional Environmental Program) in July 2018 in Noumea (New Caledonia), is the subject of a detailed operational description in the report. This part also examines the main local challenges and monitoring needs through several concrete case studies. These case studies are then compared against existing technological solutions in order to formulate a set of recommendations for the most appropriate monitoring solutions<sup>1</sup>.

<sup>1</sup> This last section is only available in the French version of the document



# PART 1

## CONTEXT, CURRENT MONITORING RESOURCES AND ISSUES

## I APPROACH: CONSULTATIONS WITH MARITIME MONITORING MANAGERS AND STAKEHOLDERS

In order to propose a relevant and integrated vision relevant to the monitoring issues and context, viewed against the technological review presented in part two, it became essential to collect as much information as possible from maritime monitoring stakeholders in the Pacific region.

This information was collected in consultation with the French Agency for Biodiversity (Agence française pour la biodiversité, AFB) in three simultaneous phases:

- a detailed electronic questionnaire consultation of all maritime space managers in the four overseas countries and territories (OCTs) concerned by the present study
- contact and then interviews with the managers' support services (e.g., Action de l'Etat en Mer<sup>2</sup> for the three French overseas territories), and with the main regional organisations (e.g., the Pacific Community) to obtain information about strategies deployed at the regional level
- contact and discussions by any appropriate means (telephone, email) with the other stakeholders and sources of relevant information regarding maritime monitoring in the region.

The list of entities and organisations contacted throughout these three stages is presented in Appendix 1. It has been approved jointly with SPREP and the AFB.

### I.1. CONSULTATIONS WITH MANAGERS

Contributions from the maritime space management services within the four OCTs considered in this study were collected through a specific questionnaire. This questionnaire was designed to gain a better understanding of the systems they use at present to monitor human activity in the waters under their jurisdiction (in particular in their MPAs), together with their priorities and their needs in this area given their management targets.

In particular this approach was designed to ensure the uniform collection of the information needed for the discussions required as the study progressed.

The questionnaire, sent to the managers as an online form (translated in English for Pitcairn Islands), had eight sections:

- identity, department and function of the service surveyed
- extent of the administrative competency for the maritime area
- areas of technical expertise
- current characteristics and surface area of the MPAs
- current and past monitoring and inspection resources
- priorities and challenges for monitoring the MPAs
- current and planned use of the monitoring technologies
- inter-departmental/inter-organisation or regional synergies.

<sup>2</sup> AEM: a French administrative and operational organisation tasked with guaranteeing the State's interests at sea by making the best possible use of its resources.

The questionnaire response rate was relatively satisfactory, as 53% of the services contacted responded positively (11/21). However, few of the services opted to fill out the entire questionnaire and a significant part of the feedback was either partial or extremely brief in several cases. As a consequence, it was deemed somewhat irrelevant to seek to calculate precise statistics on the basis of responses containing large gaps as they would not be representative of all managers. On the other hand, the in-depth responses given by some managers provided precious information for the discussions about monitoring issues.

More generally, one of the strongly expressed points to come out of the questionnaires was the desire to have an objective tool in the form of a technological review coupled with selection criteria that could be applied autonomously by the managers. In particular, the findings showed that this tool could help express the specific needs of each manager.

### I.2. CONTACT WITH ADDITIONAL STAKEHOLDERS AND DOCUMENTARY SEARCHES

All the contacts (excluding managers) identified jointly with AFB and SPREP were contacted separately. Those stakeholders considered as having a major role within the four OCTs or at the regional level were interviewed in one-on-one interviews. The other relevant resource stakeholders were contacted by email or telephone with a significantly positive response rate together with a very large volume of information covering numerous monitoring issues.

At the same time, and in addition to contacting monitoring stakeholders, in-depth documentary searches were conducted with a view to compiling the main relevant work regarding the issue of regional maritime monitoring and liable to complete the material already forwarded by the stakeholders contacted. This included scientific articles, study reports, publications and all other sorts of documents deemed potentially useful for the discussions.

In response to the feedback from managers preferring an objective analysis of the contexts and technologies, and the production of a multi-criteria selection tool to be used as a decision aid, the results and discussion presented in this part 1 must be understood as the result of the priorities and issues expressed directly by certain managers, as perceived in interviews with the other stakeholders in this topic (e.g., *Service de la Coopération Régionale et des Relations Extérieures de la Nouvelle-Calédonie*, the Pacific Community (SPS), Secretariat of the Pacific Regional Environment Programme, etc.), or as deduced by integrating all the available information following this data collection phase.

## II MARITIME AREAS TO BE MONITORED

### II.1. A VAST MARITIME AND COASTAL AREA

#### II.1.1. Basic geography of the OCTs of the Pacific islands in Oceania

Among the European Union's 25 Overseas Countries and Territories (OCTs), the Pacific region contains three French territories (French Polynesia, Wallis and Futuna, and New Caledonia - yellow on Figure 1) and one British territory (Pitcairn Islands - red on Figure 1).

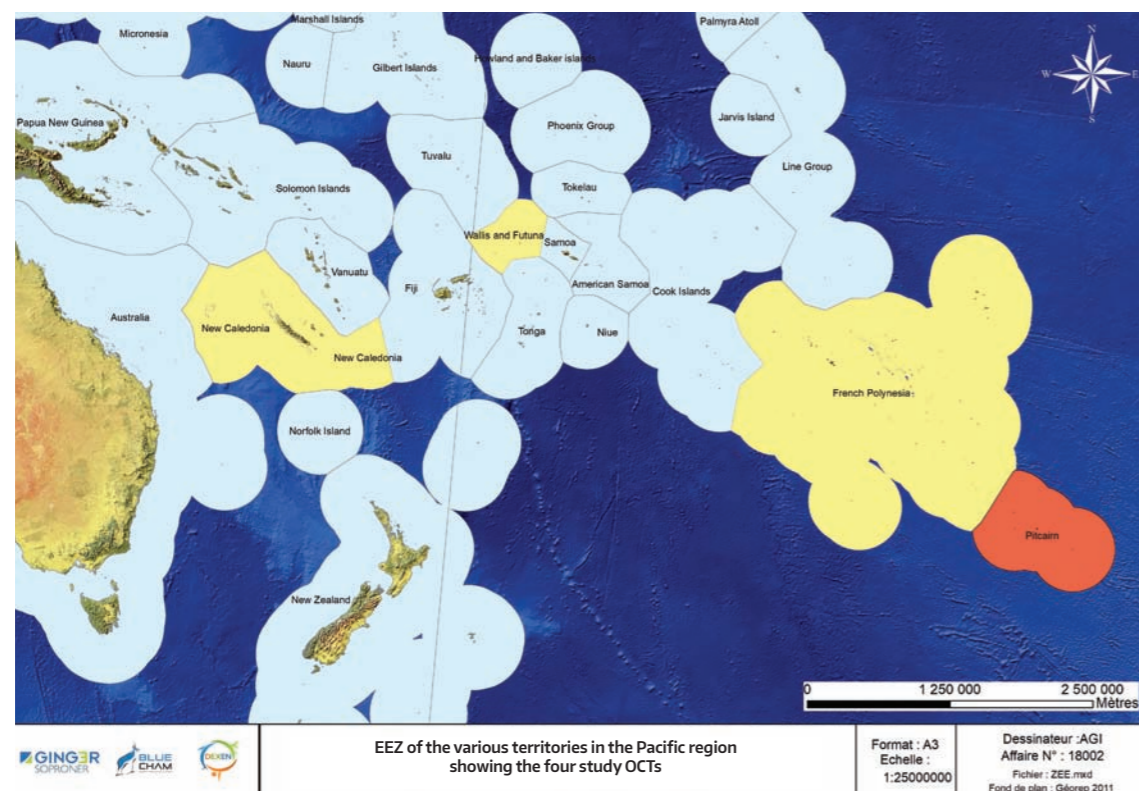

**Figure 1:** Location of the 4 Pacific island OCTs considered in the study and visualisation of their respective EEZ.

These 4 territories belong to the Pacific region called Oceania, which comprises four sub regions: Australasia, Melanesia, Polynesia and Micronesia. In all, there are 16 independent countries and 15 territories, which occupy and share this vast maritime area. These countries and territories represent a huge geographic, cultural and socio-political diversity, and have very different levels of resources. The so-called "Pacific Island" region is a sub-assembly of 14 independent countries and eight territories whose surface area and population data are provided in Table 1.

The European OCTs in Oceania have huge Exclusive Economic Zones (EEZ) and a relatively small cumulative emerged surface area (Table 1). The contributions of these OCTs' EEZs to their respective country of affiliation are significant, notably for France for which they account for more than two thirds of the national EEZ of some 11,000,000 km<sup>2</sup>.

**Table 1:** Land surface area, EEZ surface area and population of the 22 Pacific island countries and Territories

(source: after Gillet 2017).

	Country/territory	Land area (sq km)	Area of 200-mile zone (sq km)	Estimated population (July 2007)
INDEPENDENT PACIFIC ISLANDS COUNTRIES	Cook Islands	180	1 830 000	15 473
	Federated States of Micronesia	702	2 978 000	109 999
	Fiji	18 376	1 290 000	834 278
	Kiribati	726	3 550 000	93 707
	Marshall Islands	720	2 131 000	52 701
	Nauru	21	320 000	9 930
	Niue	258	390 000	1 587
	Palau	500	629 000	20 162
	Papua New Guinea	461 690	3 120 000	6 332 751
	Samoa	2 934	120 000	179 478
	Solomon Islands	29 785	1 340 000	503 918
	Tonga	696	700 000	102 264
	Tuvalu	26	900 000	9 701
	Vanuatu	12 189	680 000	227 146
PACIFIC ISLANDS TERRITORIES	American Samoa	197	390 000	65 029
	French Polynesia	3 521	5 030 000	260 072
	Guam	549	218 000	173 995
	New Caledonia	19 103	1 740 000	242 561
	Northern Marianas	475	1 823 000	64 050
	Pitcairn Islands	5	800 000	54
	Tokelau	12	290 000	1 170
	Wallis & Futuna	124	300 000	15 369

**II.1.2. Breakdown of expertise and identification of the managers concerned by monitoring and tracking human activity in the MPA (European OCTs in the Pacific)**

The EEZs (Figure 2) are a recent legal creation, determined by the third United Nations Convention on the Law of the Sea (UNCLOS), when adopting the Montego Bay agreement (10 December 1982). Control over an EEZ provides rights such as exploiting its resources, but also duties, including conservation of the environment, research operations and sea rescue.

In the OCTs, responsibility for the environment, marine resources and fisheries are managed at several levels: the State (France and the United Kingdom) exercise their authority arising under international agreements, policing fisheries and maritime surveillance. Generally, the OCT governments are responsible for regulating and exercising exploration, extraction, management and conservation of natural biological and non-biological resources throughout their entire maritime area.

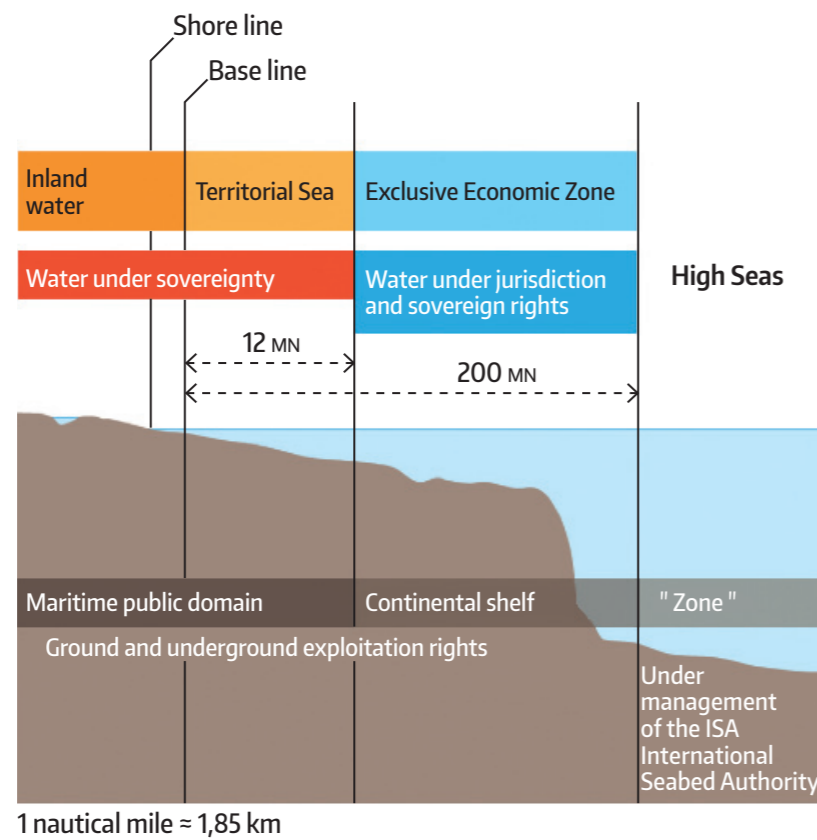

**Figure 2: International principles for determining maritime space** (source: Géoconfluences 2017).

In New Caledonia (Figure 3), responsibility for the maritime area includes an additional level of responsibility in which the Provinces (North, South and Loyalty Islands) are in charge of regulations and implementing exploration, extraction management and conservation rights for the natural biological and nonbiological resources in the provincial maritime public domain which includes the internal bodies of water and the underlying water in the territorial sea (Figure 2).

The main managers concerned by supervision and tracking human activities around fishing and the environment in the various maritime areas are listed in Table 2, as a function of the main areas of responsibility.

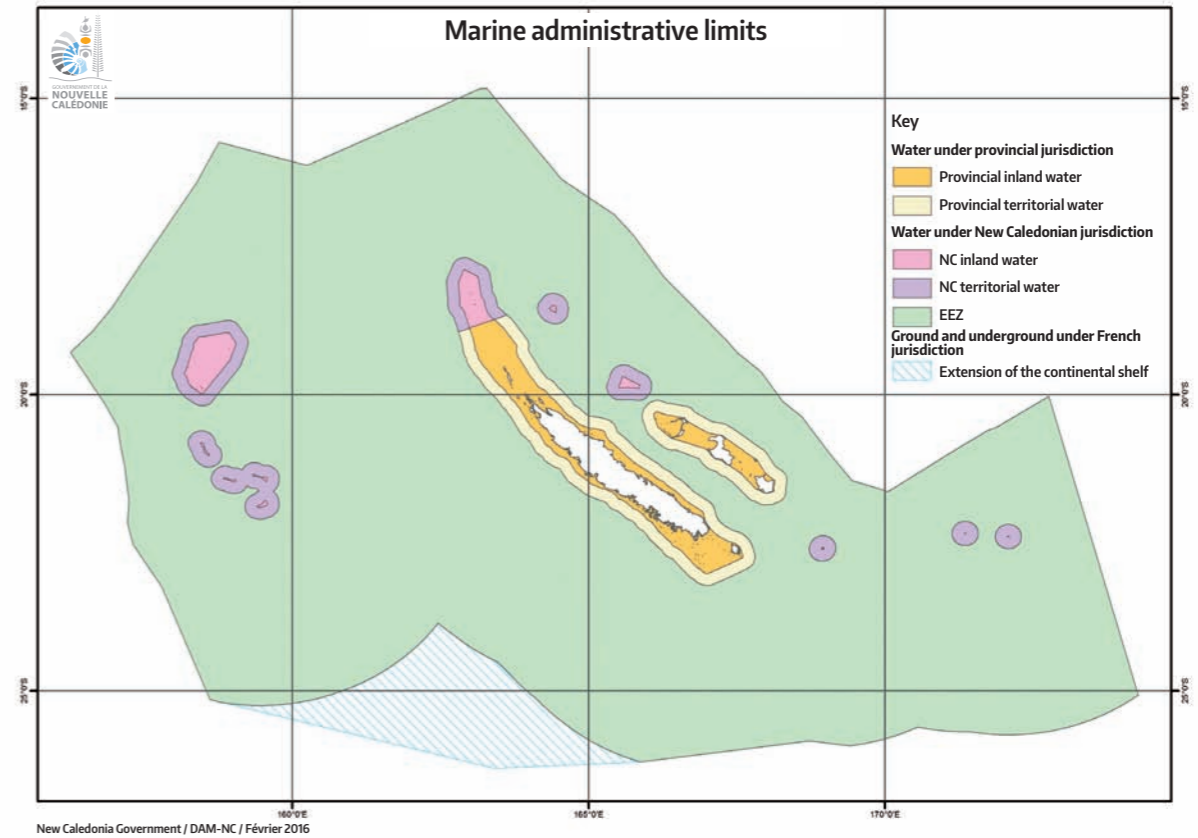

**Figure 3: New Caledonia's specific maritime administrative limits** (source: New Caledonia Government).

**Table 2: Distribution of management responsibility around fishing and the environment in the various maritime areas of the study OCTs.**

Area of responsibility	New Caledonia			French Polynesia	Wallis & Futuna	Pitcairn	
	New Caledonia Government	North Province	South Province	Loyalty Islands Province			
Fishing	EEZ	MPA			EEZ+MPA	EEZ+MPA	EEZ+MPA
Environment	Department of Maritime Affairs (DAM)	Department of Economic Development and the Environment (DDEE)	Department of Rural Development (DDR)	Department of the Integrated Economy (DEI)	Department of Marine and Mining Resources (DRMM)	Agriculture, Forestry and Fisheries Service	Government of Pitcairn Islands, Conservation & Natural Resources Division
			Department of the Environment (DENV)	Department of the Environment (DE)	Department of the Environment (DIREN)	Environment Service	

## II.2. AN OCEAN OF BIODIVERSITY

Along with its vast area, this region of the Pacific Islands has around 200 high islands and around 2,500 low islands and atolls. Basically, the size of the islands increases from east to west, with Papua New Guinea being the westernmost and with the largest land surface area (Table 1). Most of these islands emerge abruptly from the deep ocean and have a relatively limited continental shelf.

The geomorphology of coral reefs, often associated with these islands, vary significantly: fringing reefs, reticulated reefs and barrier reefs defining lagoons, atolls (remains of barrier reef islands that have subsequently subsided). However, some islands in the region, the most recent, have little or no coral formations. Similarly, mangrove ecosystems, broadly distributed throughout the region, play a strong structuring role within the coastal marine area, especially in the case of large and high islands, and provide an essential habitat for numerous marine species, especially fish.

The OCTs have remarkable reef surface areas, forming a natural heritage to be protected and managed in light of various levels of anthropomorphic pressure (from local activities to global climate change). Table 3 lists the reef surface area of each of the OCTs and their proportion relative to the emerged land.

Reflecting, among others, the omnipresence of coral ecosystems, these territories are also notable for an exceptional marine and land-based biodiversity. The number of species inscribed on the red list of the IUCN (International Union for Conservation of Nature) by major group reflects the remarkable character of this biodiversity (Figure 4).

**Table 3: Reef surface areas of European OCTs in the Pacific region** (source: after Andréfouët et al. 2008).

	Pitcairn	French Polynesia	New Caledonia	Wallis & Futuna
Reef surface area (km <sup>2</sup> )	932	3,000	4,573	425
Emerged land (km <sup>2</sup> )	47	3,660	18,575	142
Reef/Land surface area ratio	19.8	0.8	0.2	3.0

**Figure 4: Number of species, by taxonomic group, inscribed on the IUCN's red list for the 22 Pacific island countries and territories** (source: after Kinch et al. 2010).

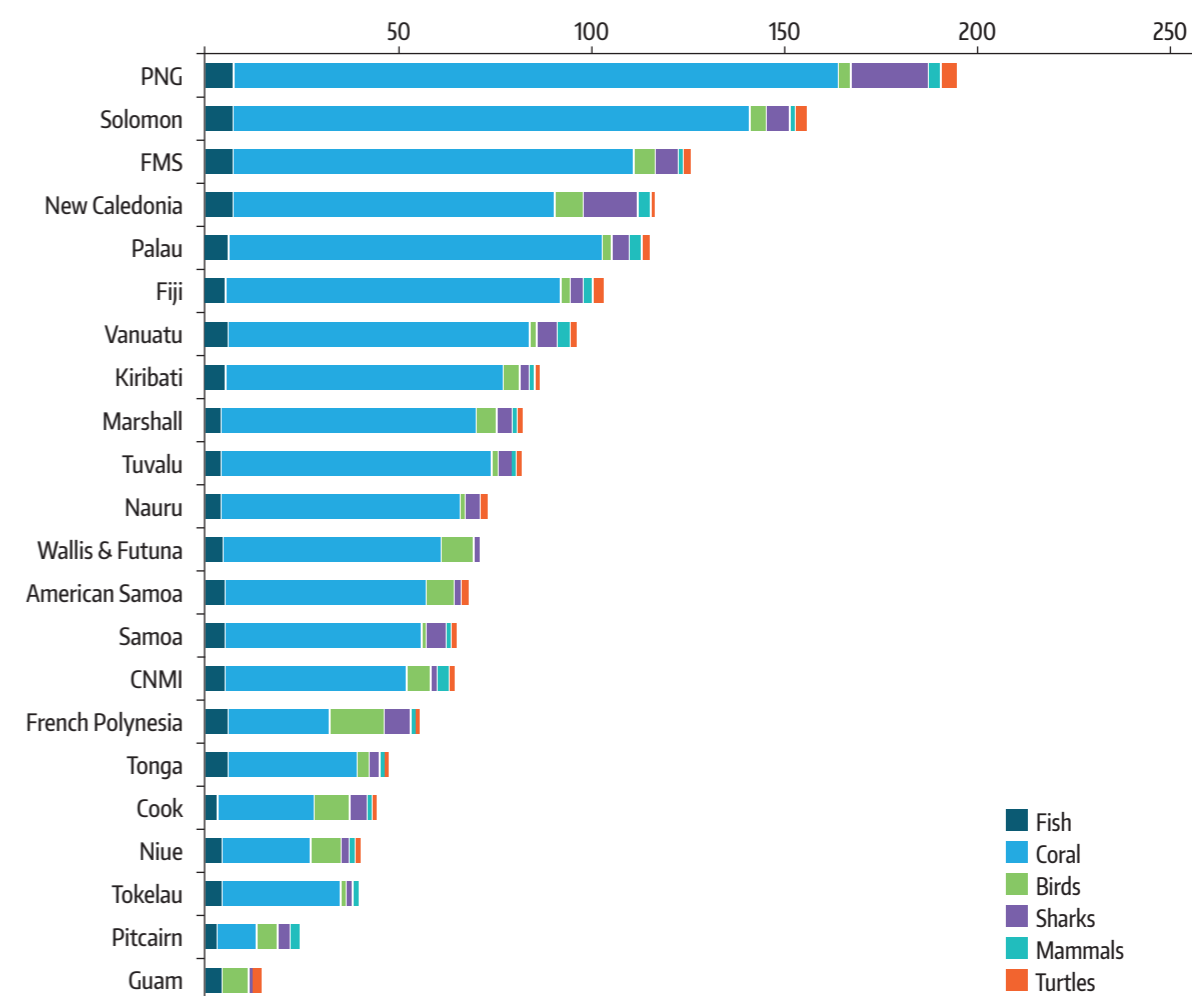

According to available data (level of completeness varies depending on the place and taxonomy, Table 5), New Caledonia has the highest level of marine organism diversity for the majority of taxonomies. French Polynesia also has a high level of diversity, well above that observed for Wallis & Futuna and Pitcairn. However, it is probable that these two territories have not historically been the subject of as thorough biodiversity inventories as New Caledonia and French Polynesia, as evidenced by the lower level of completeness for Wallis & Futuna.

For Pacific Island populations, living marine resources often occupy an essential role in their food, culture, economy and recreational activities. This high level of dependency on marine resources is clearly illustrated by the high level of fish consumption in the Pacific island and territories (Figure 5), compared with the level of consumption observed in continental countries, such as Australia (around 8 kg pp/year, FAO 1997).

**Table 4: Indicative number of Marine species identified in relatively shallow water (0-100m)** (source: after Vendel et al. 2016 ; Churyard et al. 2016 ; Irving & Dawson. 2013). **The level of completeness varies depending on the territory.**

	Wallis & Futuna	New Caledonia	French Polynesia	Pitcairn Islands
Fish	700	2 390	1 180	422
Echinoderms	29	293	308	62
Crustaceans - Decapods	137	920	741	95
Crustaceans - Other		615	257	
Molluscs	340	2 500	1 782	609
Scleratinians	183	380	213	
Algae	181	507	327	86
Sponges		160	119	15

Level of completeness: ■ > 75% ■ 50 - 75% ■ 25 - 50% ■ < 25%

**Figure 5: Level of fish consumption (kg pp/year) in the Pacific islands and territories** (source: after Bell et al. 2009). HIES (Household Income and Expenditure Surveys) data is extracted from census data; the SES (Socio-Economic Surveys) data is extracted from socio-economic surveys.

PICT	HIES			SES
	National	Urban	Rural	Coastal ± SE
<b>Melanesia</b>				
Fiji	20.7	15.0	25.3	113.0 ± 6.18
New Caledonia <sup>a</sup>	25.6	10.7	54.8	43.2 ± 3.16
Papua New Guinea	13.0	28.1	10.2	53.3 ± 2.29
Solomon Islands	33.0	45.5	31.2	118.3 ± 3.98
Vanuatu	20.3	19.3	20.6	29.9 ± 3.10
<b>Micronesia</b>				
FSM	69.3	67.3	76.8	96.0 ± 6.36
Kiribati	62.2	67.3	58.0	115.3 ± 5.32
Nauru <sup>b</sup>	55.8			62.3 ± 2.78
Palau	33.4	27.8	43.3	78.6 ± 7.91
<b>Polynesia</b>				
Cook Islands	34.9	24.8	60.9	78,5 ± 4.90
French Polynesia	70.3	52.2	90.1	60.9 ± 4.16
Niue <sup>b</sup>	79.3			49.5 ± 2.01
Samoa	87.4	45.6	98.3	94.1 ± 4.35
Tonga <sup>b</sup>	20.3			84.6 n/a
Tuvalu	110.7	68.8	147.4	145.5 ± 5.45
Wallis & Futuna <sup>b</sup>	74.6			56.2 ± 5.13

## II.3. PROTECTED MARINE AREAS

### II.3.1. Large protected marine areas of the Pacific island countries and territories

The conservation of marine resources and environments by way of protected areas in the Pacific island region is a major issue addressed by the Pacific Regional Environmental Programme (SPREP, [www.sprep.org](http://www.sprep.org)), especially within the context of actions conducted over the 2014–2020 period decided during the 9th Pacific Islands Conference on Nature Conservation and Protected Areas in December 2013. Its aims (Figure 6) are based on the fundamental roles that healthy and resilient biodiversity and ecosystems play in:

- ensuring food safety for Pacific Island populations
- supporting their sustainable development aspirations
- helping combat negative environmental effects caused by anthropomorphic activity and climate change, as well as the extreme phenomena to which the Pacific is particularly vulnerable.

SPREP also recognises the need to strengthen coordination and cooperation between the region's conservation partners and stakeholders, and to encourage synergy between the actions implemented within the many international and regional frameworks within the Pacific.

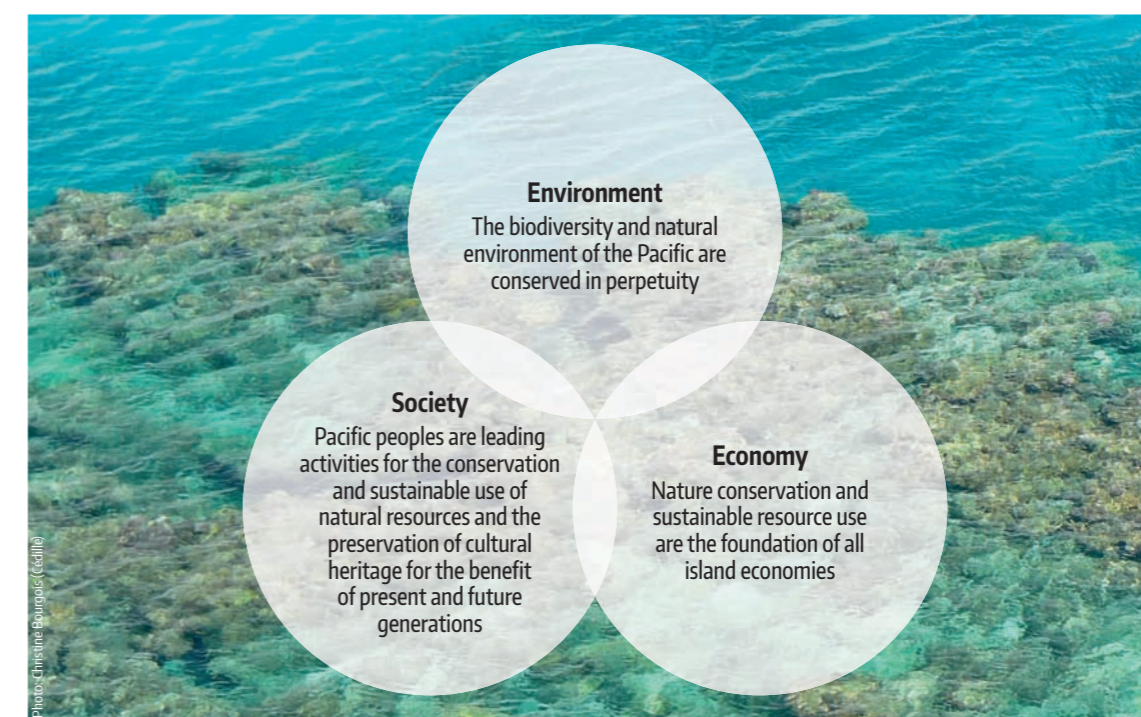

**Figure 6: Targets of the 2014–2020 framework for the conservation of nature and protected areas in the Pacific island region, as introduced by SPREP** (source: after PROE 2015).

Among the potential management measures, protected areas represent a major tool in helping protect biodiversity for the Pacific Island countries and territories. The 2020 provisions<sup>3</sup> of the working plan for the conservation of nature and protected areas in the Pacific island region include at least 17% of terrestrial and inland water and 10% of coastal and marine areas, especially areas of particular importance for biodiversity and ecosystem services, be conserved effectively and equitably managed, ecologically representative and well-connected systems of protected areas (Target 11).

<sup>3</sup> [http://www.sprep.org/attachments/Publications/BEM/Framework\\_Nature\\_Cons\\_Prot\\_Areas\\_PIR\\_2014\\_2020.pdf](http://www.sprep.org/attachments/Publications/BEM/Framework_Nature_Cons_Prot_Areas_PIR_2014_2020.pdf)

SPREP's Pacific island protected area portal (PIPAP: [www.pipap.sprep.org](http://www.pipap.sprep.org)) lists all marine and terrestrial protected areas of the SPREP member countries and territories: American Samoa, Commonwealth of the Northern Mariana Islands, Cook Islands, Federated States of Micronesia, Fiji, French Polynesia, Guam, Kiribati, Republic of the Marshall Islands, Nauru, New Caledonia, Niue, Palau, Papua-New Guinea, Samoa, Solomon Islands, Tokelau, Tonga, Tuvalu, Vanuatu, and Wallis & Futuna. SPREP also has five State members: Australia, France, New Zealand, United Kingdom and the United States of America.

Currently, there are 708 terrestrial and marine protected areas (Table 7), covering a surface area of around 2.2 million km<sup>2</sup>, identified on the PIPAP portal. In particular, 97% of the protected surface area corresponds to marine areas (Figure 7). This fact in particular should be viewed in light of the existence of very large-sized protected marine areas. Several countries and territories, such as Australia, the Commonwealth of North Mariana Islands, Cook Islands, Kiribati, New Caledonia, New Zealand, Palau, Pitcairn (United Kingdom) and the United States have designated a large part of the ocean under their jurisdiction as being protected marine areas (Figure 7).

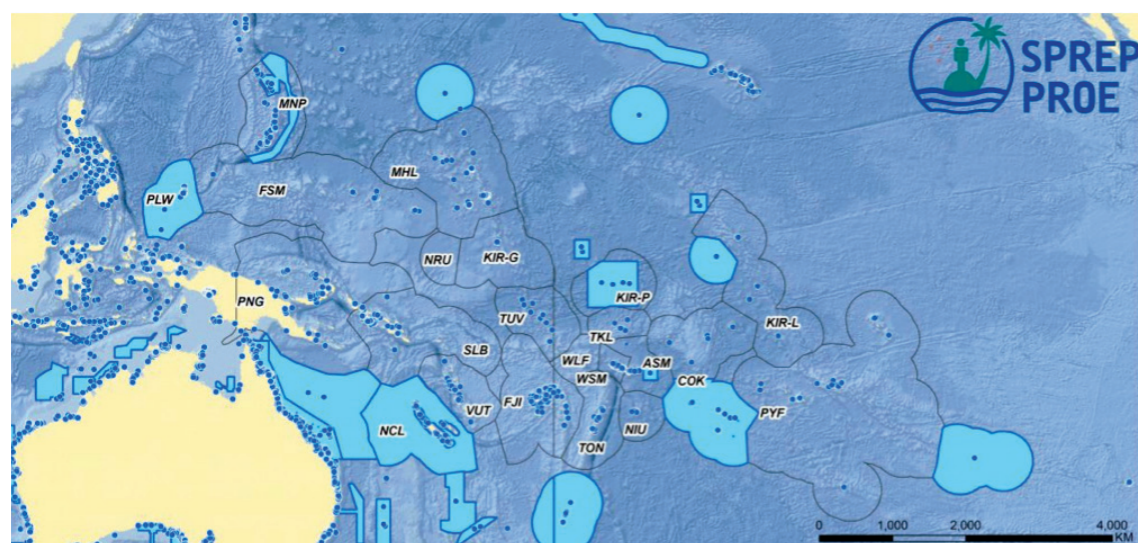

**Figure 7:** Map of the region's protected marine areas (source: SPREP). Grey lines: EEZ boundaries; light blue: large protected marine areas declared by Australia, Commonwealth of North Mariana Islands, Cook Islands, Kiribati, New Caledonia, New Zealand, Palau, Pitcairn (United Kingdom) and the United States; dark blue dots: presence of protected marine areas located within the various countries and territories.

**Table 5:** Type, number and surface area of protected marine areas in Pacific Island countries and territories (source: after PIPA, avril 2018).

	Number of reserves	Cumulative surface area (km <sup>2</sup> )
Terrestrial	158	27,337 km <sup>2</sup>
Marine & Terrestrial	204	35,774 km <sup>2</sup>
Marine	346	2,161,088 km <sup>2</sup>

With the exception of Wallis and Futuna, all Pacific island OCTs have created or planned to create large protected or managed marine areas (Table 8). These large areas, whose protected status is currently not totally finalised for the OCTs affiliated with France, are in addition to the many more conventionally sized marine areas (see chapter II.3.2). Concerning the countries targeted by the study, they are:

- in New Caledonia, in April 2014, the Government created the Natural Park of Coral Sea (PNMC), corresponding to all the marine areas placed under its responsibility, that is, the entire EEZ and remote reef areas (which, concerning the inland and territorial waters, are locked within the EEZ without being legally part thereof, cf. Figure 3). With 1,291,000 km<sup>2</sup>, it is France's largest protected marine area. Various protection and management statuses are currently being created within the PNMC, as evidenced by several draft Decisions which aim among other things to classify as natural (21,000 km<sup>2</sup>) or integral (7,000 km<sup>2</sup>, Figure 8) all the reef-lagoon areas within the Park (draft Decisions open to public consultation in June and July 2018).
- In French Polynesia, the government confirmed at the Pacific Ocean Summit in Hawaii in September 2016, then during the United Nations conference in New York in June 2017, its desire to create world's largest Managed Marine Area covering a surface area of over five million km<sup>2</sup> within the Polynesian EEZ by 2020, called Tai Nui Atea ("the vast ocean"). Changing the status of the EEZ into a managed area contributes to the change in outlook that has been ongoing for several years in the Oceania region. This strategy also seems to put on hold the large MPA projects that were underway in the Marquesas (700,000 km<sup>2</sup>) and Austral Islands (1 million km<sup>2</sup>).
- In Pitcairn, the entire EEZ has been classified as an integral reserve since with the exception of nonprofessional fishing which is authorised within the Pitcairn territorial sea (see chapter III.1.2).

The commitment of New Caledonia and French Polynesia, together with several countries in the region, to designating their waters as a sanctuary to protect sharks since 2013 and 2012 respectively (Ward-Paige 2017) is also worth noting.

Monitoring these large MPAs (i.e., > 100,000 km<sup>2</sup>) is an obvious management challenge. Maintaining regular on-site presence would seem financially prohibitive and logistically unrealistic. A collaborative approach actively involving all managers on the basis of bilateral agreements, shared feedback as well as pooling resources both for scientific research and monitoring would appear essential (Friedlander et al. 2016). This necessity has in fact led to the emergence of a network grouping the managers of 10 countries whose cumulative MPA surface area comes to around 11 million km<sup>2</sup> (<http://bigooceanmanagers.org>).

The use of emerging technologies, as detailed in the technological summary using telemetry detection, satellites and drones provides partial solutions to the monitoring challenges posed by these large reserves. As soon as the technical-economic feasibility of technological solutions has been proven, their routine use for the operational monitoring to manage MPAs will necessarily be extended and developed.



**Table 6:** Top: characteristics of the Pacific Island OCT's large MPAs; bottom: Description of the Pacific Island region's large MPAs (source: after www.mpatlas.org).

Year	OCT	Name of large MPA	Surface area (km <sup>2</sup> )	Comment	% protected	World rank
2017	French Polynesia	Te Tai Nui Atea	5,000,000	Not legally created	TBD	1/33
2016	Pitcairn	Pitcairn Islands Marine Reserve	834,334	Government Act, September 2016	100	8/33
2014	New Caledonia	Natural Park of Coral Sea	1,291,000	Government Decision March 2018	Currently being defined	4/33

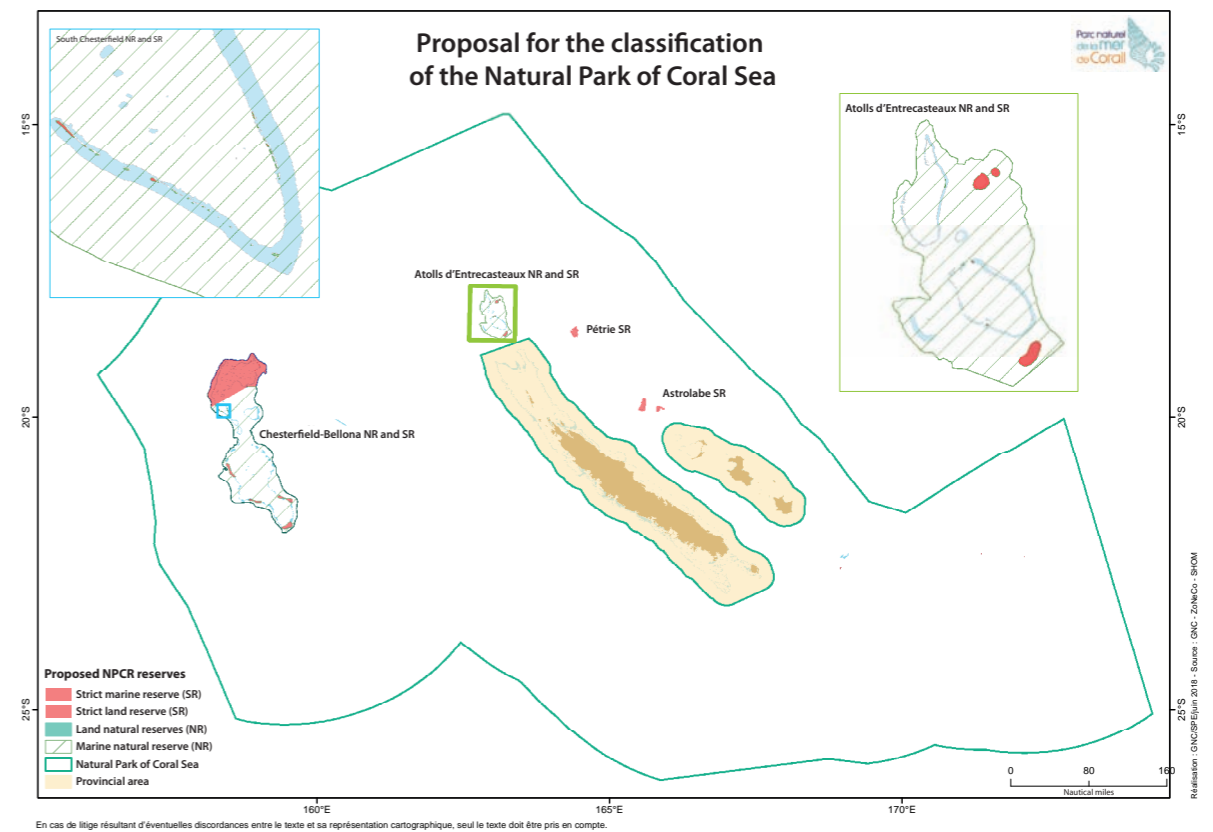
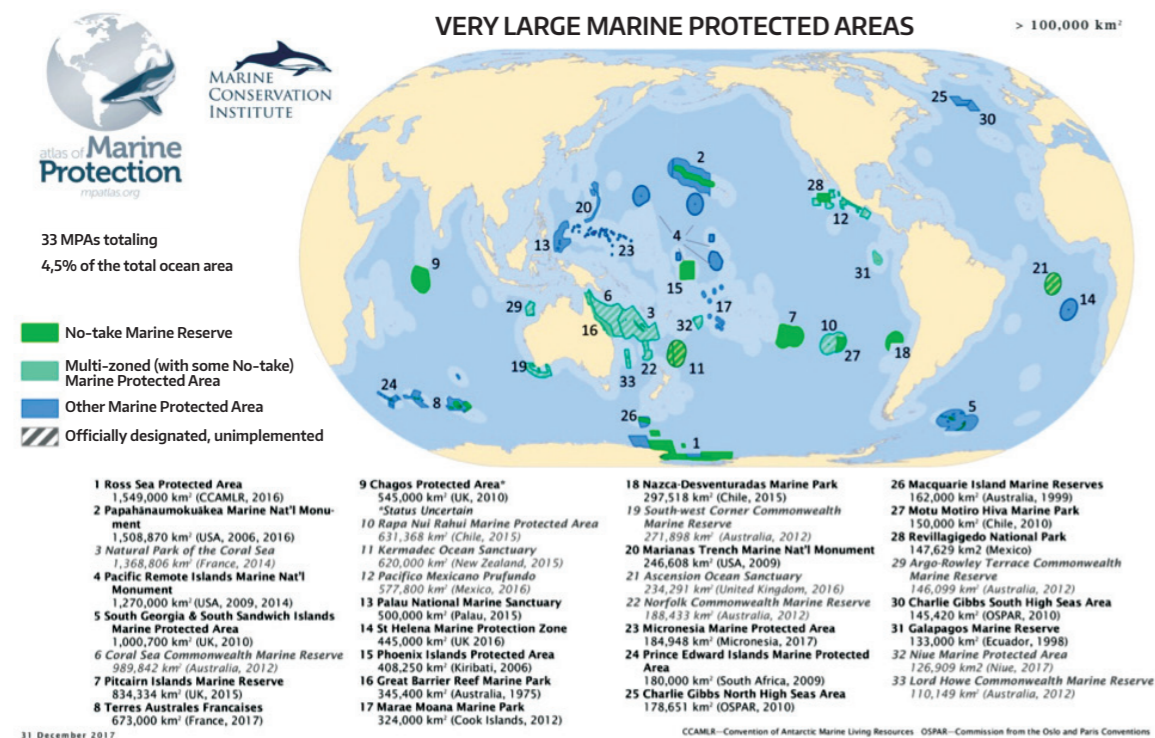

**Figure 8:** Map extracted from the draft Decision of the Government of New Caledonia for classifying the reef-lagoon areas of the Natural Marine Park of Coral Sea as integral or natural reserves. (source: New Caledonia Government).

## II.3.2. A wide range of smaller marine protected areas

### II.3.2.1. New Caledonia

#### II.3.2.1.1. Typology of the MPAs

In New Caledonia, there are five types of protected marine areas (excluding the Loyalty Islands Province covered by an "integral land reserve" status), together with an area inscribed on the UNESCO World Heritage List (Table 9 and Figure 9).

#### ■ Integral nature reserves or wilderness reserves

There are seven of these reserves which have been created to prevent any impact from human activity. Access to these reserves is strictly forbidden. The management goals for an integral reserve are, according to the terms of the South Province:

- conservation of ecosystems, biotypes and species in their natural environment
- maintaining genetic resources in a dynamic and evolving state
- maintaining established ecological processes
- protection of structural aspects of the landscape and geological or geomorphological formations
- conservation of exemplary natural environments for the purposes of study, scientific research and continuous environmental monitoring.

### ■ Natural reserves

There are 12 of these reserves which were created to enable the maintenance, conservation, and rehabilitation of threatened, endemic or emblematic species, and the restoration or reconstitution of habitats. They are accessible to the public and light infrastructure has been created for educational and awareness purposes.

### ■ Sustainable resource management areas (AGDR)

There are 10 of these areas which were created to reconcile the sustainable protection of certain ecological and biodiversity characteristics with the development of activities compatible with this aim of sustainable protection. They have a management plan setting out the protection, awareness, enhancement and sustainable development measures to be implemented within the area.

The management targets in a sustainable resource management area are the following, according to the terms of the South Province:

- ensure the long-term protection and maintenance of biodiversity and other natural, cultural or landscape values of the relevant areas
- promote sustainable management methods, especially traditional
- protect the natural resource assets against all forms of alienation caused by other forms of use of the area liable to undermine the region's biodiversity
- contribute to the local economic development and appropriate sustainable discovery and tourism activities.

### ■ The Provincial Parks

There are two of these parks which were created:

- to conserve their plant and animal species, biotopes or sites, ecosystems or processes and ecological functions
- for educational, recreational or cultural purposes.

The management aims for these parks are to maintain all the ecological functions, diversity, biological communities and to manage activities at the site in order to protect the ecological processes and interest taking into account the local population's needs.

They have a management plan setting out the protection, awareness and promotion measures to be implemented.

### ■ Les Parcs Naturels

There are two of these which were created by the New Caledonia government in order to protect the exceptional biodiversity of the New Caledonian maritime area, while still allowing responsible and sustainable economic development. This section includes the large Coral Sea MPA together with the Atolls d'Entrecasteaux Natural Park. These parks contribute to achieving target No 11 of the Strategic Plan for biological diversity signed in Aichi (Japan) in 2010, which is to protect at least 10% of the marine area 2020.

### ■ The areas inscribed on the UNESCO World Heritage List

In 2008, 1.57 million hectares of New Caledonian reefs were inscribed on the UNESCO World Heritage List. This surface area corresponds to 6 areas distributed across the entire territory. Participative management committees have been set up to preserve the integrity of this asset for the long-term. They include communities, professionals (fishers, tourism operators, farmers, etc.), associations, customary bodies and municipalities.

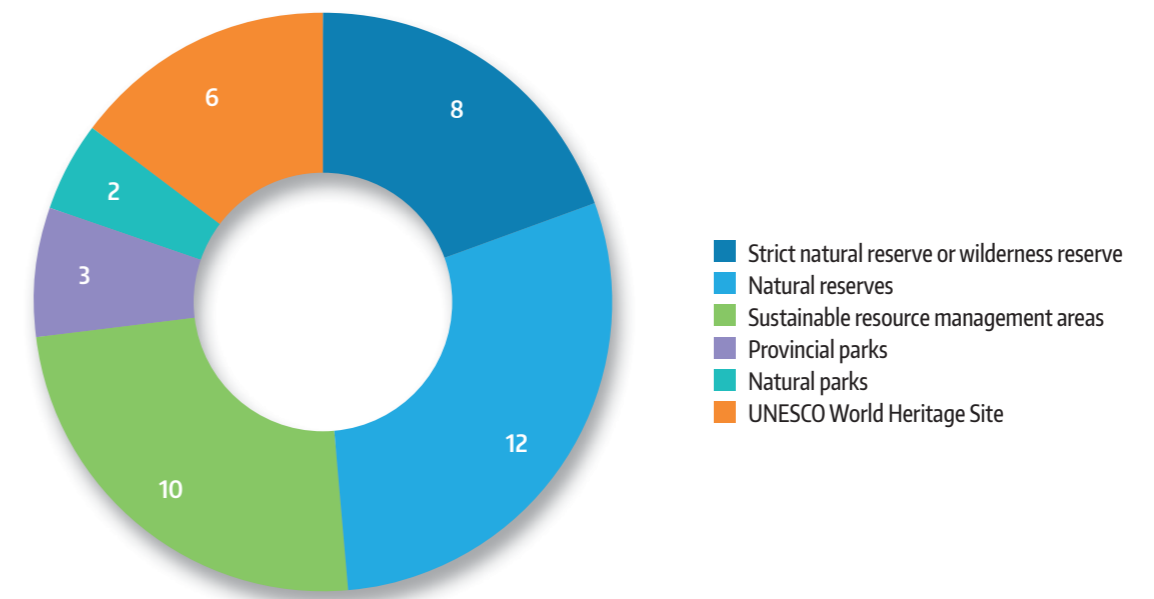

**Figure 9: Type and number of marine protected areas in New Caledonia (the large Natural Park of Coral Sea MPA is included here)** (source: after ISEE 2016).

#### II.3.2.1.2. Geographic distribution of MPAs and communities

More than three quarters of the marine protected areas (excluding natural parks, Loyalty Islands and UNESCO areas) are distributed in the South Province with almost 50% of the latter located near Noumea (Figure 10). Overall, this data is equitably linked to the level of population, three quarters of which was concentrated in the South Province in 2014 (of which 50% in Noumea).

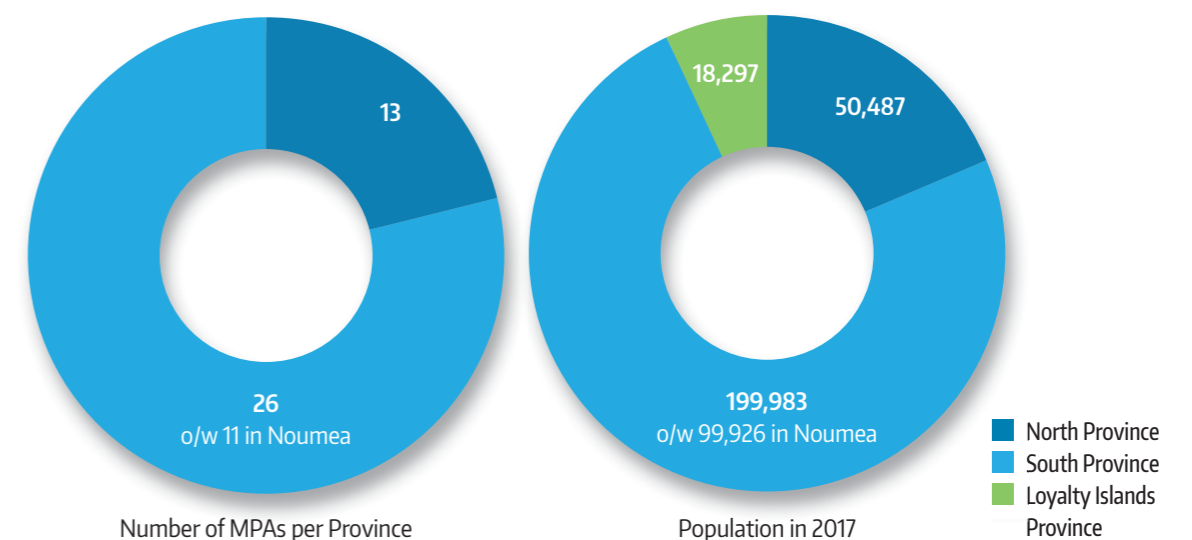

**Figure 10: Number of protected marine areas and population by province in New Caledonia (excluding UNESCO areas, natural parks and the island province)**

**Table 7: List of marine protected areas in New Caledonia** (source: after ISEE 2016).

Type of protection area	Date created	Province	Surface area (ha)
<b>Strict natural reserve or wilderness reserve</b>			<b>23 482</b>
Dohimen	2009	North	3 712
Etang de Koumac	1989	North	54
Hwanga Lédane, Péwhane et Whan-Denece-Pourape	2009	North	1 306
Ilot Goéland	1995	South	1
N'Digoro	2004	South	16
Nekoroo	2000	North	1 260
Récif Sèche-Croissant	1994	South	45
Yves Merlet	1970	South	17 089
<b>Natural reserves</b>			<b>24 487</b>
Aiguille de la Baie de Prony	1993	South	3
Epave du Humbolt	1996	South	3
Grand Port	2006	South	1 311
Grand Récif Arboré et passe de Boulari	1981	South	14 490
Île Verte	1993	South	206
Ilot Bailly	1989	South	297
Ilot Larégnère	1989	South	663
Ilot Signal	1989	South	236
Ouano	2014	South	3 498
Passe de Dumbéa	2005	South	545
Poé	1993	South	3 099
Roche percée et Baie des tortues	1993	South	136
<b>Sustainable resource management areas</b>			<b>16 333</b>
Baie de Port Bouquet	2010	South	323
Hyabé-Lé-Jao	2009	North	10 082
Ilot Amédée	1981	South	36
Ilot Canard	1989	South	149
Ilot Casy	1993	South	152
Ilot Maître	1981	South	762
Ilot Moindé-Ouémié	2010	South	52
Ilot Ténia	1998	South	1 153
Kan-Gunu	2014	North	3 579
Pointe Kuendu	1988	South	47
<b>Provincial parks</b>			<b>928 686</b>
Parc de la Zone Côtière Ouest	2009	South	255 268
Parc du Grand Lagon Sud	2009	South	672 762
Parc Provincial de Yeega	2009	North	656
<b>Natural parks</b>			<b>129 520 306</b>
Atolls d'Entrecasteaux Natural Park	2013	Government of N.C.	323 590
Natural Park of Coral Sea	2014	Government of N.C.	129 196 716
<b>UNESCO World Heritage Site</b>			<b>1 570 000</b>
Zone du Grand Lagon Sud	2008	South	
Zone Côtière Ouest	2008	South/North	
Zone d'Ouvéa/Beautemps-Beaupré	2008	Islands	
Zone Côtière Nord et Est	2008	North	
Zone du Grand Lagon Nord	2008	North	
Zone des récifs d'Entrecasteaux	2008	Government of N.C.	

## II.3.2.2. French Polynesia

### II.3.2.2.1. Type of MPAs

In all, there are around 50 protected marine areas (Table 10 and Figure 11) in French Polynesia. They are distributed between the Austral Islands, the Society Islands, Tuamotu Archipelago and Marquesas Islands. They have various levels of protection broken down into five categories of protected areas:

#### ■ Sites classified under the Environment Code (article DIII-2 of the Environment Code)

This refers to six categories of protected areas for which the general provisions are based on the classification drawn up by the IUCN in 1994:

- Type I: Strict nature reserve / Wilderness area
- Type II: National park
- Type III: Natural monument or feature
- Type IV: Habitat/Species Management Area
- Type V: Protected Landscape/Seascape
- Type VI: Protected area with sustainable use of natural resources.

The provisions and characteristics for each of these types of protected area have been established by the IUCN and can be consulted on their website<sup>4</sup>.

#### ■ Listed sites under the Infrastructure Code

This refers to the PGEM (Marine area management plan). PGEMs were introduced as early as 1992 by the government and set out the rules for occupying or using marine areas within a municipality in order to settle usage conflicts between the stakeholders.

For example, a distinction is made between the Moorea PGEM and the Fakarava municipality biosphere reserve, which is covered by a particularly detailed management plan. In Moorea, 5,000 ha has also been recognised under the Ramsar Convention on Wetlands of International Importance since 2008.

#### ■ Regulated Fisheries Areas (ZPR)

These are determined by Ministerial Decision in order to protect and preserve marine resources and aquaculture by taking measures to settle chronic disputes around their exploitation, and introducing fisheries reserves.

#### ■ Marine sanctuaries

The entire French Polynesian EEZ is a sanctuary for the protection of sharks, sea mammals and turtles. They are entirely protected throughout the EEZ's 5.5 million km<sup>2</sup>.

#### ■ Areas managed under local community initiatives

These are based on customs and are not subject to any regulations. In particular they refer to the Rahui (Austral Islands) areas, and the educational marine areas of the Marquesas Archipelago.

#### ■ Areas undergoing UNESCO World Heritage inscription

The Marquesas Archipelago is currently undergoing the process for UNESCO World Heritage inscription. The inscription application was presented on 10 April 2018 for nine sites distributed across the main Marquesas islands.

Table 8 shows the detailed list of Polynesian protected areas.

<sup>4</sup> <https://www.iucn.org/theme/protected-areas/about/protected-area-categories>

**Table 8: List of marine protected areas in French Polynesia** (source: after Brugneaux et al., 2010 – AFB 2017).

Name	Archipelago	Island	Date created	Status	IUCN	Marine surface areas (ha)
Rapa	Austral	Rapa		Local rahui		
Scilly	Society	Maupiti	1972 (lagoon) / 1977 (atoll)	Natural reserve	I	12 041
Bellinghausen	Society	Maupiti	1971 (lagoon) / 1992 (atoll)	Natural reserve	I	1403
Lagune de Faauna Rahi	Society	Huahine	1970	Resource protection area		
Motu Ahi	Society	Moorea	2004	Maritime space management plan	II et IV	99
Maatea	Society	Moorea	2004	Maritime space management plan	II et IV	171
Taotaha	Society	Moorea	2004	Maritime space management plan	II et IV	206
Tiahura	Society	Moorea	2004	Maritime space management plan	II et IV	240
Tetaiuo	Society	Moorea	2004	Maritime space management plan	II et IV	98
Pihaena	Society	Moorea	2004	Maritime space management plan	II et IV	58
Aroa	Society	Moorea	2004	Maritime space management plan	II et IV	31
Nuarei	Society	Moorea	2004	Maritime space management plan	II et IV	65
Lagon de Moorea	Society	Moorea	2008	RAMSAR site		5000
Papetoai	Society	Moorea	2004	Maritime space management plan	II et IV	
Maharepa	Society	Moorea	2004	Maritime space management plan	II et IV	
Motu Tapu	Society	Bora Bora	1963	Protected landscape	V	
Matavai	Society	Tahiti	2007	Resource protection area		140
Muriavai	Society	Tahiti	1997	Resource protection area		777
Taaone	Society	Tahiti	2003	Resource protection area		60
Moana Nainai	Society	Tahiti	2006	Resource protection area		60
Lagune	Society	Huahine	1970	Resource protection area		
Maiao	Society	Maiao		Local rahui		
Hotu Ora	Society	Tahiti	2015	Resource protection area		
Punaauia	Society	Tahiti	2016	Resource protection area		
Teva I Uta	Society	Tahiti	2015	Resource protection area		
Tetiaora	Society	Tahiti	2014	Resource protection area		
Pari	Society	Tahiti	1962 modified 2011	Protected landscape	V	
Teahupoo	Society	Tahiti	2014	Managed natural resources area	VI	768
Aratika	Tuamotu	Aratika	2007 modified 2016	Biosphere reserve	IV et IV	14 500
Fakarava	Tuamotu	Fakarava	2007 modified 2016	Biosphere reserve	III, IV, VI, V	115 300
Espace inter-communal	Tuamotu	Fakarava	2016	Biosphere reserve	IV	1 594 828
Kauehi	Tuamotu	Kauehi	2007 modified 2016	Biosphere reserve	IV et IV	31 995
Niau	Tuamotu	Niau	2007 modified 2016	Biosphere reserve	I et IV	3 300
Raraka	Tuamotu	Raraka	2007 modified 2016	Biosphere reserve	IV et IV	34 270
Taiaro	Tuamotu	Taiaro	2007	Maritime space management plan	II et IV	923
Toau	Tuamotu	Toau	2007 modified 2016	Biosphere reserve	IV et IV	56 100
Hopue	Tuamotu	Tatakoto	2004	MPA for giant clams / Resource protection area		62
Tatakoto	Tuamotu	Tatakoto	2014	Resource protection area		
Napuka	Tuamotu	Napuka		Local rahui fishing and giant clam		Entire lagoon
Arutua	Tuamotu	Arutua		Local rahui fishing		Entire lagoon
Fakahina	Tuamotu	Fakahina		Local rahui fishing		Entire lagoon
Puka Puka	Tuamotu	Puka Puka		Local rahui		
Fangatau	Tuamotu	Fangatau		Local rahui giant clam / municipal fishing order		Entire lagoon
Te Roto Uri Fa'ahotu	Tuamotu	Rangiroa	2015	Resource protection area		
Reao	Tuamotu	Reao	2016	Resource protection area		5200
Taiaro	Tuamotu	Fakarava	1972/1977 modified 2007/2016	Biosphere reserve	VI et I	
Eiao	Marquises	Nuku Hiva	1971 modified 2011	Habitat or species management area	IV	
Hatutaa	Marquises	Nuku Hiva	1971 modified 2011	Habitat or species management area	IV	
Motu one	Marquises	Nuku Hiva	1971 modified 2011	Habitat or species management area	IV	1
Mohotani	Marquises	Hiva Oa	1971 modified 2011	Habitat or species management area	IV	194
Hohoi	Marquises	Ua Pou	1952 modified 2011	Protected landscape	V	
Baie des vierges	Marquises	Fatu Hiva	1952 modified 2011	Protected landscape	V	

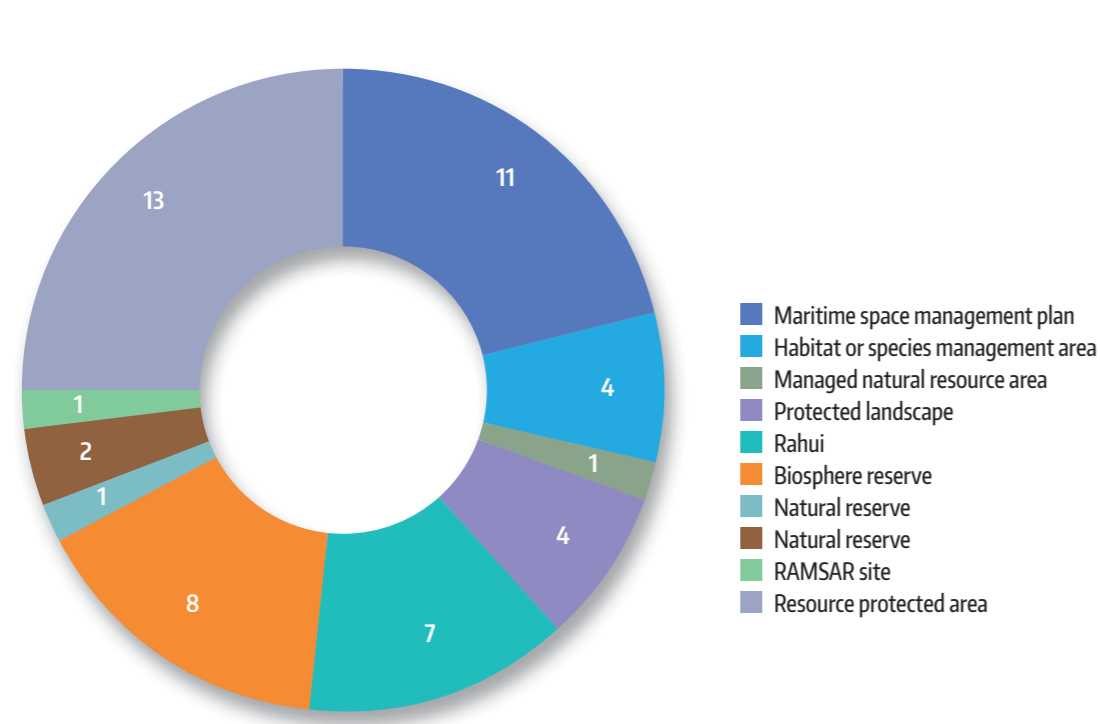

**Figure 11:** Type and number of marine protected areas (excluding large MPAs) in French Polynesia (source: after Brugneaux et al. 2010 ; AFB 2018).

#### II.3.2.2.2. Geographic distribution of MPAs and population

More than three quarters of the marine protected areas in French Polynesia are concentrated in equal proportion in the Windward Islands and the Tuamotu Archipelago (Figure 12). The Austral Islands, Marquesas Islands and Leeward Islands have respectively one, six and five marine protected areas. In comparison, three quarters of the Polynesian population is concentrated in the Windward Islands and Austral Islands; the remaining quarter is dispersed across the other islands with a dominance in the Leeward Islands.

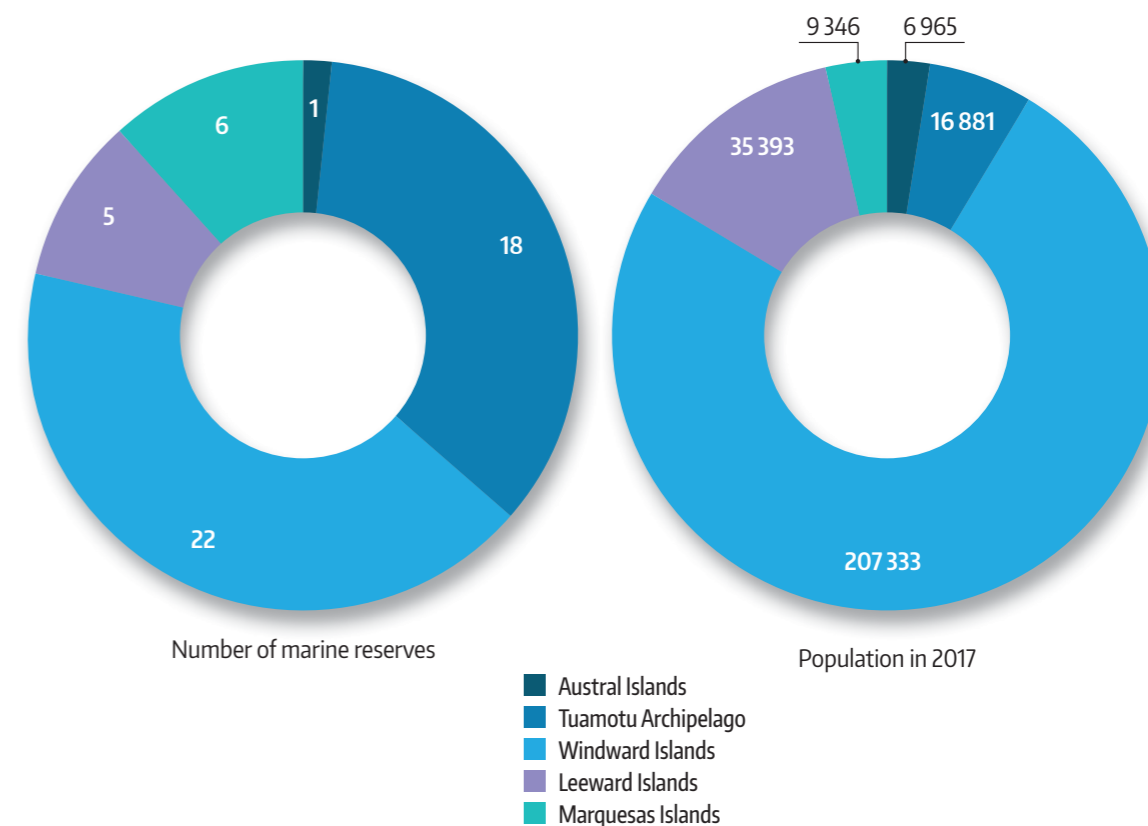

**Figure 12:** Number of reserves and population by sector in French Polynesia.

#### II.3.3. Wallis & Futuna

This OCT currently has no MPA, although their creation is currently being discussed.

#### II.3.4. Pitcairn Islands

Other than EEZ's classification as a strict nature reserve, there is no other type of MPA in this country.

### III HUMAN ACTIVITIES AND THE CURRENT MONITORING SYSTEMS

#### III.1. POPULATION SECURITY, GEO-STRATEGY, ILLEGAL ACTIVITIES, SEA RESCUE

##### III.1.1. French OCTs

In the Pacific Ocean, the main sea routes lie north of the Equator, whereas France's interests are south (Figure 13).

Illegal, unreported and unregulated (IUU) fishing and the illegal exploitation of resources are the main regional maritime threats. Also, the Pacific island region would seem to be a transit area for numerous drug trafficking networks between South America and Australia. This phenomenon affects, among others, French Polynesia, and to a lesser extent, New Caledonia.

More generally, monitoring protected marine areas to conserve resources in the French overseas EEZ is a major issue for this part of the globe.

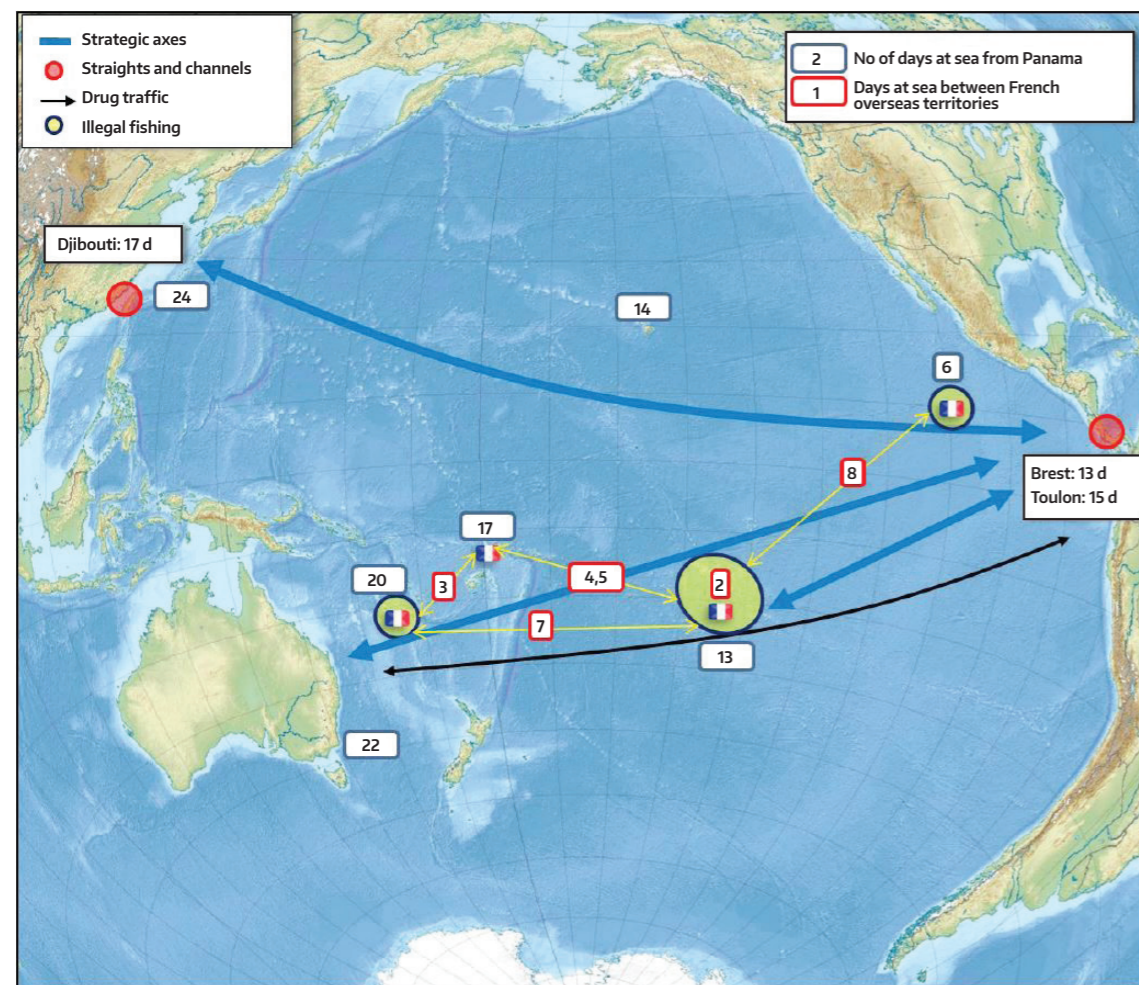

**Figure 13:** Sea routes, identification of areas with issues for the French OCTs in the Pacific island region (source: Anon 2015).

##### III.1.1.1. Missions of the Action de l'État en Mer (AEM)

The *Action de l'État en Mer* (AEM) is an administrative and operational organisation France has established to meet its obligations as a coastal and maritime State. The maritime areas under the AEM's responsibility include the areas placed under French jurisdiction as well as those governed by the high seas status for which France may exercise certain rights against its own vessels or against foreign or stateless vessels by virtue of International Agreements to which France is a signatory.

The administrative departments with the resources to take action at sea act within the context of the coastguard function. In particular, this includes the French navy, water police and customs. These departments, acting as a coordination power, provide the State's representative at sea with their resources to enable it to conduct the missions entrusted to it. This organisation also relies on the multi-purpose roles of the various naval and air resources of the coastguard's administrative departments with a view to providing effective and efficient service.

For the French OCTs, *Action de l'Etat en Mer* (AEM) includes the coordination actions of the administrative departments with competency at sea in order to provide an efficient response to any problematic situations liable to occur. The many missions of this service include:

- search and rescue at sea coordinated by the MRCC (Maritime Rescue Coordination Centre)
- monitoring and protecting national interests
- sea navigation safety
- combating illicit activities, in particular policing fisheries and drug trafficking
- assistance to vessels in difficulty and combating marine pollution.

##### III.1.1.2. New Caledonia and Wallis & Futuna

The missions of the New Caledonian branch of the AEM are clearly directed towards the issue of monitoring human activity within New Caledonia's EEZ maritime space as well as the EEZ of Wallis and Futuna.

Note that in New Caledonia, the area under the responsibility of the MRCC for search and rescue, called the Search and Rescue Region (SRR) is particularly vast as it extends beyond New Caledonia to the waters under the jurisdiction of Vanuatu by virtue of a bilateral agreement signed in 2004.

The AEM's missions reflect issues requiring a long-term monitoring strategy across a vast maritime area with significant resources (Figure 14).

The State services, in particular the Armed Forces of New Caledonia (FANC), have monitoring resources combining sea patrols and flyovers. On the other hand, the territory has no radar resources.



**2 P 400**  
*La Glorieuse & La Moqueuse*



**Maritime surveillance coastal launch**  
*Dumbéa*



**SNSM (Sea rescue)**  
1 launch - 3 semi-rigid inflatables



**Gendarmerie**  
2 Ecureuils helicopters /  
1 launch La Calédonienne



**Surveillance frigate**  
*Le Vendémiaire*



**Nature Guard Units**  
7 in the South Province and  
2 in the North Province



**2 GARDIAN aircraft**



**Helicopter**  
*Alouette III*



**2 CASA aircraft**



**3 PUMA helicopters**



**Department of Maritime Affairs**  
*Amborella*



**NC lighthouses and beacons**  
*Eugène Morignat*  
*Louis Hénin*

**Figure 14:** Monitoring resources of the Armed Forces in the New Caledonia – Also, the Entrecasteaux multi-mission vessel (B2M) not shown above (source: FANC).

**Figure 15:** Monitoring and intervention resources of the services and departments other than those of the FANC available in New Caledonia<sup>5</sup> (source: FANC).

<sup>5</sup> Some of these resources are not actually engaged in monitoring (sea rescue (SNSM), buoy tender, etc.) and do not participate in this mission. However, they may act as a source of additional information.

Despite the immense surface to be monitored and the relatively limited mobile monitoring resources, New Caledonia is renowned for its effectiveness at the regional level.

The State services work closely with the New Caledonian services, in particular the Maritime Affairs Department (DAM), which share to best effect their monitoring resources. Strengthening and maximising this synergy is reportedly currently on hold given the imminent deadlines concerning the country's institutional context (self-determination referendum scheduled for 2018).

As mentioned by the AEM, the current dynamic for creating protected marine areas in the Natural Park of Coral Sea further increases monitoring issues but may also modify its conditions. For example, monitoring within a strict nature reserve does not necessarily require identification resources (presence alone being forbidden), whereas monitoring a natural reserve where some activities are authorised requires access to far more information.

In order to carry out its monitoring missions of human activities at area, the State's service's technological systems overlap:

- VMS<sup>6</sup> data from the New Caledonian oceanic fishing fleet collected by the New Caledonian Maritime Affairs Department
- data from VMS systems introduced by regional organisations (FFA<sup>7</sup>, WCPFC<sup>8</sup>) to monitor high seas pockets
- public AIS<sup>9</sup> data monitored by the MRCC and operations central command (Armed Forces)
- EEZ entry/exit declaration data received by the National Centre for Fisheries Monitoring and/or the New Caledonian Department of Maritime Affairs
- the occasional on-demand use of very high resolution (70 cm) satellite imaging over areas measuring 40 x 40 km to gain additional information or confirm a suspicious situation (service provided by the TRIMARAN satellite monitoring system with an operational delay of 36 hours). At present, the Spationav V3 tracking system is being tested in Continental France and should soon be available for use by overseas territories.
- the use of surface radar installed on a Gardian aircraft.

In terms of monitoring, New Caledonia enjoys a particular situation with very few illegal activities overall up until 2016, followed by an increase in instances of illegal fishing by Vietnamese boats (blue boats), as well as several cases of drug trafficking.



**Figure 16: Armed Forces interception of Vietnamese blue boats illegally fishing in the New Caledonian EEZ** (source: www.colsbleus.fr).

<sup>6</sup> *Vessel Monitoring Systems*, cf. chapitre III.2.1

<sup>7</sup> *Fisheries Forum Agency*, cf. chapitre III.2.1

<sup>8</sup> *Western and Central Pacific Fisheries Commission*

<sup>9</sup> *Automatic Identification System*, cf. chapitre III.3

Between 1 June 2016 and December 2017, the AEM's response, working jointly with the FFA and AFMA (Australian Fishery Management Authority), led to the interception of 20 blue boats (nine of which were rerouted away and 11 seized) illegally fishing sea cucumbers in remote reef areas (Chesterfield and d'Entrecasteaux reefs in particular). The cumulative catch seized was 35.7 tonnes of sea cucumbers over 10 operations. These field actions were also the subject of a strong joint diplomatic response:

- a yellow card from the European Commission (10/2017) to Vietnam threatening, in the absence of any positive reaction, to stop imports of its fishing products into the EU
- the signature of a memorandum (08/2017) between Vietnam and Australia in order to implement long-term cooperation to combat illegal fishing.

These diplomatic responses combined with effective monitoring cooperation of illegal activity seem to be working so far as no illegal Vietnamese boat has been identified since December 2017.

### III.1.1.3. French Polynesia

In French Polynesia, the AEM also relies on the resources and expertise of several administrative departments, in particular: the Armed Forces, police, maritime affairs and customs.

Since September 2011, in exercising its missions, it has benefited from an upgraded and improved monitoring system. At the French Polynesia Shared Maritime Centre (CMC-PF), the State services fully utilise the tools available to them and implement a monitoring strategy designed around the analysis of electronic signals emitted by vessels and satellite images. Monitoring is conducted from a maritime information fusion centre (CFIM - Figure 18) which, with the MRCC, forms the CMC-PF. The latter relies in particular on:

- access to VMS data which corresponds to the signals that Polynesian and foreign fishing vessels must emit. These signals are used to precisely track and help detect suspicious behaviour (intermittent disappearance of the signal, fishing routes characteristic of illegal fishing activity, etc.)
- the content and analysis of AIS transmissions which are not systematically mandatory<sup>10</sup> but are used by most freight, cruise and fishing vessels and by around two thirds of pleasure craft
- satellite imaging, trialled since 2014, is also used if required to obtain targeted radar or optical images and detect all vessels within a given maritime area. This service called TRIMARAN is provided by *Telespazio France and Airbus Defence and Space*<sup>11</sup>.

This permanent monitoring activity provides in-depth knowledge of shipping flows and also makes it possible to improve how the traditional monitoring and control systems available to AEM in French Polynesia are targeted (Table 9). The routine use of these onshore resources helps in particular improve mission targeting for the Gardian aircraft and French Navy's vessels. The Gardian aircraft conduct a surveillance flight or sea operation flight once a week on average. They are primarily directed towards areas with a high concentration of foreign vessels, often around the immediate EEZ boundary (these are vessels being banned from fishing within the EEZ). This system is efficient, visible and non-predictable which makes it apparent and dissuasive, since foreign fishing fleets are aware that they are being monitored. Controls are therefore often conducted in the open sea outside the EEZ to dissuade any attempted incursion. These controls are conducted in compliance with applicable international rules (in particular the resolutions of the

<sup>10</sup> See chapter III.3

<sup>11</sup> <https://www.intelligence-airbusds.com/fr/7169-airbus-defence-et-space-et-telespazio-france-selectionnes-pour-fournir-un-service-de-surveillance-maritime-par-satellite-a-la-marine-nationale-franca>



Western and Central Pacific Fisheries Commission, WCPFC) and often result in procedures being addressed to the States from where the contravening fishing vessels originate. These maritime surveillance operations conducted in cooperation with neighbouring States and France's main partners in the Pacific are regularly carried out in the maritime area of French Polynesia but also of New Caledonia.



**Figure 17:** Maritime information fusion centre at the French Polynesia shared maritime centre.

**Table 9:** AEM's monitoring resources in French Polynesia.

Maritime resources	Air resources
1 surveillance frigate, <i>Prairial</i> , and its onboard helicopter, <i>Alouette III</i>	2 Gardian type maritime surveillance aircraft (25F fleet)
1 high sea patrol vessel, <i>Arago</i>	2 Dauphin N3+ inter-ministerial helicopters (35F fleet)
1 multi-mission vessel (B2M), <i>Bougainville</i>	2 Air Force Casa transport planes (ET 82)
2 port and coastal tugs, <i>Manini</i> and <i>Maroa</i>	
1 Maritime Gendarmerie patrol vessel, <i>Jasmin</i>	

### III.1.2. British OCTs – Pitcairn Islands

The Pitcairn Islands are the only British overseas territory in the Pacific Ocean. They are a group of four islands (Pitcairn, Henderson, Ducie and Oeno), with a combined land area of 47 km<sup>2</sup>. The EEZ has since 2016 officially been a strict nature reserve where fishing is banned. Non-professional fishing activity is however still authorised in the territorial waters off the Pitcairn islands, of which Pitcairn is the only inhabited island with a population of 52 (Figure 18). In the absence of any specific air or sea surveillance resources, the British government has opted to implement surveillance of the reserve using the services of the Catapult satellite app after a test period lasting more than a year and called "Project Eyes on the Seas".

As part of this experimental approach, an unmanned surface vehicle (USV) will be added to the panel of technology used (Figure 19). This Wave Glider was equipped with key sensors (AIS receiver, acoustic sensor and camera) to detect and identify any vessels present in the area (including any not emitting signals). This onsite photographic identification technique is now used to make a link between a vessel's name or flag, unlike satellite images alone (Figure 20).

More generally, this pilot programme made it possible to assess the efficacy of the Eyes on the Seas project and the technologies used to monitor large isolated marine protected areas. It demonstrated the ability of this combination of technology to identify vessels fishing in areas where it is banned, and to develop a model for a durable and effective surveillance programme for the Pitcairn Islands Marine Reserve.

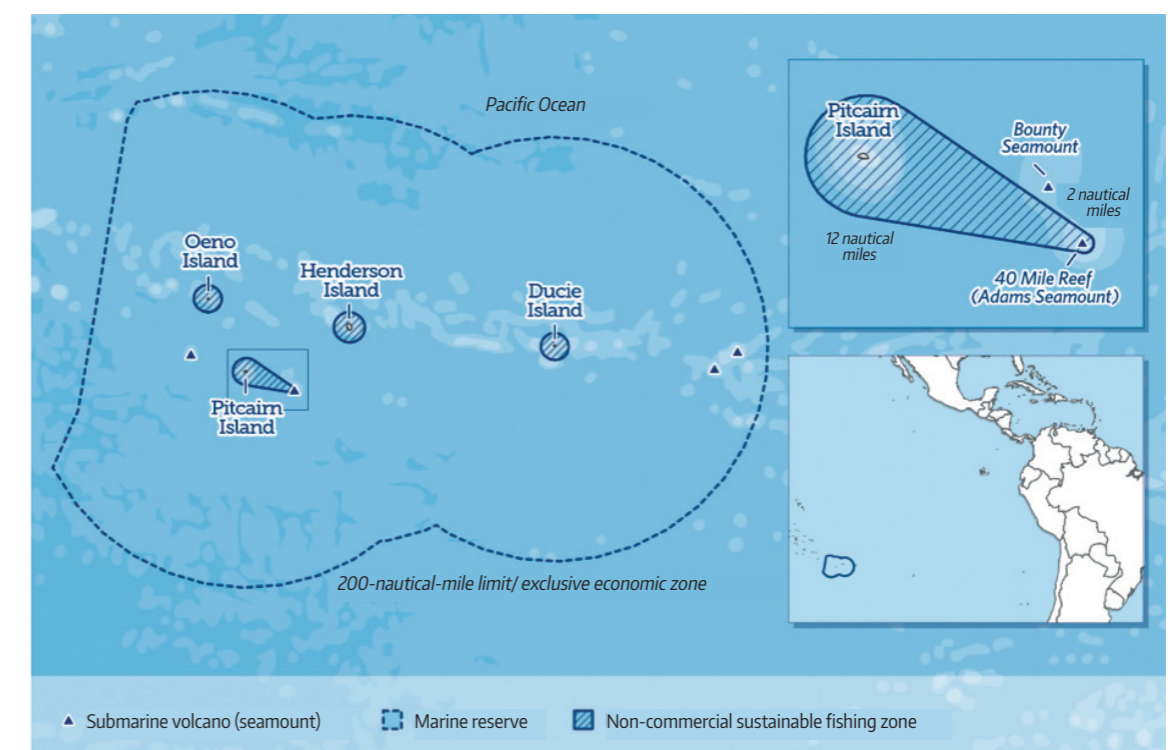

**Figure 18:** Boundary of the EEZ and the Pitcairn Islands Maritime Reserve (source: The Pew Charitable Trusts).

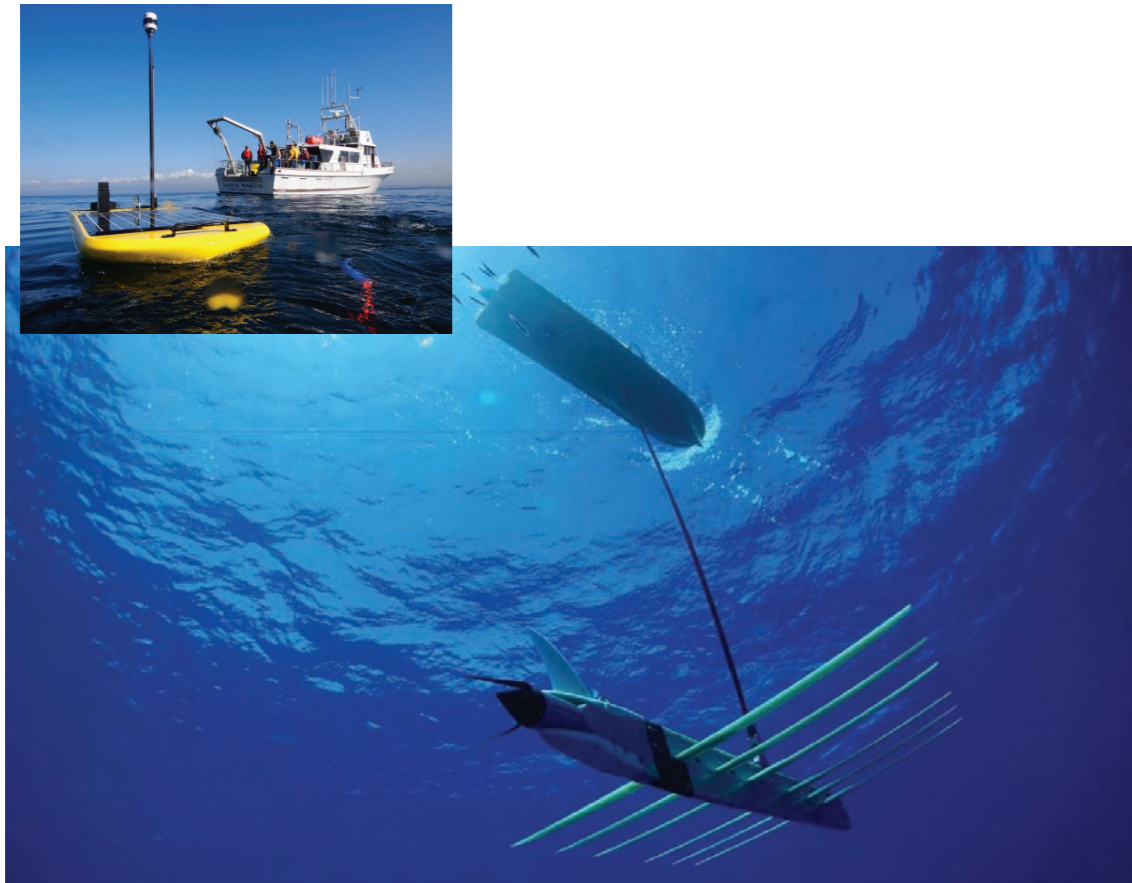

**Figure 19:** Unmanned surface vehicle (USV) (Wave Glider by Liquid Robotics) uses wave and solar energy (source: Liquid Robotics).



*Vessel captured by Wave Glider camera and sent by Iridium satellite. High-res images available when bandwidth permits.*

**Figure 20:** Photograph captured by the Wave Glider camera and sent by satellite (source: Liquid Robotics).

## III.2. FISHING ACTIVITIES IN PACIFIC ISLAND COUNTRIES AND TERRITORIES

### III.2.1. Context of fishing activities in Pacific island countries and territories

In Pacific islands, the sustainable exploitation of marine resources is a crucial issue as fish is a prime subsistence and commercial activity for this region. A distinction needs to be made between (Figure 21):

- **Oceanic fishing:** an activity conducted offshore and mainly in the EEZ outside territorial waters, and requiring vessels larger than 15 metres. There are around 1,500 vessels in this category in the Pacific islands mainly for purse seine fishing, longline and rod fishing mainly targeting tuna species.
- **Coastal fishing:** an activity targeting a very broad range of fish, invertebrate and algae resources. It includes:
  - coastal fishing, in the strict sense of the term, practised off the coast of the islands, especially around fish-aggregating devices (FAD) or around shoals.
  - reef-lagoon fishing, generally in shallow habitats in lagoons, reefs or the external slopes of reefs. There are many lagoon fishing methods reflecting the diversity of targeted species. To mention just a few, these methods include tidal gathering, free diving from a boat (not necessarily motorised), spearfishing, shellfish collecting, traps, nets, rod and line.

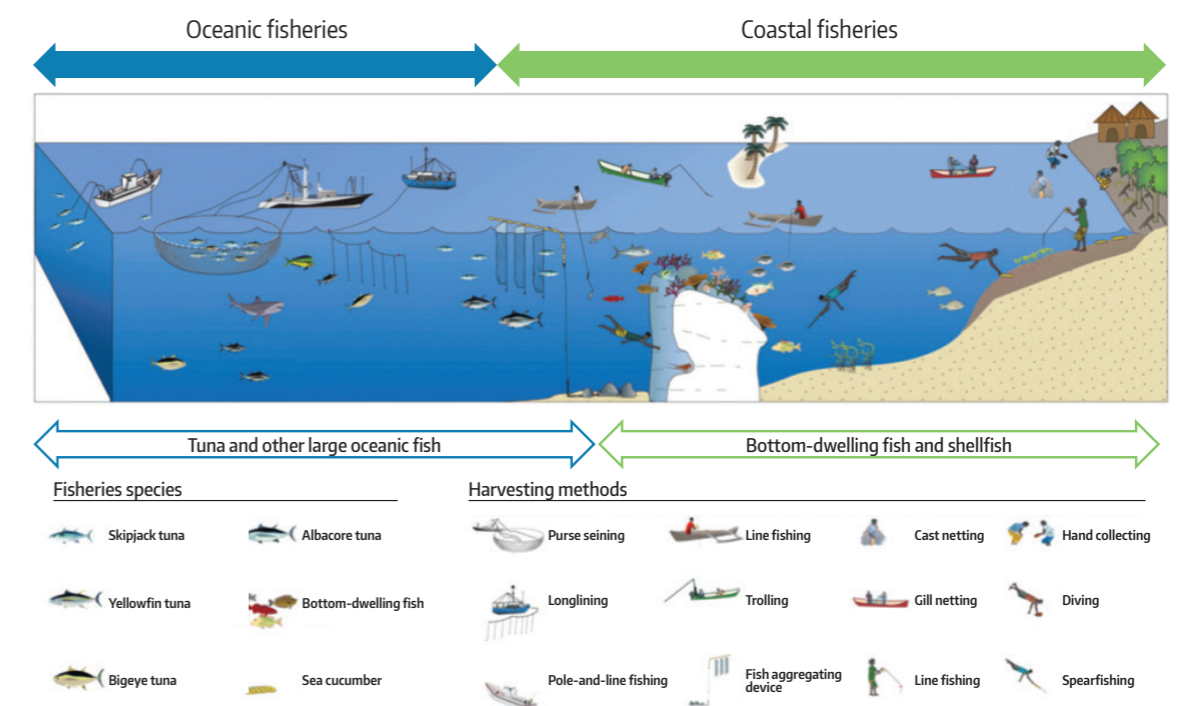

**Figure 21:** Diversity of coastal (Coastal fisheries) and deep-sea (Oceanic fisheries) fishing in Pacific island countries and territories (source: after CPS).

In terms of monitoring, coastal and oceanic fisheries would seem to be completely different in terms both of the size of the boats used, number of operators, resources targeted and fishing areas (location and surface areas).

In his report "Fisheries in the Economies of the Pacific Island Countries" (Gillett 2016) makes a distinction between *professional coastal fishing* and *non-professional coastal fishing*. The latter is termed "subsistence fishing" by Gillett 2016 but in fact also includes recreational fishing (in addition to subsistence fishing in the strict sense of the term). In this report, this terminology has been adopted to remain consistent with that used throughout most OCTs, as well as with monitoring issues which would appear to differ depending on whether referring to regulated professional fishing supported by a fisheries service or an informal activity practised by the population.

For Oceania fisheries, a distinction is made between *local industrial tuna fishing*, for which the boats are based in a port of the country where the activity is practised, and *foreign industrial tuna fishing* with a home port outside the country and for which the activity is based on the sale of fishing rights. In this respect, and contrary to some other Pacific island countries and territories (Figure 22 and Figure 23), there is a consistent protectionist policy between the four European Pacific island OCTs (NC, PF, WF and PTC), which no longer issue any fishing licenses to foreign vessels. This decision actually facilitates the identification and tracking of illegal activity in their respective EEZs.

For the 22 Pacific island countries and territories, the catch for Oceania fisheries is eight times greater than the catch from coastal fisheries. However, the region's countries and territories have widely differing fishery production (in terms of volume and value, Figure 23), because of natural contextual factors affecting the size of stocks (extent of their EEZ, presence of more or less favourable habitats for the targeted species), and human factors (privileged fishery practices, level of industry development, size of fishing fleets, etc.).

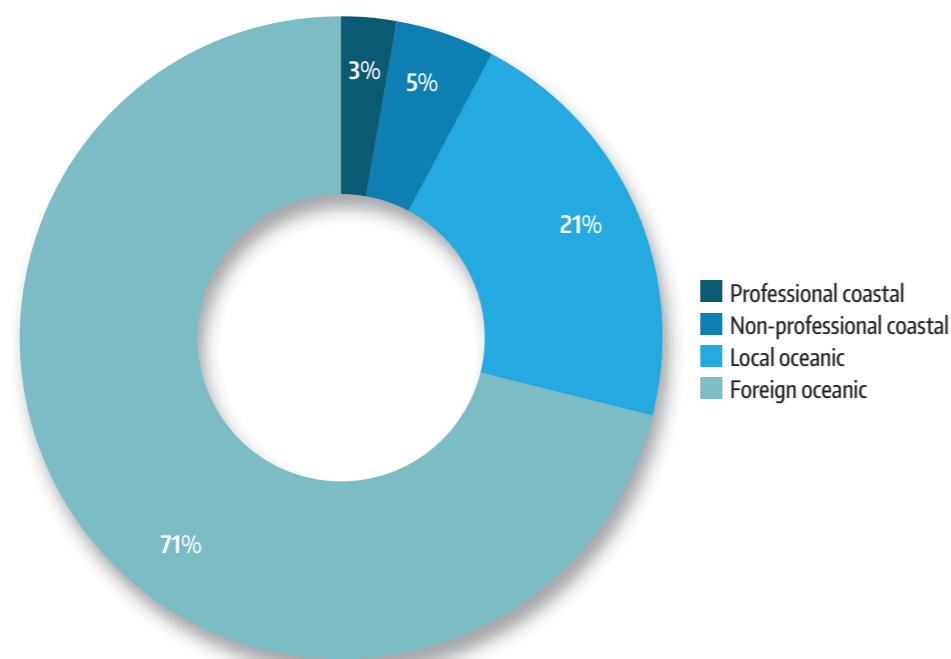

**Figure 22: Contribution of the various types of fisheries to the total volume catch for the 22 Pacific island countries and territories** (source: after Gillett 2016).

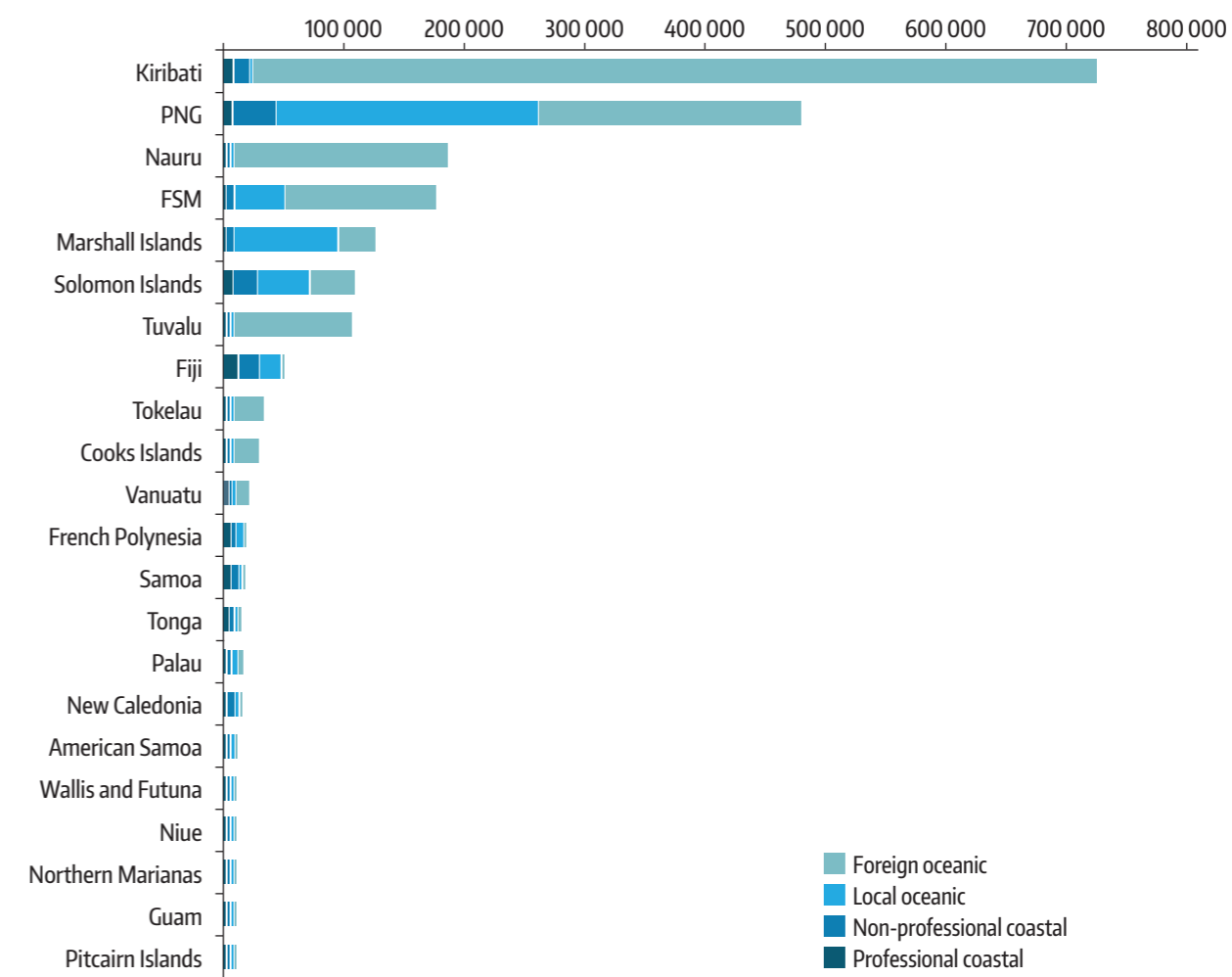

**Figure 23: Volume (in tonnes) of fisheries catches for the Pacific island countries and territories** (source: after Gillett 2016).

The management of stocks of highly migratory species, such as tunas, shared between several Pacific countries and territories, can only be effective if it is addressed at a coherent regional level taking into account the dynamic of these stocks, and conducted jointly by the countries and territories concerned. The presence of vast extents under international jurisdiction (high seas area in Figure 2), interspaced between the region's EEZ but also the variable approaches by the countries and territories in terms of fisheries policy, significantly complicate efforts to manage the exploitation of these stocks at the regional level. The Pacific island countries have two regional organisations with significant involvement in helping support management and tracking of fisheries activities:

- the Pacific Community (SPC: [www.spc.int](http://www.spc.int)), based in Noumea, New Caledonia, helps the member countries and territories to manage and develop their coastal and oceanic fisheries
- the Pacific Islands Forum Fisheries Agency (FFA: [www.ffa.int](http://www.ffa.int)), based in Honiara, Solomon Islands, helps member countries manage their tuna resource in terms both of economics and monitoring.

At a technological level, the VMS system, regulatory and mandatory in most national professional fisheries and oceanic fisheries, provides the Pacific countries and territories with a fishing vessel surveillance system. It transmits vessel position, route and speed data to fishing authorities (Figure 24). Additionally, foreign fishing vessels must be equipped with a satellite location system in working order when they are located in the maritime area of a different flag state.

The FFA also monitors its member states' compliance with fishery regulations<sup>12</sup>.

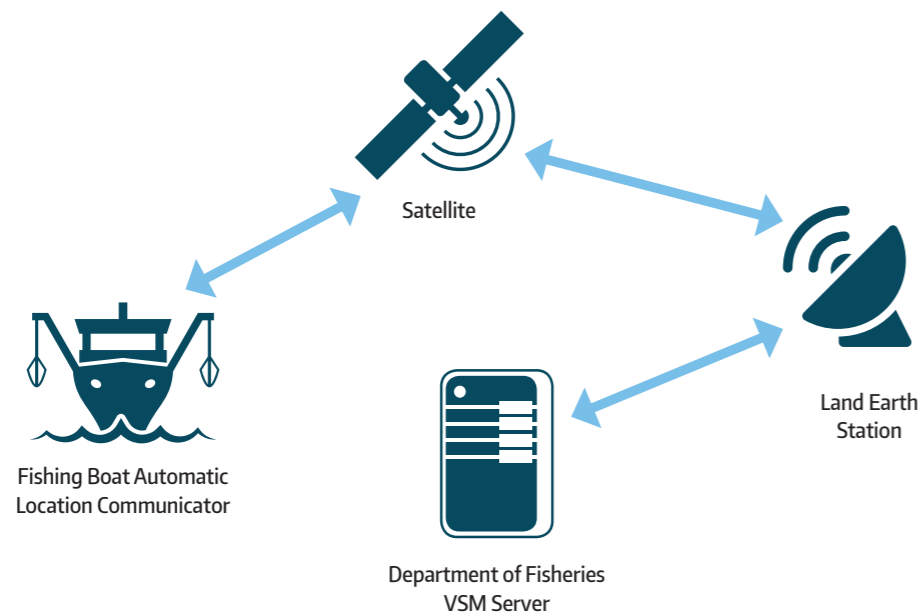

**Figure 24:** Illustration of the VMS fishing vessel monitoring chain.

### III.2.2. Importance of fishing and aquaculture for Pacific OTCs

#### III.2.2.1. Comparative fisheries and aquaculture production data for the four OTCs studied

The economy of most Pacific Islands is based on the exploitation of natural resources, in particular fishing and aquaculture fisheries resources. This statement needs to be nuanced against the specific context of each of the four Pacific OTCs, for which the volume and value of production varies significantly<sup>13</sup> (Figure 25 and Table 10).

<sup>12</sup> <http://www.fao.org/fishery/topic/18074/en>

<sup>13</sup> These figures are extracted from the Gillet 2016 report on the fisheries economy of Pacific Island countries and territories. Certain differences compared with the most recent official statistics for each OTC may therefore be possible, and can be explained by the detailed assessment methods used in the reference document: Gillet, R. (2016). *Fisheries in the Economies of Pacific Island Countries and Territories*. Secretariat of the Pacific Community, Noumea, 664 pages.

Preference has been given to using these figures for presenting the general context of fisheries at the regional level, in order to provide comparable orders of magnitude between the four OTCs (the detailed fisheries statistics for the various OTCs use heterogeneous categories and variable assessment methods that are ill-suited for direct comparisons).

**Table 10:** Volume (in tonnes) of fisheries production and aquaculture production for the four European Pacific OTCs (source: after Gillett 2016).

	Pitcairn	French Polynesia	New Caledonia	Wallis & Futuna
Professional coastal	3	5,666	1,350	150
Non-professional coastal*	6	2,350	3,500	675
Oceanic	-	5,390	2,876	-
Aquaculture	-	101	1,733	-

\*Called "subsistence fishing" in Gillett 2016 but also includes recreational fishing

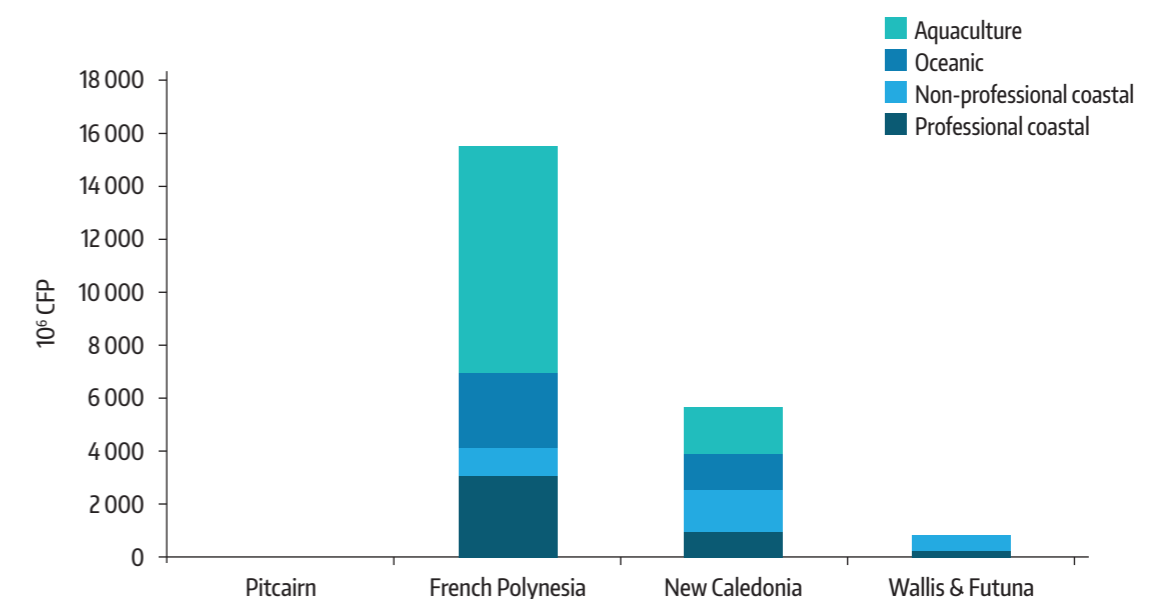
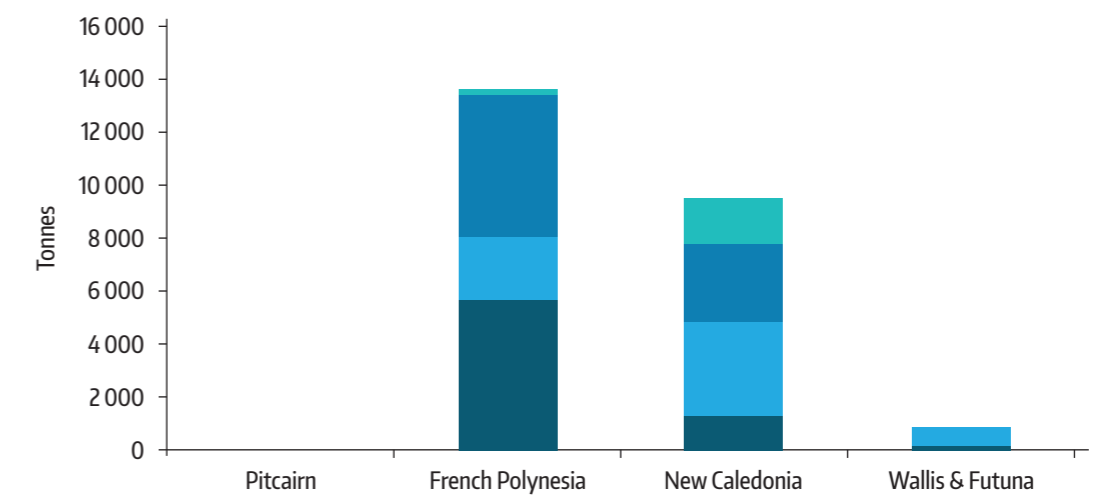

**Figure 25:** Volume (tonnes) and value (XPF millions) of fish catches and aquaculture production in the four European Pacific OTCs (source: after Gillet 2016, value converted at the rate of USD1 = XPF100).

### III.2.2.2. Pitcairn Islands

In the Pitcairn Islands, fisheries production is exclusively coastal. Totalling less than 10 tonnes/year, it is mainly for local consumption. One-third of the annual production is sold to the several hundred tourists disembarking from cruise ships (616 tourists in 2016). The absence of any oceanic production is consistent with the recent creation of a strict nature reserve covering the islands' entire EEZ.

### III.2.2.3. Wallis & Futuna

The fisheries situation in Wallis and Futuna is similar to that in the Pitcairn Islands. The economy is still today largely traditional and non-monetary. More than 8% of production is consumed locally and commercial trade is still limited. Despite a definite fisheries potential, the absence of any oceanic production (since 2012) is attributable to the lack of any local fleet and a protectionist policy concerning the sale of fishing rights in the EEZ to foreign boats.

### III.2.2.4. New Caledonia

In New Caledonia, fisheries production is higher than in the two preceding OCTs but accounts for less than 0.4% of this territory's GDP (Gillett 2016), as the economy is principally based on the exploitation of mineral resources, especially nickel.

Coastal fishing accounts for more than half the volume of seafood products (aquaculture and fisheries) with a cumulative total estimated by Gillett (2016) at 4,850 tonnes. This coastal and reef-lagoon production is mainly consumed locally. Coastal production by the professional sector involves small boats of which there were 167 in 2015.

Since 2001, oceanic activity is entirely conducted by the local fleet of 17 longliners measuring between 20 and 30 metres (Figure 28), targeting tuna and committed to the New Caledonian *Pêche Responsable* (responsible fisheries) certification. Almost 70% of the catch, totalling 2,483 tonnes in 2016, is sold on the local market while the remaining 30% is shipped to Japan, Pacific canneries and the European market.

This total fisheries production quoted for New Caledonia does not take into account scallop (*Amusium ballotti*) gathering which was resumed in 2015 in the Grand Lagon Nord off the Bélép Islands (North Province).

Aquaculture production is significant and basically concerns vampire shrimp (inland water along the coastal area). Driven by political commitment and local development programmes (in particular through ADECAL-Technopole<sup>14</sup>), the aquaculture industry is tending to diversify into new types of production although with relatively modest volumes, such as oysters and sea cucumbers.



**Figure 26:** Illustration of the French Polynesia fishing port (left) and the fisheries wharf of the Autonomous Port of New Caledonia (source: Papeete Autonomous Port and New Caledonia Department of Maritime Affairs).

### III.2.2.5. French Polynesia

French Polynesia's third most important resource, fisheries, accounts for 11% of Polynesia's exports (XPF 1.2 billion in 2016). The exported production mainly comes from the oceanic fisheries sector which has a fleet of 59 tuna vessels (between 16 and above 20 metres), committed to the MSC (Marine Stewardship Council) quality labelling process.

Over the last decade, the volume of the catch has remained relatively stable at around 6,000 tonnes (5,930 tonnes on average between 2007 and 2016). A master plan for the industry for the coming decade has been adopted by the government and aims to double production within a decade.

Gillet (2016) estimates non-professional fishing at 2,350 tonnes, and is still officially less than the professional catch (5,666 tonnes). This volume breaks down into 3,516 tonnes from non-lagoon coastal fishing, and around 2,150 tonnes from professional lagoon fishing. Coastal professional fishing in French Polynesia is particularly well developed: in 2016, the sector had 40 bonito vessels (between 10 and 12 metres) and 384 typically Polynesian boats called *Poti marara*<sup>15</sup> (between six and eight metres). The professional coastal fishing fleet is mainly located in the Windward Islands (Tahiti and Moorea - Figure 27).

French Polynesia has managed to diversify its economy by developing tourism, fishing, agriculture and the culture of black pearls. Marginal compared to the income from pearl culture, aquaculture basically involves shrimp farming (89 tonnes) and marine fish culture (12 tonnes - *Platax orbicularis*). There is still a potential increase in production of shrimp in the sea, as annual consumption (> 500 tonnes) still requires imports. It could also benefit from the arrival of Chinese investment to develop this industry, in particular through the creation of an aquaculture centre (Tahiti Nui Ocean Foods) in the Tuamotu Archipelago which eventually aims to achieve production of 50,000 tonnes. An aquaculture masterplan co-funded by the French Development Agency (AFD) is also expected to be released in 2018.

<sup>14</sup> ADECAL New Caledonia Economic Development Agency <http://www.technopole.nc>

<sup>15</sup> A *poti marara* is a boat with a V-shaped hull adapted to cut through waves in the open sea. It has a cockpit in the front equipped with a large "joy stick".

While the contribution in the tonnage terms from the production of pearls is negligible, its value contribution is significant (Figure 25). This production, involving 581 pearl growers over a cumulative authorised surface area of 7,752 hectares is mainly located on the Tuamotu Archipelago and in Gambier Islands (SPE). The cumulative income from aquaculture in the Pacific island region is dominated by French Polynesia (USD1.56 billion, mainly black pearls) and New Caledonia (USD250 million, mainly shrimp), representing 95.5% of the value of aquaculture in the 22 Pacific island countries and territories.

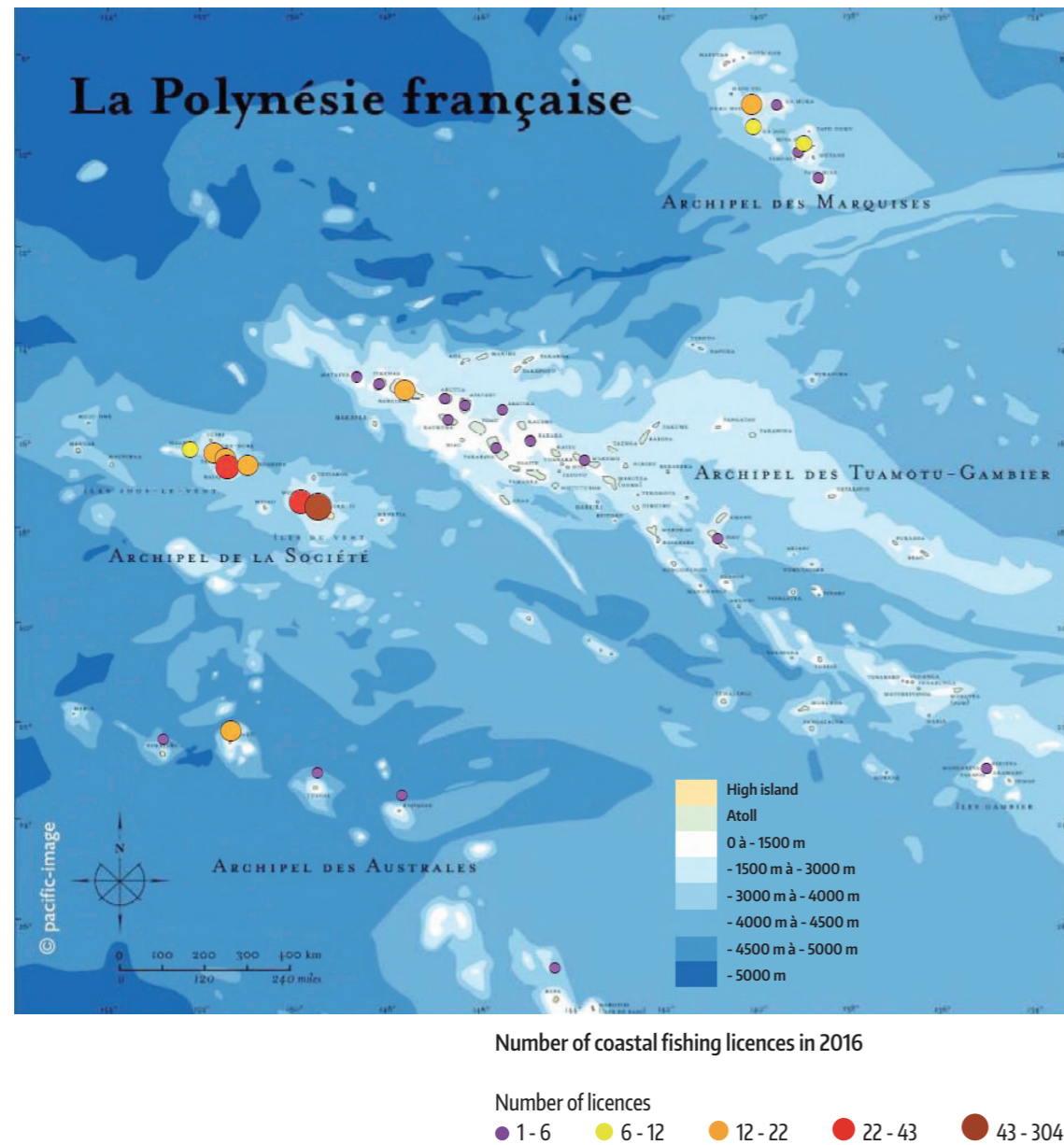

**Figure 27:** Geographic distribution of coastal fishing licences in French Polynesia in 2016 (source: DRMM PF 2016).

### III.2.3. Existing technologies used for oceanic fishing

Along with the VMS system (Figure 24), regulatory and mandatory in most national professional fisheries and oceanic fisheries, other technological solutions are currently being rolled out in the region and in the Pacific OCTs for monitoring fishing vessels.

An analysis conducted in 2016 by the FFA showed that the non-declaration, incorrect declaration and under declaration of catches accounted for the majority of so-called illegal fishing, USD600 million for the region. The reliability and traceability of data is crucial for the sound management of fisheries, and various technologies are now available to combat illegal, undeclared or non-regulatory fishing while ensuring the sustainable development of these sectors.

Over the past five years, the Pacific Community (SPC) has worked with its member countries, fisheries management agencies, the fishing industry, technology suppliers and non-governmental organisations (NGOs) to design, build and test new monitoring tools.

In particular, e-Reporting systems (Figure 29) are used routinely to collect electronic data as part of pelagic fish stock management. The stated targeted aim is to gradually replace the logbooks carried by fishing vessels and used by observers (onboard or at port) with e-Reporting technology (Figure 28). This technology has numerous advantages, as it enables a more reliable and faster transmission of data directly while at sea if the vessels are equipped with satellite connection or as soon as a mobile or Wi-Fi network is within reach. The technology can also be used to link information from the ship's logbook, the fishing observer's and the port inspector's reports resulting in quality data control and greater efficiency in its use for managing fisheries. Considerable funding has been provided by non-governmental organisations, such as WWF, PEW Charitable Trusts, the Nature Conservancy and Seafood Sustainability Foundation, to assist with the development of this technology, essentially conducted by the SPC in conjunction with independent technology suppliers (SPC, 2017). This support has enabled the SPC member countries to create jobs specifically for research and the development of these new tools and associated database systems, the purchase of hardware (tablets and satellite transmission systems), and regional training and workshops.

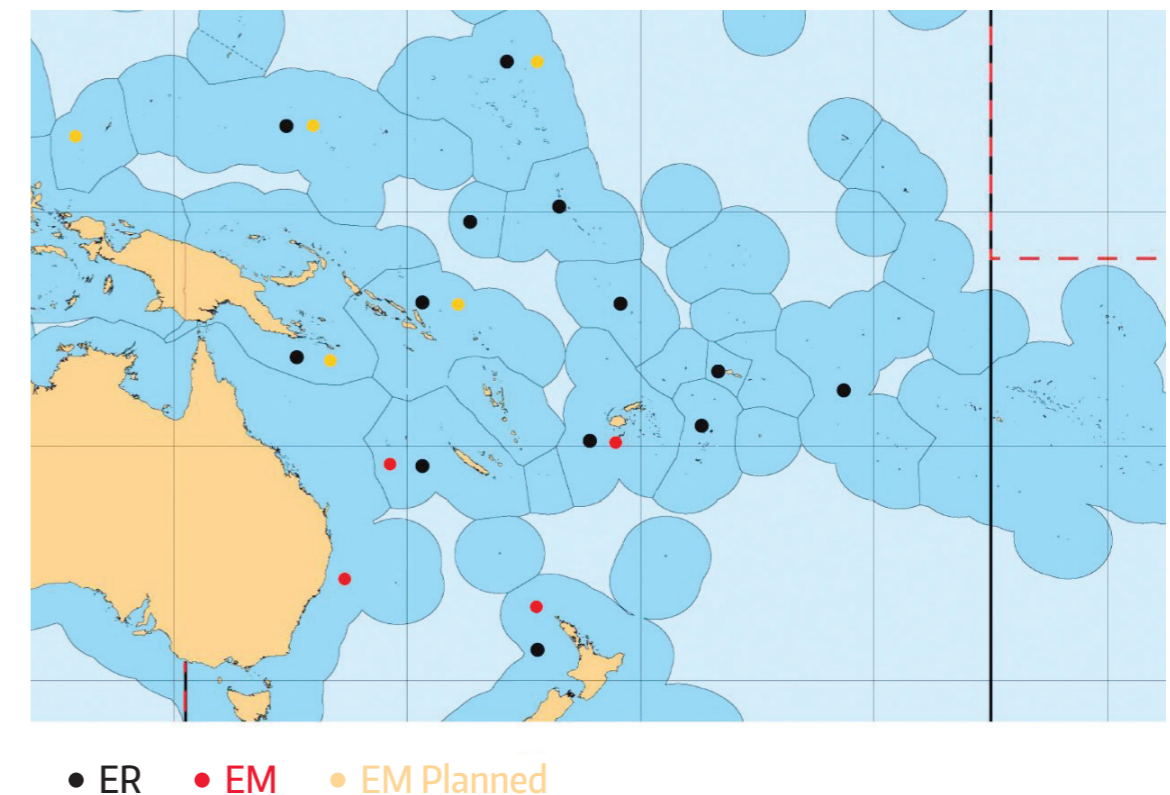

**Figure 28:** Location of areas where technological tracking actions based on e-Reporting (ER) and e-Monitoring (EM) have been implemented (source: SPC 2016).

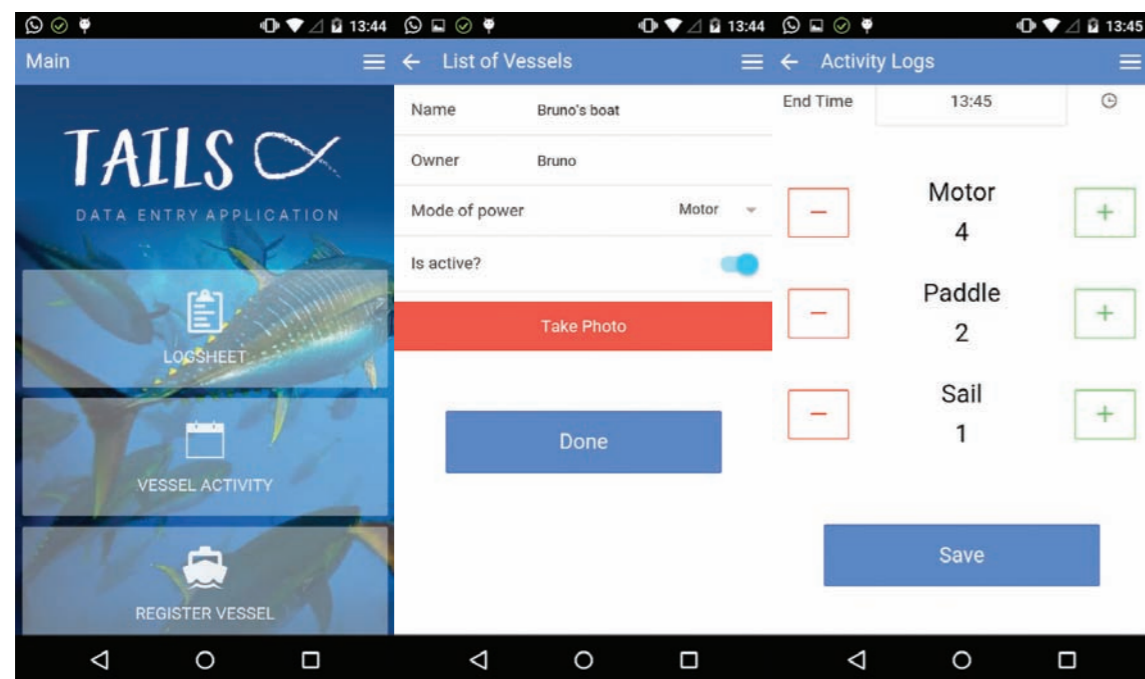

**Figure 29:** Screen capture of the Oceanic Fisheries Program's Tails app for entering fishing data in the WCPFC area (source: SPC).

The e-Monitoring System (EMS) uses video cameras and sensors to monitor and record fishing activity in the field (Figure 28). Comparing the data acquired against the fishing data actually declared can be used to check its quality and reliability. This type of e-monitoring is helping improve the overall quality of fishing data and so scientific assessments and decision-making.

The EMS technology is used routinely today, in particular to monitor tuna fishing in Australia (Eastern and Western Tuna and Billfish fisheries). It has been assessed by the SPC in several Pacific island countries and territories, as well as in two regional workshops with the FFA. The aim is to define standardised procedures in order to roll out this technology, now considered as tried-and-tested for the collection of data required by the WCPFC tuna commission. So far, the interpretation of the data entered is still by and large manual, and the introduction of automated procedures using artificial intelligence should soon become a new tool benefiting e-monitoring (source: 2<sup>nd</sup> MCS Emerging Technologies Workshop<sup>16</sup>)

### III.2.1. Existing technology used for coastal fishing

Professional reef-lagoon and coastal fishing activity is subject to monitoring, management and control by management authorities specific to each OCT. These activities are generally the subject of declaration tracking imposed by the relevant fisheries authorities (Table 2) as part of their respective regulations.

This declaration tracking takes the form of fishing logbooks, filled out by the fishers to describe their fishing activity (efforts and catches, location of their activities, etc.), and collected into monthly or annual databases (most often linked to the renewal of fishing licenses). Although they are essential for managing fisheries activities and stocks, the level of detail in the data recorded by fishers and the return rate of logbooks to the fisheries services would seem extremely variable from one country, territory or province to another. The methods for entering, archiving and processing the data collected by the management authorities (e.g., existence of a specific and secure database, data processing protocols for producing activity and resource exploitation indicators) would seem extremely variable.

Subject to its appropriate size and successful support by the fisheries authorities, this type of declarative system may prove satisfactory for the long-term management of resources or fishing fleets. However, it is not really a monitoring system, in particular with regards to its reactivity (data compiled annually) or its spatial precision (non-existent or imprecise spatial data), and the technological solutions designed to monitor coastal fishing vessels would currently seem to be non-existent in Pacific Island OCTs.

Several emerging initiatives in the Pacific region and included in SPC reports aimed at improving this aspect of monitoring in coastal areas are worth mentioning:

- tests for using VMS to monitor coastal fishing vessels in Tonga (without any minimum vessel size)
- tests for using VMS on the four aquarium fish fishing vessels in Fiji
- tests for monitoring small coastal fishing vessels from an observatory with a telescope in Palau.

Pending feedback from these pilot projects, these examples of applications show that there are opportunities to support the development and management of coastal fisheries using simple monitoring technology.

Although the human and financial resources available between the oceanic and coastal sectors is difficult to compare, the progress recently made in monitoring oceanic fishing should be beneficial to the coastal sector as well through the gradual transfer and adaptation of technology that has now been tried and tested and its application mastered.

<sup>16</sup> Link to the workshop documents: 2016 MCS Emerging Technologies Workshop

### III.3. MARINE TRANSPORT

The Pacific Ocean occupies a central role in global international and domestic transport. Stimulated by global trade, international navigation has increased significantly over the past 20 years, with almost four times as many vessels at sea. The Pacific Ocean has seen its marine traffic increase significantly since 2018, especially near China, with the development of freight trade which is largely supporting growth in this region (Tournadre 2014, Kinch et al. 2010).

By way of example, in a New Caledonia, marine transport accounts for 50% of the national overseas traffic, in particular due to industrial activity (Figure 31). As elsewhere in the world, this activity in particular involves container ships and cruise ships. However, according to a 2015 report by the Government of New Caledonia<sup>17</sup>, three-quarters of the ships identified over the past five years in the New Caledonian maritime area carried a foreign flag.

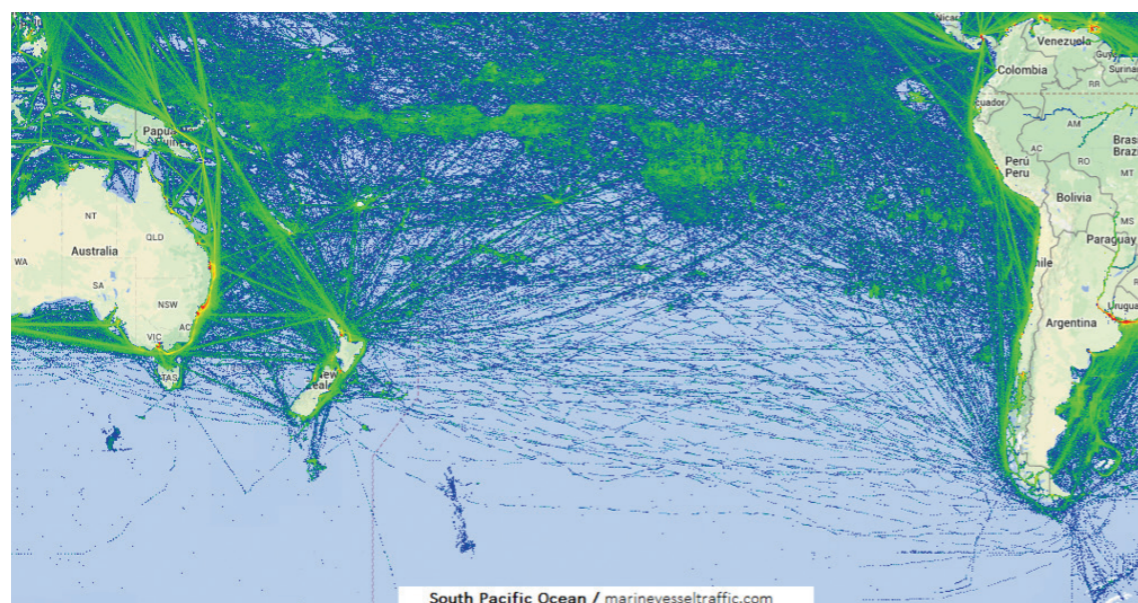

Figure 30: AIS tracking of marine traffic in the South Pacific (source: www.marinevesseltraffic.com).

Table 11: Detail of international traffic in 2017 for New Caledonia (source: after PANC & MRCC 2017).

	Passenger vessels	RORO	Container ship	Ore carriers	General cargo	Other	Oil tanker	Chemical tanker	Gas tankers	Fishing vessels	Total
Jan	97	8	55	29	7	0	11	0	6	0	213
Feb	77	7	47	21	7	1	13	0	6	2	181
March	79	8	55	31	9	1	5	0	3	9	200
April	68	6	62	48	9	1	14	0	4	2	214
May	40	5	68	45	3	1	14	0	3	4	183
June	37	10	64	25	0	7	6	0	10	26	185
July	43	8	67	29	1	0	14	1	4	0	167
August	35	8	60	32	2	0	11	0	4	3	155
Sept	36	10	79	29	1	0	10	0	4	4	170
Oct	67	6	61	50	1	0	10	0	4	2	201
Nov	62	5	60	45	1	0	10	0	2	0	185
Dec	89	5	54	36	0	0	14	0	4	0	202
<b>Total</b>	<b>730</b>	<b>85</b>	<b>730</b>	<b>416</b>	<b>41</b>	<b>131</b>	<b>131</b>	<b>1</b>	<b>55</b>	<b>52</b>	<b>2 241</b>

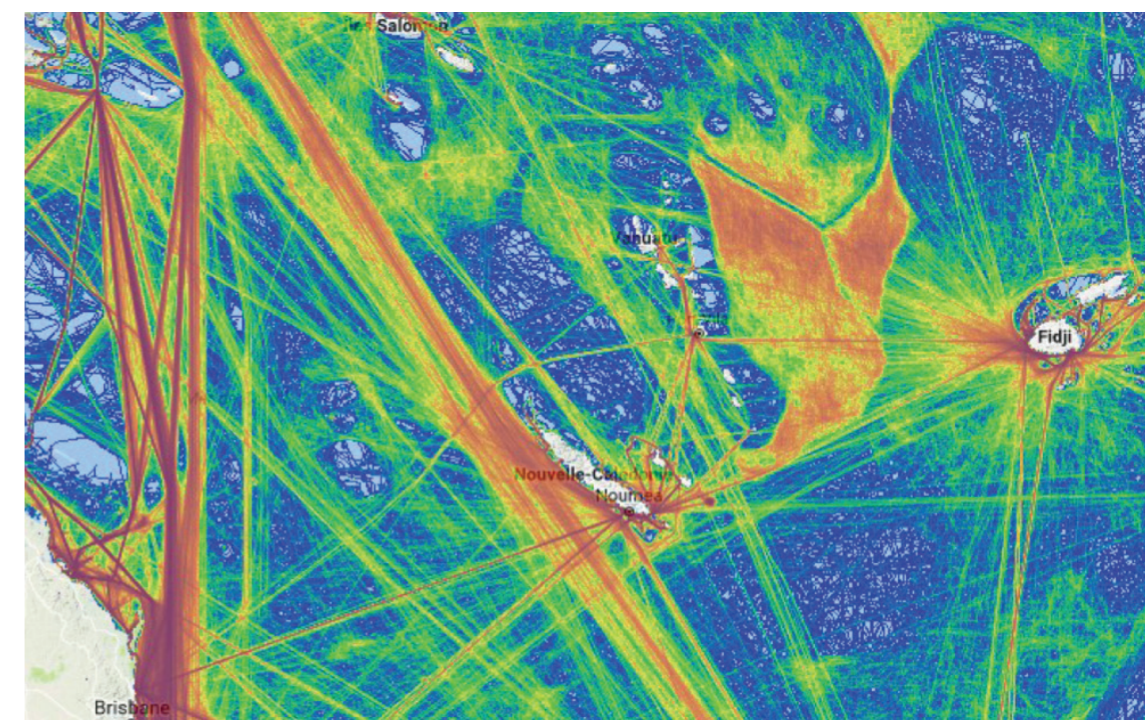

Figure 31: AIS-OPT tracking in 2017 near New Caledonia (source: MRCC 2017).

<sup>17</sup> The Natural Marine Park of Coral Island. Report by the Government of New Caledonia, 2015, 90p.



This very high density of navigation, fishing and marine transit activity (Figure 30) should continue to grow regionally in particular due to the increasing dependence of island countries on imports of food and manufactured goods.

A distinction can be made between several major categories of marine traffic (PACPOL Strategy and Work Plans 2015–2020):

- transit traffic: vessels passing through the region without stopping
- international traffic (separate from transit traffic): vessels based in a major port of the region and coming from or going to a country located outside the Pacific region
- regional traffic: vessels travelling between Pacific region countries or territories
- domestic traffic: vessels travelling within a Pacific region country or territory
- foreign fishing fleet: fishing vessels based in nations outside the Pacific region
- domestic fishing fleet: fishing vessels based in a Pacific region country or territory
- other traffic: vessels with a special mission (e.g., military vessels, research vessels, private yachts or tourist ships other than cruise liners).

The number of cruise liners in the South Pacific region is also increasing rapidly: up 18.7% in 2014 over 2013, and more than doubled since 2010 (source: World Bank 2016). In 2014, cruise liners transported more than 400,000 cruise passengers from the region's two main source markets of Australia and New Zealand (Govan 2017). In New Caledonia, where cruise traffic has become a major business (500 stopovers in 2017 of which 200 in Noumea), the forecast for 2019 and 2020 indicates that these figures will stabilise or even fall slightly in terms of the number of stopovers for economic and structural reasons (capacity for vessels to dock in Noumea and in the Loyalty Islands). In the absence of any appropriate port facilities, cruise liner anchoring within the reef-lagoon areas can also have a significant impact on sensitive benthic habitats (Léopold et al. 2009).

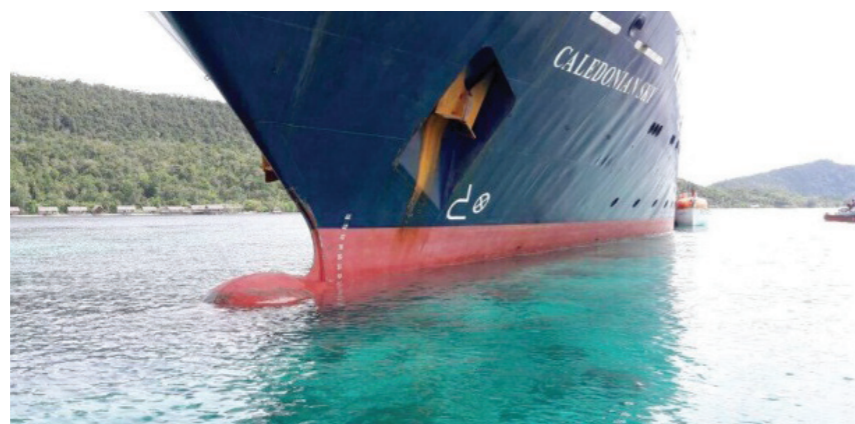

**Figure 32:** *Caledonian Sky* cruise liner moored in a reserve in Indonesia (Raja Ampat, March 2017) and having impacted on more than 18,882 m<sup>2</sup> of coral reefs (source: www.blueocean.net).

Two main organisations operate internationally in the maritime sector:

- The CMI (Comité Maritime International, [www.comitemaritime.org](http://www.comitemaritime.org)) is an international non-governmental organisation whose aim is to contribute to standardising and harmonising the various maritime legislations worldwide
- The IMO (International Maritime Organisation, [www.imo.org](http://www.imo.org)) is an international organisation whose main tasks is to regulate provisions concerning safety at sea.

The IMO has adopted some 40 conventions and protocols, and produced more than 800 collections of rules, codes and recommendations. All these texts deal exclusively with maritime safety, pollution prevention and other associated issues. The organisation also has a procedure for designating particularly vulnerable marine areas subject to protection measures, such as mandatory organisation systems for marine traffic. At present, 14 areas (and two extensions) are protected, including those covering the marine sites inscribed on the UNESCO World Heritage List.

In order to boost maritime safety, the IMO has adopted mandatory regulations concerning the installation of automatic identification systems able to provide information from one vessel to another as well as to coastal authorities. These regulations are part of chapter 5 of the SOLAS<sup>18</sup> (Safety of Life at Sea) Convention. The regulations, adopted by the majority of the world's commercial fleet, concern all passenger liners whatever their size, as well as all vessels with a gross tonnage (GT) of 300 or more tons engaged in international voyages.

The more commonly used surveillance systems for marine traffic include the AIS (Automatic Identification System), which can manage the GPS positions, speed, heading, type and time of vessel arrivals to and from the surrounding vessels (Figure 33). These on-board or land-based systems increase with importance the denser and greater traffic becomes, especially in straits and canals and in dense port areas. This system has advantages for marine transport stakeholders, such as improving safety, improving fleet and navigation management, and the management of fleets and navigation as well as managing maritime routes, the generalised use of AIS also raises confidentiality issues for ship owners, even safety, as the data transmitted by the AIS is available without any restriction.

AIS is often confused with the Long-Range Identification and Tracking System (LRIT) created in 2006 by the IMO. LRIT data transmitted by satellite is not freely available unlike the AIS data. It is only provided on request to administrative authorities authorised to receive this data as well as to search and rescue services.

The AIS and LRIT systems are of crucial interest for safety and maritime security. They provide almost real-time vessel tracking and therefore contribute to the application of national, regional and international policies in all maritime sectors.

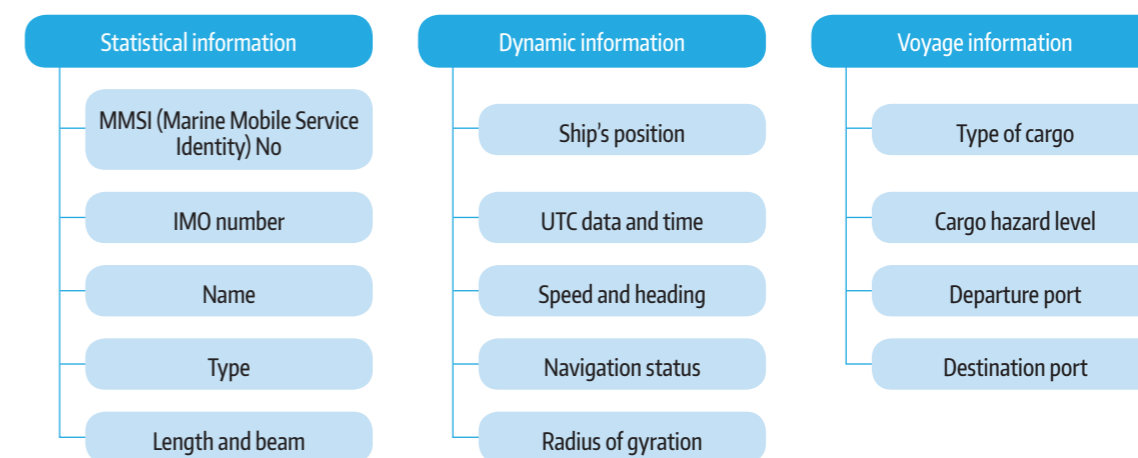

**Figure 33:** Nature of the data potentially collected and transmitted by an AIS (source: after Serry et Lévêques, 2015).

<sup>18</sup> Safety Of Life At Sea [<http://www.imo.org/About/Conventions/ListOfConventions/Pages/International-Convention-for-the-Safety-of-Life-at-Sea-%28SOLAS%29,-1974.aspx>].

### III.4. TOURISM AND RECREATIONAL NAUTICAL ACTIVITIES

Tourism is an essential growth sector for the economies of Pacific island countries and territories. However, a distinction needs to be made between:

- tourists arriving by air who numbered two million passengers and generated income of USD3 billion: Fiji being by far the flagship tourist destination (Figure 34), followed by French Polynesia, Papua-New Guinea, Cook Islands, Samoa et Palau. New Caledonia, with 115,676 air tourists in 2016, accounted for 6% of the region's air tourism
- cruise liner tourists accounted for one million visitors to the region in 2016. The breakdown of this marine tourism is different to that for air traffic with 90% of the tourists concentrated on four destinations: New Caledonia (47%), Vanuatu (24%), Fiji (16%) and French Polynesia (5%) (Figure 35).

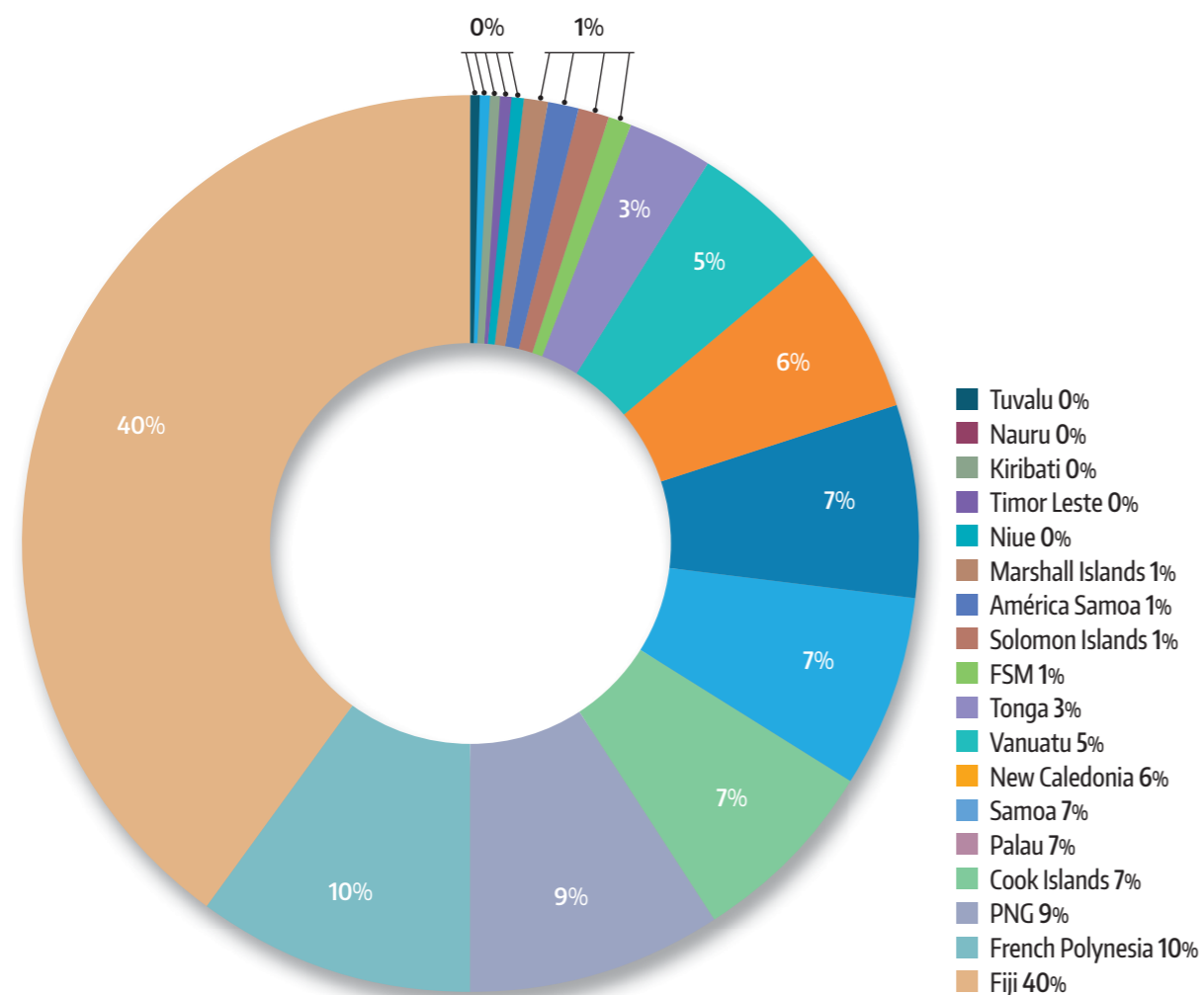

**Figure 34:** Breakdown of tourist arrivals by air in 2016 between 17 Pacific Island countries and territories (source: after South Pacific Tourism Organisation).

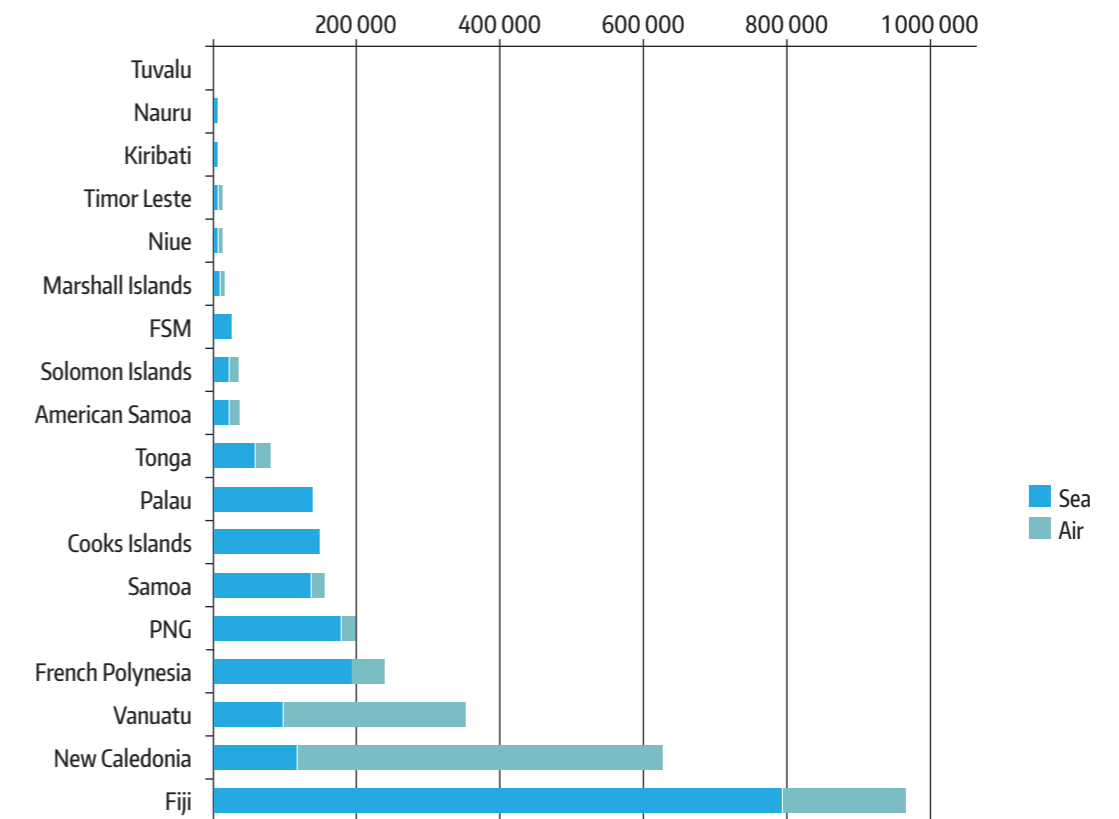

**Figure 35:** Cumulative number of tourists in 2016 for the 17 Pacific Island countries and territories, by transport mode used (source: after South Pacific Tourism Organisation).

Generally speaking, activities focused on the sea exert a high level of attraction for tourists. A study conducted in 2012 in Fiji found that swimming was one of the first reasons for travelling (75% of the tourists surveyed) and that aquatic and beach activities were quoted by 50% of the respondents (Verdone et al. 2012).

Against a backdrop of growing tourism, especially cruise business in recent years, as is the case in New Caledonia (Figure 36, but also for French Polynesia Figure 37), the introduction of sustainable tourism has gradually become a priority. In addition to the problems around mooring these large vessels, the massive influx of tourists and the pressure exerted on the coastal fringe and the natural marine resources are a potential source of environmental impact. Reconciling environmental protection and these growing at tourism activities is a major challenge and will require a significant increase in ecotourism practices.

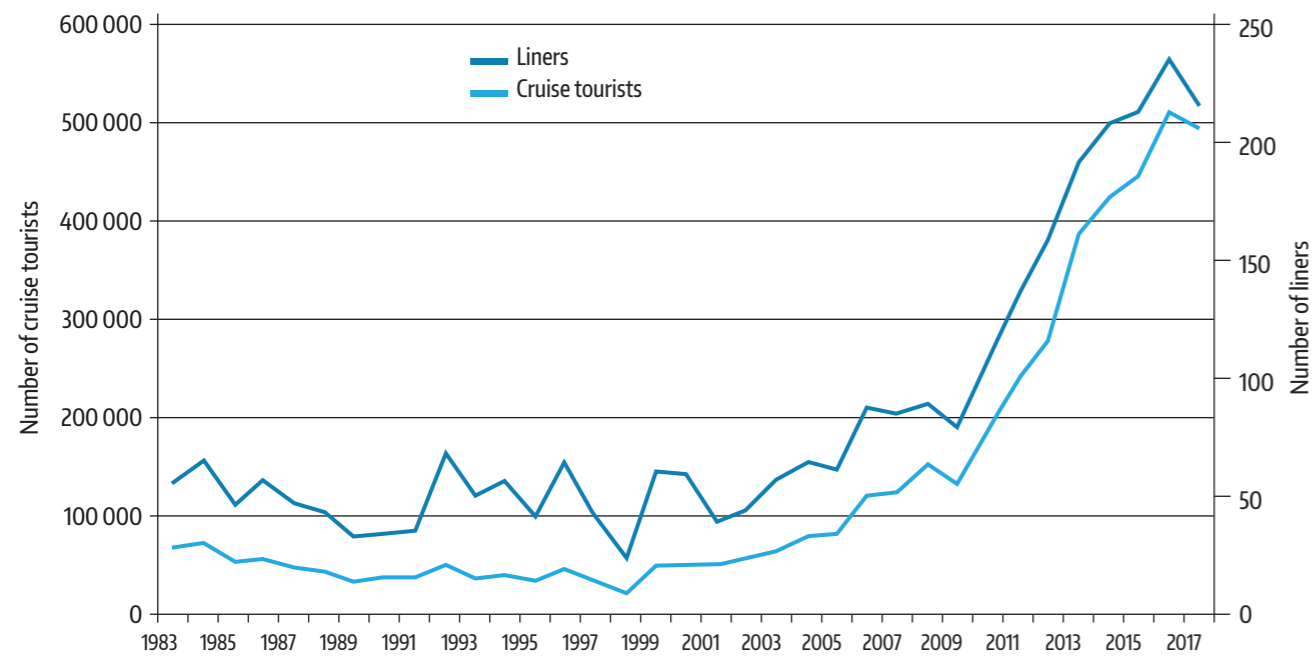

**Figure 36:** Growth in the number of cruise tourists and liners calling in to Noumea, New Caledonia (source: after ISEE).

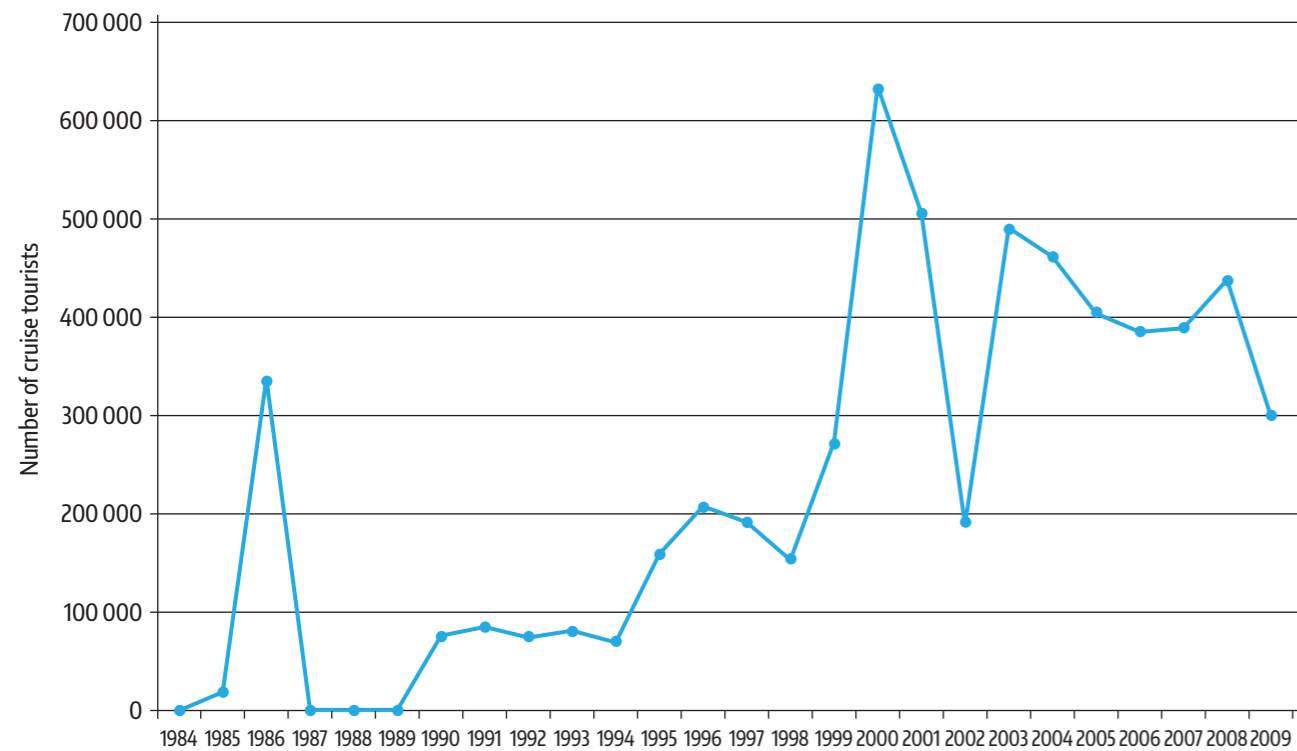
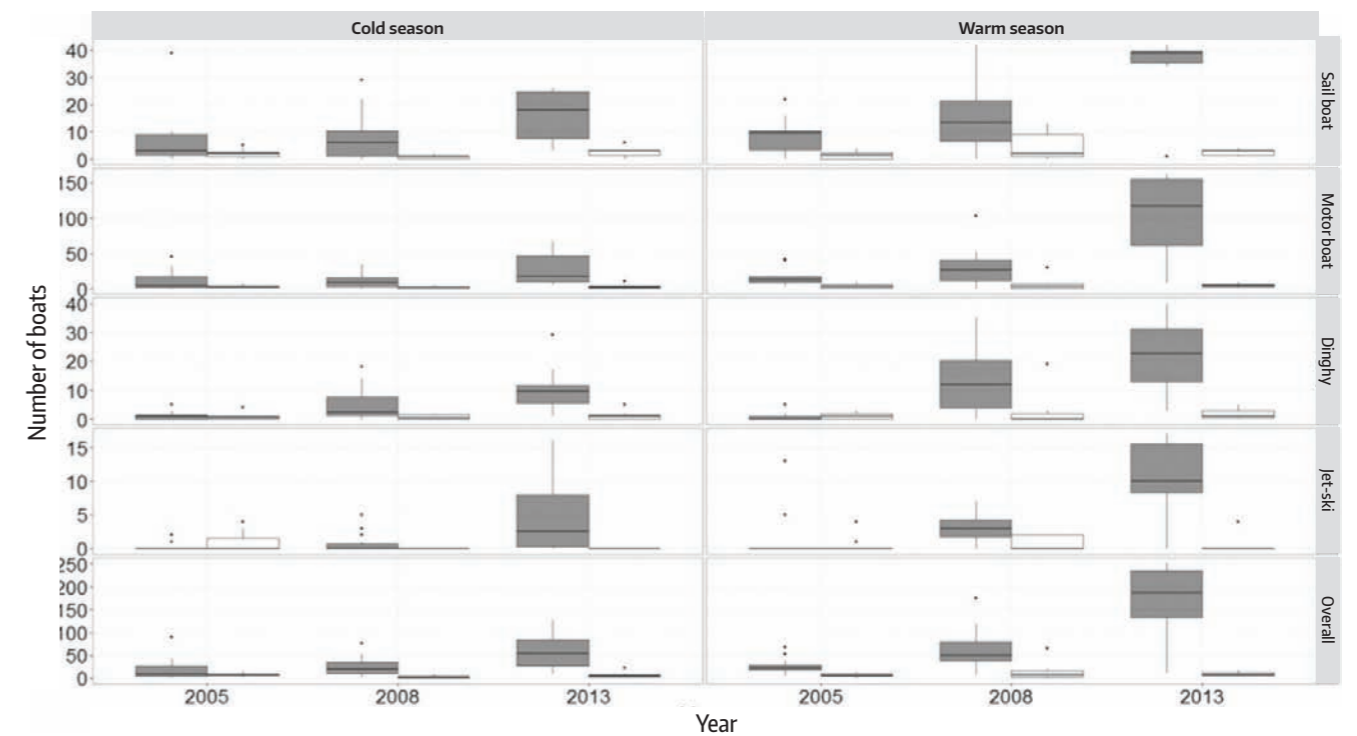

**Figure 37:** Change in the number of cruise tourists between 1984 and 1999 in French Polynesia (source: after Blondy 2011).

This situation also requires the introduction of spatial management in usage areas, particularly those areas with a high ecological value. For example, the current projects decided by the Government of New Caledonia concerning the management of the recently created PNMC, in addition to classifying 100% of the reef areas as natural reserves or strict reserves – i.e., closed to the public unless granted government authorisation – regulations govern all tourist activities in the entire Park (source: Government of New Caledonia):

- mandatory authorisation required to exercise any professional tourism activity
- ban on all ships carrying more than 200 passengers from entering the natural reserves
- organised disembarking by maximum groups of 12 people
- ban on all pets, motorised water sports, fishing, hunting, foils and aerial activities, whether motorised or not
- management for all other activities (number of people authorised, specific zones, etc.)
- mandatory onboard personnel trained in best practices and the regulations
- monitoring activities by an observer onboard ships, satellite tracking of ships and mandatory provision of an annual activity report.

More generally, and with the same consequences of the traffic generated by certain types of tourism, demographic growth, especially along coastal areas, is exerting growing human pressure on the marine environment through all types of recreational (swimming, visiting beaches and islets, locating mooring sites, etc.) and extractive (recreational fishing) activities.



**Figure 38:** Seasonal change in the number of motorised vessels by category between 2005 and 2013 (source: Gonson et al. 2016). Grey: data for number of days. White: data for number of weekends.

In New Caledonia, a recent study (Gonson et al. 2016) showed that over the 2005 to 2013 period, the number of boats increased drastically on the lagoon islets located within direct proximity to Noumea (Figure 38). It highlighted the increase in visits to natural reserves, low use of ecological moorings installed between 2008 and 2013, and the need to increase actions concerning environmental protection in the broad sense of the term.

Monitoring recreational activities and studying their space/time distribution, by qualifying their evolution, provides managers with the means to anticipate potential impacts and to implement appropriate responses. The introduction of monitoring systems for recreational and tourism activities, and more generally the number of visits to coastal marine areas, would appear to be a priority given the increasing number of marine protected areas.

## IV THE MAIN MONITORING ISSUES

As mentioned at the start of this report, an overview of the major monitoring issues for the four targeted OCTs is not the purpose of the present study. Rather, its aim is to place these in their context and provide an introduction to the core of the study, that is, a review of monitoring technologies and the selection tool. Consequently, the summary of monitoring issues presented here is indicative only. Further, as it is the result of several sources of information and discussions, it is in particular based on:

- the contextual elements specific to the four European OCTs, detailed above
- the priorities stated more or less in detail by certain managers in their responses to the questionnaires
- the issues expressed and/or perceived by the authors in meetings with key numerous stakeholders concerned or involved in maritime monitoring (e.g., SPC, SCRRE, AEM-NC, AEM-PF, etc.)
- the expertise and thematic experience of the various project stakeholders (authors of the present document in consultation with the AFB).

This part of the study therefore constitutes a summary discussion combining and aligning these various sources of information in order to provide an overall view of monitoring issues, some of which are discussed in the case studies presented below.

In the context of this summary, the levels of issues have been characterised in a semiquantitative manner (four classes) for seven categories of human activities considered as significant from a monitoring point of view. This categorisation remains basically sectorial so that it can be aligned with the technological solutions presented in parts 2 and 3, for which the selection is highly dependent on the type of activity and objects to be monitored. These categories are also largely present in the majority of the OCTs' maritime areas (Table 12). In this table, the issue values are unrelated between each of the categories of human activities, therefore for a given OCT, the level of issues should not be compared between categories.

**Table 12:** Indicative summary of the issues around monitoring and/or tracking human activities in the OCTs' maritime areas within the regional context.

	Wallis & Futuna	New Caledonia	French Polynesia	Pitcairn
Maritime traffic	1	3	3	1
Cruise traffic	1	3	2	1
Commercial coastal fishing	1	2	3	0
Commercial oceanic fishing	0	2	3	0
Subsistence and non-commercial fishing	2	3	3	2
Illegal activity	2	2	2	3
Other recreational activities	1	3	3	0

0: Nil to low issues    1: Low to average issues    2: Average to high issues    3: High to extreme issues

The level of issue inherent in maritime traffic, especially the risk of pollution, can be addressed in a simplified manner by correlating it directly to the density of traffic observed in the EEZ and its periphery (Figure 39). Thus, the high levels of maritime traffic density in New Caledonia and French Polynesia mean that the issues around monitoring and tracking this activity are high. This finding is consistent with the results of the report produced for SPREP<sup>19</sup> and PACPOL<sup>20</sup> in 2003 and which identified these two OCTs as having a relatively high potential for collisions (Anderson et al. 2003). In New Caledonia where cruise liner traffic is particularly high, a study on the number of visits by liners to the Atolls d'Entrecasteaux Marine Park, coupled with the declared data and satellite optical image analyses, is currently in the finalisation stages at the New Caledonia Maritime Affairs Department, demonstrating the high level of issues around the transit of large ships in sensitive areas.

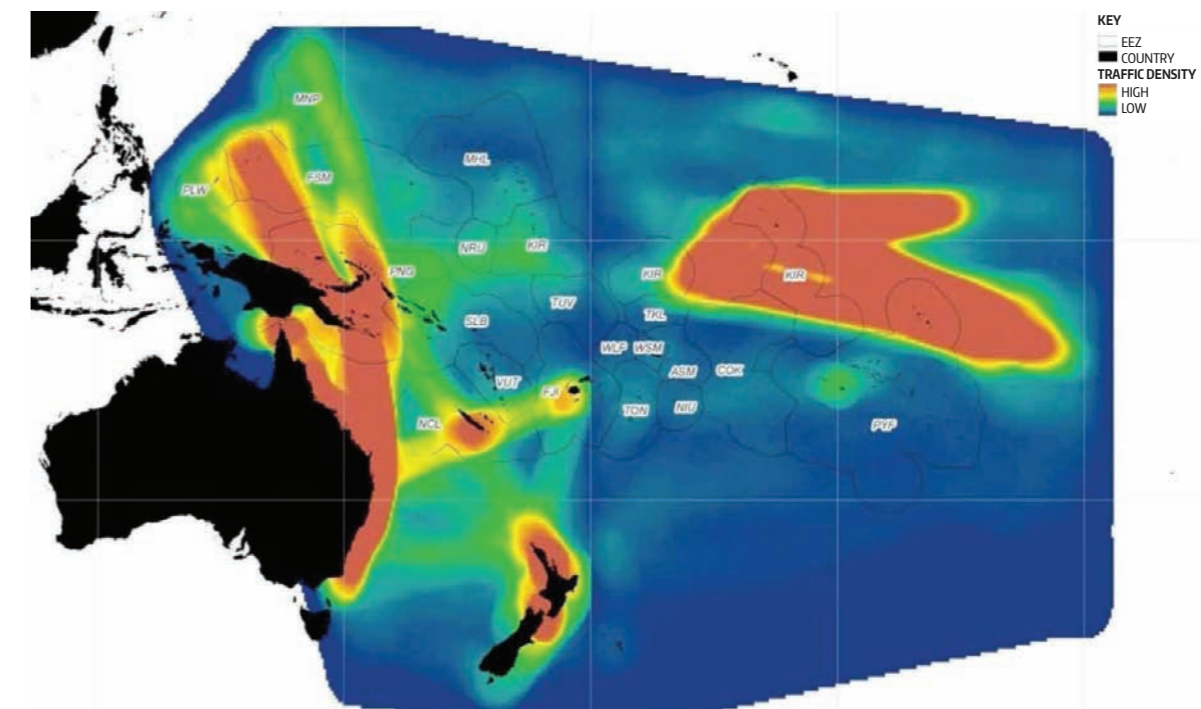

**Figure 39:** Maritime traffic density in the South Pacific region (source: SPREP 2014).

The number of tourist visits (including cruise passengers) is a definite development issue for the four OCTs. However, the associated level of pressure is linked to the level of development and number of tourists, which is relatively small in Wallis & Futuna and Pitcairn. In French Polynesia, with around 31,000 cruise passengers in 2017, the cruise traffic is 15 times less than that reported for New Caledonia, which for the same year had a total of around 493,000 cruise passengers. While the total number of human visits is an issue (cf. recreational activities and uses below), the cruise liner tourism sector, requiring frequent stops and massive tourist influxes at sites without the necessary infrastructure (wharf or appropriate anchoring site) is a major and a growing issue for French Polynesia, but above all for New Caledonia (Figure 36).

<sup>19</sup> South Pacific Regional Environment Program

<sup>20</sup> Pacific Ocean Pollution Prevention Programme

Figures concerning **professional coastal fishing**<sup>21</sup> reveal marked differences in terms of development between the four OCTs. Overall a distinction can be made between Pitcairn and Wallis & Futuna where the fishing sector has largely remained at the subsistence level with production mostly for local consumption. Monitoring these activities, aside from conventional monitoring methods (e.g., fishing log book), is deemed a low-level issue for these two OCTs. Contrariwise, the other two OCTs have more developed professional coastal fisheries, with 424 and 167 fishing licenses issued in French Polynesia and New Caledonia respectively by the fisheries authorities. The issues around implementing monitoring and tracking using specific technology would appear to be more important in these two cases. French Polynesia has committed to a technological development approach to ensure improved control over the use made of fuel aides, with the recent decision to make it mandatory for the entire coastal fishing fleets to equip their boats with an automatic declaration system.

Because of the significant economic issues and regionally shared fisheries stocks, **professional oceanic fishing** in the OCTs, where it exists, comes under both regional and local management requiring the introduction of monitoring and tracking for which the methods have been detailed earlier. This fishing sector is the one that routinely calls on numerous technological solutions. The absence of an oceanic fleet in Wallis & Futuna and the Pitcairn Islands would indicate that, apart from illegal activities considered separately below, the issues around monitoring and/or tracking the activity is not necessary. However, these issues remain important in New Caledonia and very important in French Polynesia, as the latter aims to double its fisheries production within the coming decade. The emergence of technologies suitable for these activities, such as fishing data e-Reporting or e-Monitoring (cf. above) shows that fisheries managers' work on identifying technological support is very real, and that these solutions should be used increasingly widely in the coming years. In this respect, French Polynesia recently launched the rollout of e-Reporting on its entire longline fleet.

**Non-professional fishing** covers a very wide range of informal activities: subsistence fishing, recreational fishing, sports fishing, etc. Despite its socio-economic and cultural importance in the OCTs, and the significant sustainability issue it encompasses, there is currently no quantitative tracking of this activity, especially at a broad geographic scale. This may be due to the complexity of this sector: widely differing fishing practices and techniques, broad variety of resources fished and types of fishers, fishing areas and long-term and sometimes isolated disembarking, various uses for the catch and complex traceability of sea products once offloaded, and even the existence of a broad range of informal marketing channels. Given the very strong links between the population and fishing activities in all of the OCTs, as evidenced by the high level of consumption of seafood (Figure 5), the pressure on fisheries from these nonprofessional activities would seem linked to the ratio between the population and fishable area (mainly reef-lagoon areas). This criterion results in a distinction between Pitcairn and Wallis & Futuna, on the one hand, and New Caledonia and French Polynesia, on the other. Thus, monitoring and tracking nonprofessional fishing activities would seem to be a particularly important issue for New Caledonia and French Polynesia, in particular in those areas where the population is concentrated and so engages in fishing activities.

Monitoring and tracking **illegal activities**, especially fishing, is a significant issue for the region and Pacific island OCTs. This is all the more important in the case of Pitcairn where the EEZ has been classified as a strict nature reserve. The Pacific Islands Forum Fisheries Agency' (FFA) has demonstrated that so-called illegal fishing results in an annual loss of around USD600 million for the region. Note that surveillance issues around illegal fishing activities vary depending on the OCT. Although it concerns the entire EEZ,

they are concentrated on the remote reef-lagoon areas in New Caledonia where the main illegal activities involve fishing sea cucumbers in relatively shallow water (blue boats) or even shark fishing close to reef areas. These local considerations specific to each OCT result in different priorities and monitoring methods. This concerns each of the OCT without exception, and the technological tools are available today to combat illegal, undeclared and unregulated fishing while securing sustainable fishing. The French OCTs alone have acquired complementary State marine and air resources, which improves the system's effectiveness.

With regard to the outlook, New Caledonia, for example, has undertaken a technical study concerning the use of a Wave Glider (unmanned surface vehicle (USV), Figure 19) equipped with key sensors (AIS receiver, acoustic sensor and camera, as already deployed by the Pitcairn Islands) to detect and identify any fishing vessels illegally operating in its EEZ (e.g., *blue boats*). Other activity monitoring systems (in particular given the future classification of natural and/or strict reserves for remote coral reefs) are currently the subject of projects or tests, but the corresponding information has not been provided.

Finally, **recreational activities and uses**, numerous activities practised by the local population and tourists within the maritime space (Figure 40). There are leisure activities (bathing, pleasure craft, etc.) and sports (windsurfing, kite surfing, kayaking, scuba diving, etc.), as well as marine-based tourism activities such as whale watching, snorkelling and even shark feeding. The various forms of occupation of the area and exploitation of the environment by humans create a complex set of interactions that may lead to conflicts between users and result in environmental deterioration. Knowledge of the dynamics of human activities is thus a major monitoring and/or tracking issue for the OCTs. This is particularly true in French Polynesia and New Caledonia, which have equivalent populations (275,918 and 268,767 respectively), positive growth rates, and expanding tourism. On the other hand, Wallis & Futuna and Pitcairn have negative growth rates, small populations (12,197 and 52 respectively) and relatively undeveloped tourism, which therefore means far less significant issues in terms of maritime monitoring for this activity sector.

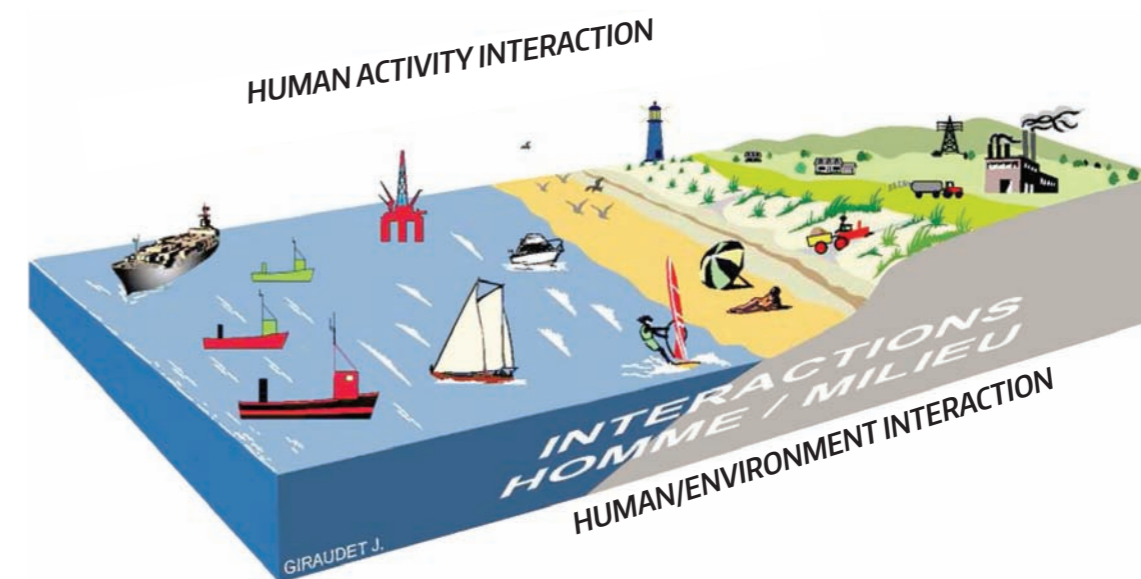

**Figure 40:** Illustration of the interaction between human activities coastal areas (source: Le Tixerant 2004).

<sup>21</sup> This term includes coastal and reef-lagoon fishing for trade.



# PART 2

## REVIEW OF MONITORING TECHNOLOGIES

## I ARCHITECTURE OF MONITORING AND TRACKING TECHNOLOGIES

The monitoring and tracking technologies applicable to the maritime area systematically include three components (Figure 41):

- 1 a measurement device;
- 2 a means to transmit the measurement;
- 3 an Earth segment.

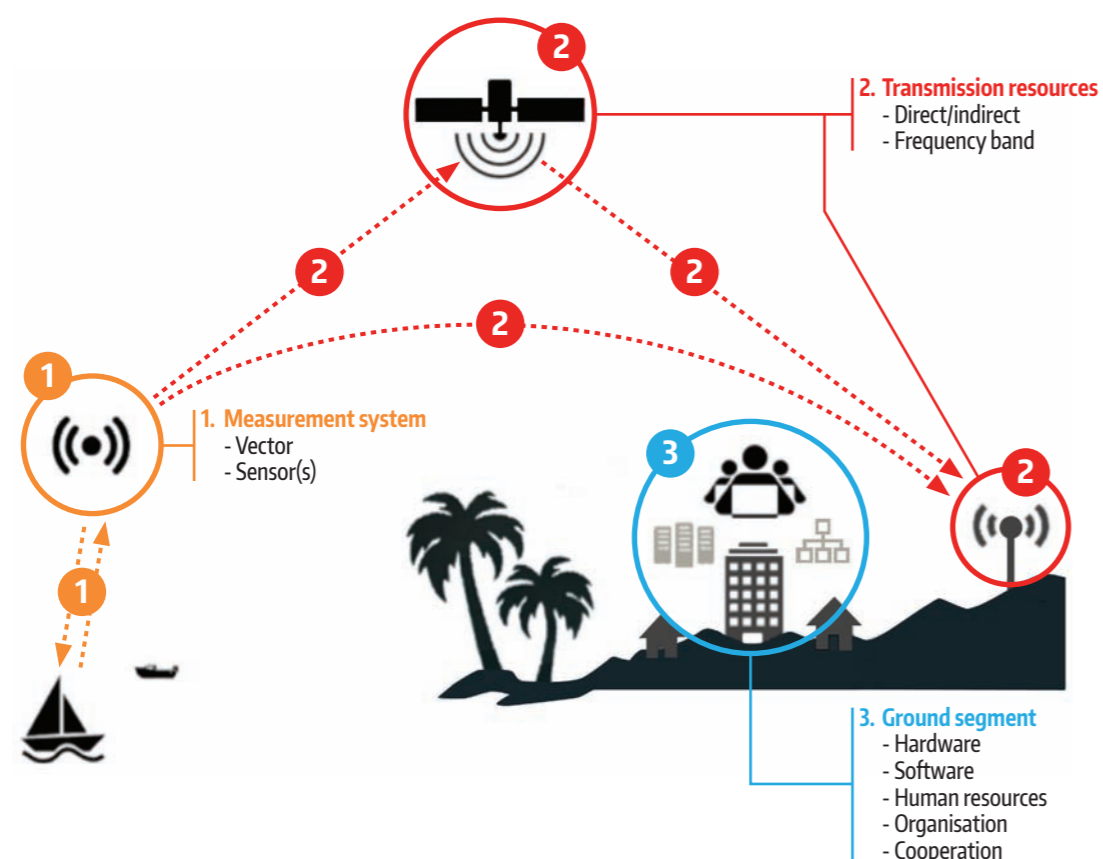

**Figure 41:** Standard architecture for monitoring and tracking technology.

The technical characteristics of each of these components defines the possibilities of the monitoring or tracking applications in terms of their:

- application and precision
- observation frequency
- time lag for access to the measurement information
- technical limitations

### I.1. THE MEASUREMENT DEVICE

**Measurement device = vector + sensor**

The measurement device comprises a vector and one or more sensors.

The vector is the support containing the sensor. This support may be fixed (antenna or mast) or mobile (satellite, drone, aircraft or boat). The vectors used by monitoring technologies in the marine environment are:

- buoys, masts or antennas (especially in port or coastal areas)
- boats
- aircraft (planes and helicopters)
- flying drones or marine (surface or submarine) vehicles
- satellites.

The onboard sensors vary considerably but can be grouped into three major families: identification and location sensors, imaging sensors and physical signal sensors. Although the measurement made by radiometers and imaging radars on satellites, drones or aircraft provides a physical measurement, these measurements are spatialised in order to provide images of the space observed. As a result, these sensors are classified among imaging sensors.



**Figure 42:** Left, a satellite (vector) with an on-board imaging radiometer (sensor) (source: DigitalGlobe); right, high altitude drone (vector) carrying a camera (sensor) (source: Aces Flying High).

**Table 13:** Families of sensors and sensors used for maritime monitoring and tracking.

Identification and location sensors	Imaging sensors	Physical signal sensors
GNSS (Global Navigation Satellite System) antennas	Camera Video camera Imaging radiometer Synthetic aperture radar	Radar Hydrophones Sonar (active/passive)
Data format: Text	Data format: Digital raster grid Image	Data format: Digital table Digital list

The characteristic technical parameters defining their area of application, precision and extent of sensors, are summarised in Table 14.

**Table 14: Technical parameters defining sensors.**

Technical parameters	Description
Type of technology	Cooperative or Non-cooperative
Type of sensor	Description of sensor type
Area of sensor application	Sensor's physical or thematic area of application
Vector	Vector able to carry the sensor
Type of data	Format and complexity of data transmitted
Infrastructure	Infrastructure equipment needed for the sensor's sound operation
Spatial cover	Measurement spatial footprint (one-off to global)
Spatial precision	Precision of measurement spatial position (in metres)
Thematic precision	Measurement precision c/w the theme (Detection, recognition and identification, cf. § 2.2.2.1.)
Spatial resolution	Measurement spatial sampling scale (Very-high, high or average resolution)
Time resolution	Sensor measurement acquisition frequency (The time resolution is dependent on the sensor, sensor spatial cover and type or vector)
Number of operators needed	Indicate the number of people needed to operate the sensor for it to make a measurement (for satellite or AIS sensors, for example, the sensor acquisition is entirely managed by the supplier and requires no field operator).
Technical limitations	Sensor limitation resulting in a significant loss of: <ul style="list-style-type: none"> <li>- measurement thematic precision</li> <li>- measurement spatial precision</li> <li>- measurement time resolution.</li> </ul>
Programmed upgrades	Upgrades are already scheduled or announced by the manufacturers
Innovation potential	Potential innovative applications resulting from the exploitation of the measurements made by the sensor

By way of example, measurement systems include imaging satellites, GPS position transponders, electronic monitoring systems, onboard sonars, etc.

## I.2. TRANSMISSION MODE

The transmission mode corresponds to the technical resources used to transport the sensor's measurement to the onshore operators (Earth segment). The transmission mode may be:

- Manual, that is requiring human intervention (e.g., transfer from a portable storage device, such as a USB key or drone's memory unit, or manually triggering transmission)
- Automatic, the transfer occurs without any human intervention between the sensor and the land-based facilities. In this case, a distinction is made between two modes:
  - Direct transmission modes: the data is transmitted directly to the onshore segment facility
  - Indirect transmission modes: the data is transmitted to the onshore segment facility via one or more repeaters. For indirect transmission, the type repeater may cause limitations due to the technology and/or type of repeater vector used.

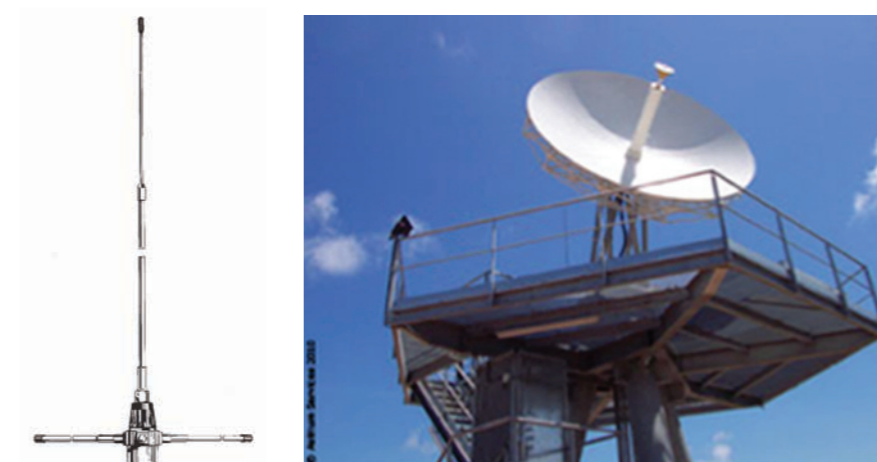

**Figure 43:** Left, VHF receiving antenna for AIS signal (source: Comar SYSTEMS); right, direct receiving station for satellite images (source: Panem et al. 2012\*).

The appearance of Web Services has introduced a new type of data transmission for indirect automatic modes. This type of e-transmission can overcome the need for certain facilities that are initially expensive to install while retaining a high level of service quality and reducing costs.

This transmission mode mainly introduces limitations impacting on:

- the data transmission delay to the Earth segment
- the geographic coverage available for signal transmission
- the quantity and quality of data transmitted.

The characteristic technical parameters to be taken into consideration are summarised in Table 15.

\* Panem CF, Bignalet-Cazalet, Baillarin S (2012) "Pleiades-HR system products performance after in-orbit commissioning phase. ISPRS - International Archives of the Photogrammetry, Remote Sensing and Spatial Information Sciences XXXIX-B1(July): 567-572.



**Table 15:** Technical parameters characterising transmission modes.

Technical parameters	Description
Type of transmission	Manual Direct automatic Indirect automatic
Transmission band	Transmission frequency band Web services This parameter introduces limitations on the quality and integrity of the data transmitted
Transmission delay	Time between the measurement acquisition and its reception by the ground segment
Facilities	Repeater reception antenna Some transmission infrastructure is supplied by the service or must be installed locally
Geographic cover	Reception or repeater antenna cover area. Geographic cover may be global or limited to a visibility cone.
Application complexity	Level of complexity and expertise needed to install and maintain the transmission modes.
Technical limitations	Technical limitations due to the type of transmission, emission domain and geographic cover.

For example, direct satellite receiving stations, Inmarsat satellite telecommunication systems and AIS receiving antennas are among the systems able to transmit sensor measurements to the ground segment.

### I.3. THE GROUND SEGMENT

**Ground segment = Hardware + Software + Human resources + Organisation + Cooperation**

The ground segment corresponds to the infrastructure that uses the measurements made by the sensors. The ground segment includes hardware and software infrastructure and human resources used to extract the information and indicators needed for monitoring and tracking the targeted activities. The ground segment also includes organisational systems, cooperation and a regulatory framework if applicable.

The ground segment is extremely variable in terms of its size and the technical solutions provided: from a simple smartphone with a 4G subscription to an integrated operations centre.

The characteristic technical parameters to be taken into consideration for the ground segment are summarised in the Table 16.



**Figure 44:** Left, ground receiving system for fisheries monitoring using a smartphone (source: Mallalieu and Andrews 2014); right, VMS control centre de contrôle VMS (source: Trackwell VMS).

**Table 16:** Characteristic ground segment technical parameters .

Technical parameters	Description
Hardware	Hardware needed to operate the system
Software	Software needed to operate the system
Application complexity	Number of operations needed and their complexity
Human resources and skills required	Number of operators required and their level of qualifications to operate the system
Data processing	Data processing and analysis to convert the tracking/monitoring measurements
Achievable objectives	Tracking/monitoring targets for the system
Effectiveness	Constraints affecting the tracking or monitoring effectiveness
Structural or regulatory limitations	Constraints due to the organisation or regulations
Cooperation and exchanges	Level of data confidentiality

## II FUNDAMENTAL MEASUREMENT AND OBSERVATION CHARACTERISTICS OF A TRACKING OR MONITORING PROCEDURE

### II.1. DATA PRECISION

When tracking or monitoring human activities at sea, that is, identifying an object in a geographic area, precision refers to two specific aspects: thematic precision and positioning precision.

#### II.1.1. Thematic precision: ability to detect, recognise and identify

Measurement thematic precision corresponds to the fineness of the measurement compared with the stated usage aims. When tracking or monitoring human activities at sea, the aim of the measurements is to identify these activities in a regular and targeted manner to determine action indicators.

Depending on the sensors and activities targeted, the degree of identification obtained from these measurements can vary. A distinction is generally made between:

- detection: the ability to distinguish an object of interest without being able to characterise it (e.g., detection of a ship)
- recognition: the ability to recognise the nature of the object (e.g., a fishing vessel)
- identification: the ability to individualise the object (Igilan - MMSI: 540002100, length 21 m, beam 7 m).

The thematic precision is therefore closely linked to the tracking and/or monitoring aims, the type of measurement as well as the data format and measurement frequency.

#### II.1.2. Position precision

Position precision corresponds to the degree of accuracy in the geographic location of the objects identified. This precision depends on the sensor but also the vector carrying the sensor. For example, a sensor with the ability to provide the geographic position of objects to within a few centimetres: if this sensor is onboard a vector whose geographic position precision is measured in metres, the measurement will only be precise to within a metre.

Position precision must not be confused with spatial precision which corresponds to the size of the smallest object measured. For example, the spatial precision of a satellite image is the resolution in pixels and position precision corresponds to the quality of the image's georeferencing.

### II.2. DATA TEMPORALITY FOR TRACKING AND MONITORING OPERATIONS

The notion of data time is extremely important for tracking and monitoring operations. It depends on the purpose, in particular whether for tracking or monitoring:

- tracking requires regular or continuous measurement or observation to characterise the phenomena
- monitoring requires a type and precision of observations to control regulatory compliance.

Thus, regular or continuous collection technology will be the most appropriate. For monitoring, the technologies must be able to collect the right information at the right moment.

This distinction between tracking and monitoring also introduces a difference in the time to access the usable information (or latency time). Monitoring is used for control and so action. The information must therefore be transported and delivered within a timeframe suitable for operational control needs.

These constraints mean it is necessary to take into consideration the following characteristics to qualify each type of technology:

- the sensor's temporal resolution which defines the measurement acquisition frequency or its ability to measure within the desired timeframe. Temporal resolution depends on the "sensor + vector" pairing and the sensor's geographic cover
- the latency time is determined by the sensor's acquisition frequency, the vector revisit, the geographic cover of the sensor-vector pairing, the transmission mode and the processing needed to convert the measurements into information.

### II.3. MEASUREMENT GEOGRAPHIC FOOTPRINT AND DATA GEOGRAPHIC COVERAGE

The measurement geographic footprint and the data geographic coverage must be separated. The measurement geographic footprint corresponds to the unit measured. For vessel tracking systems, the measurement footprint is a point identified by its geographic coordinates and the margin of error for its location. Depending on the technologies, the geographic coverage of vessel locating systems may be local (port), regional (coastal area) or global (AIS by satellite, VMS, LRIT).

For imaging systems (drones, satellites or aircraft), the measurement geographic footprint corresponds to the image resolution (pixel size); the data geographic cover is determined by the imaging apparatus's swath. These two dimensions are linked as they depend, in addition to the sensor's technical characteristics, on the acquisition altitude. Consequently, the larger the measurement geographic footprint (or resolution), the smaller the data geographic cover.

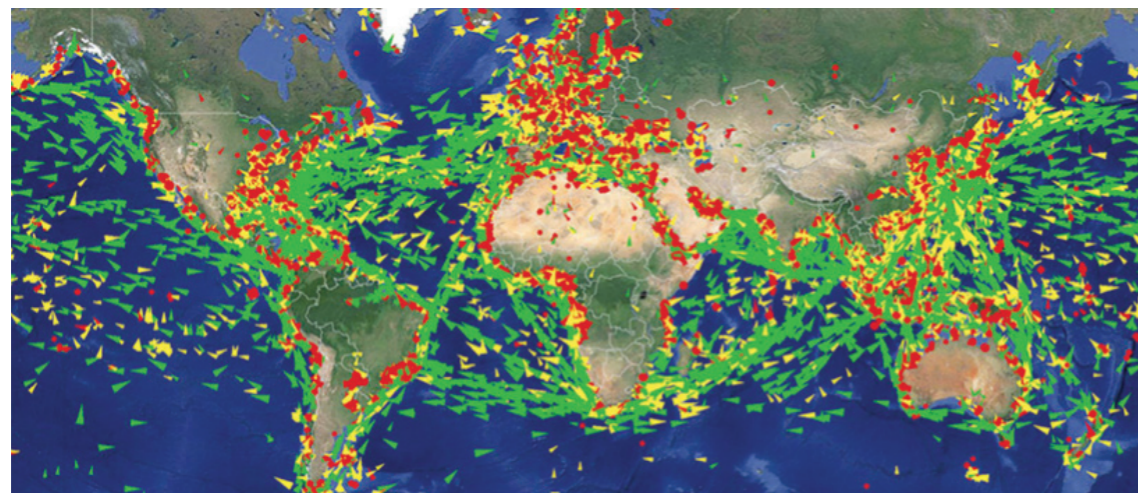

**Figure 45:** Point data with global geographic cover; example of AIS by satellite (source: SpaceNews Magazine).

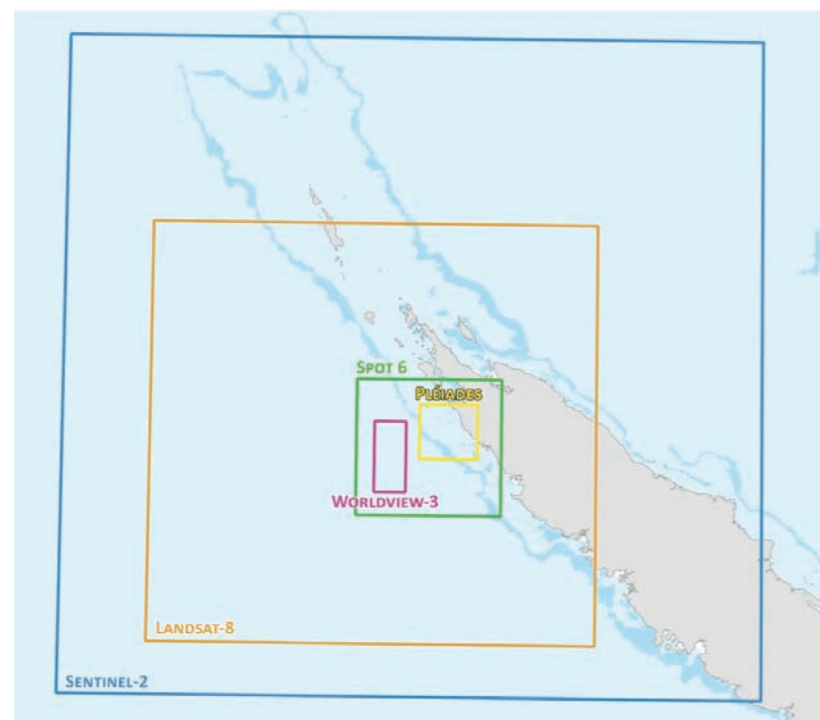

**Figure 46:** Examples of various geographic coverages of satellite images (source: BLUECHAM SAS).

### III SHIP POSITION TRACKING/MONITORING TECHNOLOGIES

These technologies are used to identify and track the position of vessels with a high time frequency. They are cooperative technologies as the measurement instruments are installed on the vessels voluntarily or by mandatory regulation.

#### III.1. GENERAL PRINCIPLE

These technologies operate on the basis of the following general principle:

- the vessel transmits its location and identification at regular intervals
- the information is transformed in the form of secure text by satellite or radio
- the ground segment receives and registers the information in the form of a dot on a map background.

These technologies require:

- a GNSS (Global Navigation Satellite System) receiver, type GPS, GLONASS, Galileo, BeiDou, etc., connected to a transponder onboard the vessel
- the transponder transmits via the allocation of telecommunications satellite resources, type Inmarsat, Iridium, Argos, ORBCOMM, or by VHF radio
- a ground segment to receive the measurements including text signal decoding tools and dynamic geographic position tools for each vessel and their update.

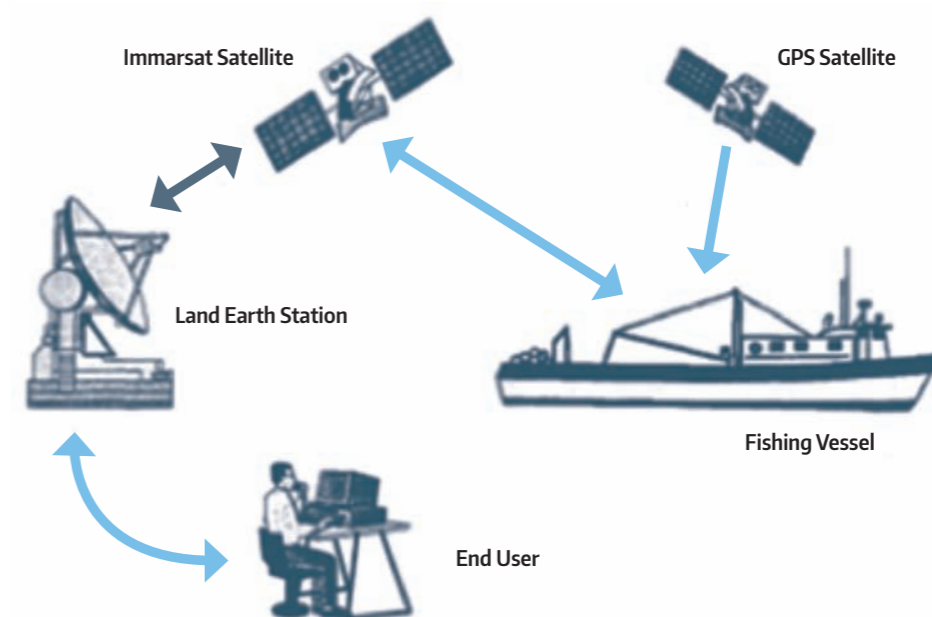

**Figure 47:** General principle of the technologies for tracking vessel positions (source: Seawatch).

There are numerous operational systems of this type: VMS, LRIT and AIS. The differences between them are:

- technological: the transmission is made via satellite in the UHF or SHF bands, by VHF radio for AIS (land and satellite);
- organisational: the type of organisation, regulations and regional integration of the ground segment.

The first difference is therefore technological and differentiates between the technologies based on the transmission of messages by communication satellites (UHF, SHF) and AIS technology that transmits via VHF. This difference leads to constraints around the quantity and quality of the information transmitted. The UHF and SHF frequency bands can carry a greater quantity of data and are secure in order to guarantee the integrity of the data transmitted. The VHF frequency bands, used for telephones, television and messaging, are far more sensitive to interference and mixing with other signals because of the saturation of this frequency band.

The ground segment organisation mode generally distinguishes between the VMS and LRIT systems. These two systems can combine satellite communication and AIS positioning technologies.

The ground segment organisation mode results in the following constraints:

- linked to the regulatory data to be transmitted by vessels and their level of precision requiring certain GPS-transponder equipment
- the structure of the ground segment's hardware/software and its human resources to manage the data supplied
- concerning the regional and international cooperation for the exchange of information.

### III.2. VMS SYSTEMS

VMS (Vessel Monitoring System) are tracking and monitoring systems for locating commercial fishing vessels in order to manage and control this activity, and prevent illegal fishing. Today, VMS systems are technological, involve standardised cooperation by national fisheries authorities and are shared within a regional centre.

VMS equipment varies depending on the recommendations of national regulations. For French territories, the VMS system is regulated by the *Centre de Surveillance des pêches du CROSS* in Etel (France). It is governed by the *European Commission Regulation (EC) No 2244/2003 of 18 December 2003 laying down detailed provisions regarding satellite-based Vessel Monitoring Systems*:

- all professional fishing vessels exceeding 15 metres length overall, should be equipped
- fishing vessels used exclusively for aquaculture and operating exclusively inside the Member States' baselines
- the location systems onboard vessels shall provide:
  - automatic transmission by telecommunications satellite (Emsat, Iridium, Inmarsat, Argos, EutelTracs) of the fishing vessel's identification
  - its geographic position with a margin of error under 500 metres and a confidence interval of 99%
  - the UTC date and time of the fixing of the position
  - the speed and course of the vessel
  - the transmission is made once an hour, however the transmission of this information may be requested at a higher frequency

- fishing vessels may not turn off their VMS while fishing
- the Member States shall adopt the appropriate measures to ensure that the satellite-tracking devices do not permit the input or output of false positions and are not capable of being manually over-ridden. Thus, the positioning system provided by Argos is a non-falsifiable automatic positioning system unlike GPS.

The master of a fishing vessel shall ensure that the satellite-tracking devices are fully operational at all times.

In the South Pacific, the FFA (Pacific Islands Forum Fisheries Agency) regulates the specifications for the VMS system used by 17 countries in the region (Australia, Cook Islands, Federated States of Micronesia, Fiji, Kiribati, Marshall Islands, Nauru, New Zealand, Niue, Palau, Papua-New Guinea, Samoa, Solomon Islands, Tokelau, Tonga, Tuvalu and Vanuatu). The FFA provides a list of approved and authorised VMS units<sup>22</sup>. The FFA only authorises transponders of the E-MTU (Enhanced Mobile Transceiver Unit) type as they can also provide information about the fishing vessel's activity and report the catches, according to a four-hour transmission frequency. ("Type Approval of Units Used with VMS and Authorised Installers | Pacific Islands Forum Fisheries Agency (FFA)" 2018).

From a functional point of view, the ship's VMS transmits, at precise and regular moment, its location as well as all the other information required by the country which issued the fishing license. This information is sent by telecommunications satellite to the national fisheries' tracking centre (ground segment) of the flag ship State. Today, Iridium telecommunications are the most frequently used because they allow for a greater quantity of information to be transmitted at higher frequency compared with the Argos-type systems.

The fisheries national tracking centre of the flag ship state automatically forwards the message to the national fisheries' tracking centre of the country or regional authority which administers the area in which the vessel is located. (Suhendar 2013; European Commission and JRC 2008).

On the ground, the hardware and software include geographic vessel tracking tools showing at least their position and their identification numbers. Depending on the regulations, the hardware and software varies in order to produce all the information required and ensure the information can be exchanged between land Earth stations (Selbe 2014).

Thus, the cost of the VMS system includes the cost of the transponder, allocation of the transmission bandwidth from satellite communication and ground infrastructure operators. The costs rises the greater the degree of precision and complexity of the information to be provided (Kelleher 2002). In 2016, the FFA estimated the cost of a VMS system for a fleet of 1,227 registered vessels at USD1,150,000. The cost of the GNSS receiver and onboard transponder varies between USD1,700 and USD2,300 for the equipment approved by the FFA (Banks, Muldoon, and Fernandes 2016; Graham, Peter 2016). In the USA, VMS equipment costs around USD4,000 plus the satellite communication costs (around USD500, Selbe 2014).

VMS data is exchanged at a regional level (FFA). As it concerns a strategic sector of activity with high added value, fisheries services tend to keep this information confidential (European Commission and JRC 2008; Fournier 2012).

CLS is currently developing a low-cost miniaturised ARGOS beacon solution for traditional, and artisanal fishing boats. This solution should be operational in 2022.

<sup>22</sup> [http://ffa.int/system/files/REG17\\_Type%20Approved%20MTU%20List%202017-a\\_0.pdf](http://ffa.int/system/files/REG17_Type%20Approved%20MTU%20List%202017-a_0.pdf)

### III.3. LRIT

LRIT (Long Range Identification and Tracking) is a messaging system for sea safety and rescue. Technologically, the system requires the same technologies as the VMS system but differs from the latter in terms of its application and its specific regulations set out in Amendment 19-1 of Chapter V International Convention for the Safety of Life at Sea (SOLAS), 1974; Organisation Maritime Internationale 2013:

- LRIT is mandatory for:
  - all passenger ships, including high-speed passenger vessels
  - all cargo vessels, including high-speed vessels, with a gross tonnage of 300 tons or more
  - all mobile offshore drilling units
- these vessels automatically transmit their identification, position (latitude and longitude) and date and time at which the position is provided
- the equipment used must comply with the performance regulations and standards adopted by the International Maritime Organisation
- the message is sent every six hours but this frequency can be increased at the LRIT centre's request
- the message is sent intentionally by the ship's crew.

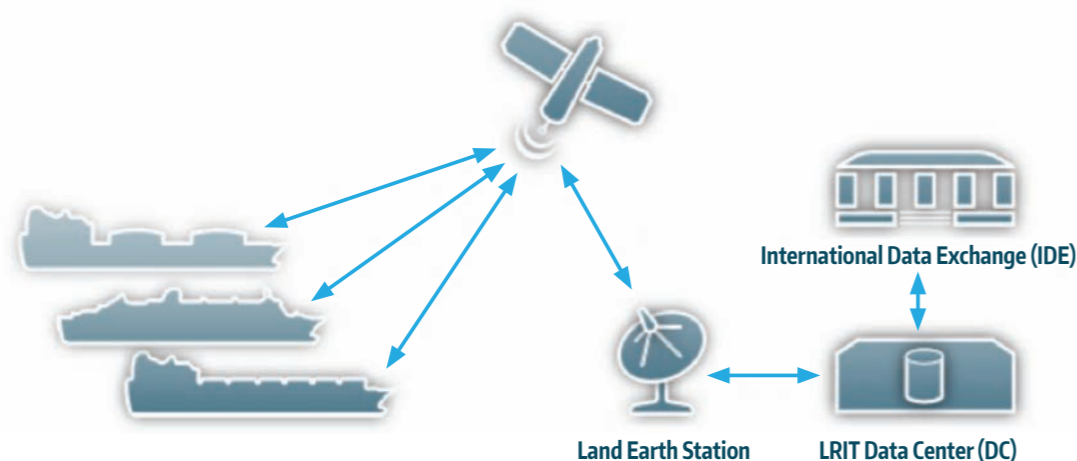

**Figure 48: Organisation of the LRIT system** (source: Pole Star).

The LRIT system is also a complete cooperative navigation tracking tool for certain vessels including: GNSS equipment, vessel satellite communication equipment type GMDSS via Inmarsat, a designated service provider, an LRIT national centre and an LRIT international data exchange centre (LRIT IDE).

The LRIT national centre identifies and tracks the vessel under its flag worldwide and forwards this information to the LRIT IDE centre. The LRIT IDE centre is a central module of the LRIT network interconnecting all national LRIT centres. The latter also enables authorised LRIT network users to request and receive reports on vessels' positions.

In the LRIT network, the data collected is owned by the ship's flag state and all the LRIT network information is confidential. LRIT data is cyphered and only transmitted via the LRIT network to ensure its confidentiality.

### III.4. AIS

AIS (Automatic Identification System) was originally designed as a navigational aid and to allow ships to be seen and see other ships in their area. AIS includes a GNSS receiver coupled with a VHF transponder and receives AIS messages from nearby ships in a visibility cone of around 40 nautical miles. In coastal areas, a VHF antenna can also be used to receive and transmit AIS messages within a visibility cone of 40 nautical miles (Ball 2013; Fournier 2012; European Commission and JRC 2008).

Thus, AIS is a type of technology and not a specific and regulated organisation, like VMS and LRIT (Chen 2014).

In the first decade of the 21st century, ORBCOMM, ExactEarth and Luxspace launched the first satellites able to receive and retransmit AIS messages, thereby making it possible to pick up AIS messages in the open sea. Today, ORBCOMM has a constellation of 18 satellites and 16 land Earth stations providing global coverage for AIS. ExactEarth also has 18 satellites to cover the globe's surface and has created a partnership with Iridium to equip new satellites with an AIS repeater (ORBCOMM 2010; ExactEarth 2014). In this case, the term S-AIS (Satellite-AIS) is used.

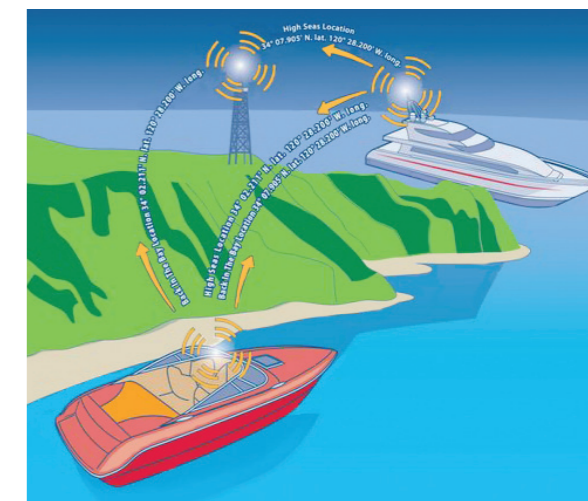

**Figure 49: Initial principle of AIS** (source: United States Coast Guard Boating Safety).

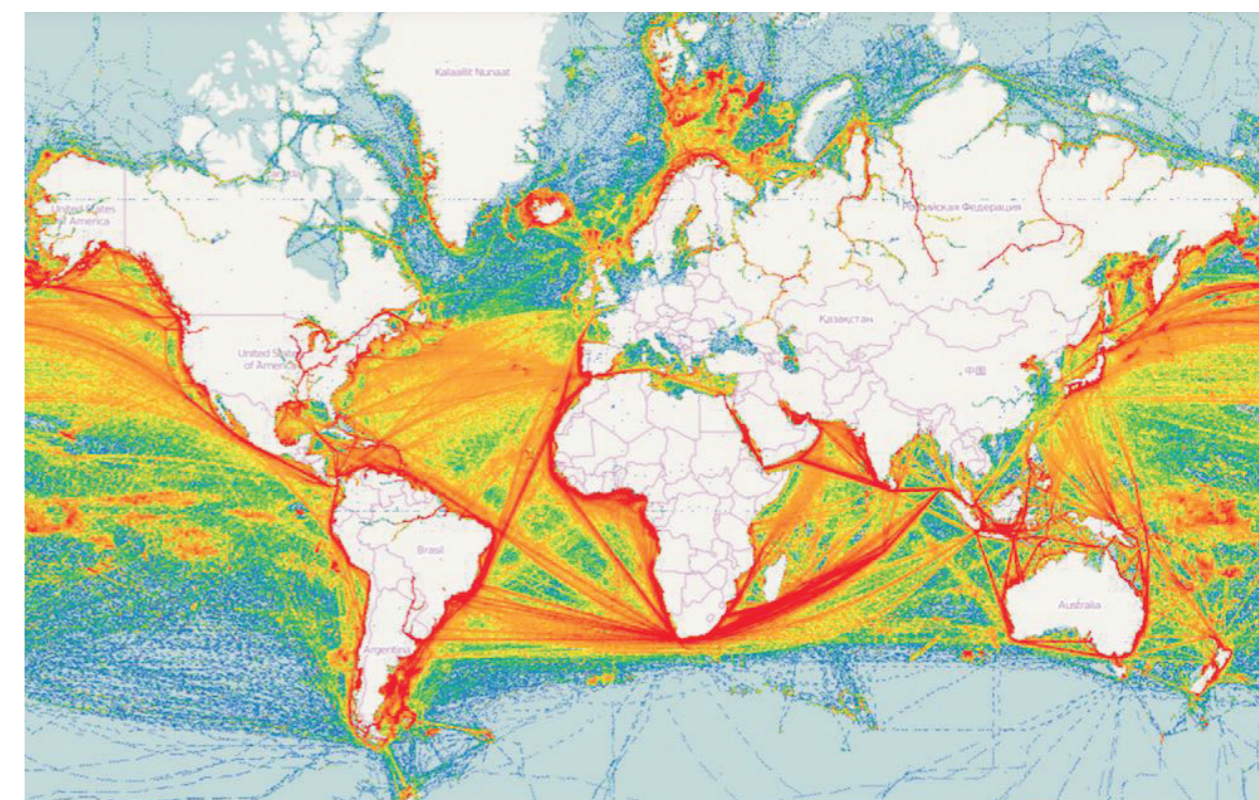

**Figure 50: Map showing the density of AIS and S-AIS signals in 2016** (source: OpenWeatherMap).

AIS sends a text message at regular intervals for which the transmission interval depends on the vessel's speed and heading (from several minutes when moored to several seconds when changing course).

The information transmitted includes the vessel's Maritime Mobile Service Identity (MMSI), geographic position, speed and direction. The user may also provide additional information: departure and arrival ports, type of vessel and its dimensions (<https://www.navcen.uscg.gov/?pageName=AIMessages>). The information transmission delay varies depending on the AIS receiver mode: reception is instant for a land VHF antenna; by satellite, the delay can vary between several minutes and six hours.

However, AIS has several limitations (Chen 2014; Robards et al. 2016; Dujardin 2004):

#### ■ technological:

- the technology is vulnerable to interference as the technical characteristics are public (Dujardin, 2004);
- in dense traffic areas and because it transmits in the VHF band, S-AIS is not always able to separate neighbouring and concomitant signals, and is experiencing early saturation in high traffic areas
- the transmission effectiveness cannot be verified, so message reception is unpredictable (resulting in random missing data)
- managed by a mini-computer, AIS is vulnerable to computer viruses

#### ■ regulatory:

- according to chapter V of the SOLAS convention, AIS is mandatory for:
  - cargos with a gross tonnage of 500 tons or more
  - all vessels in transit with a gross tonnage of 300 tons or more
  - all passenger vessels whatever their size
  - tankers in international transit
- for fishing vessels, traditional vessels and pleasure craft less than 40 metres and vessels less than 5,000 gt, AIS equipment is voluntary
- the information provided by the AIS system is first recorded by the AIS user, who may provide incorrect information.

The use of the VHF band can cut the cost of AIS components, both the vessel's onboard transponder and the transmission of information via free frequency band. Thus the cost of transponders varies between €1,000 or more (Selbe 2014) and the cost of VHF AIS receiver antenna is around €2,000.

With the development of S-AIS, the main suppliers (ExactEarth and ORBCOMM) now provide their data directly via standard web services – tables are automatically received in text format – or via geographic web services that display AIS data directly on a map background. In this case, access to the S-AIS data is offered by the main provider or third-party providers in the form of monthly or annual subscriptions from USD25. The price varies depending on the geographic cover, data precision, quantity of data consumed and the data access delay (deferred or real-time).

AIS data is now widely shared and is also a source of historic data about ships' transit and their behaviour (ship tracks). This historic database and the open access to the data have led to the development of analytical methods based on deep learning to determine the signatures of vessel behaviour. The automated analysis of AIS tracks can also be used to identify suspicious targets on which to focus monitoring or tracking using other means (air reconnaissance or imaging).

## IV IMAGING SYSTEMS

We have included under imaging systems all technologies used to enter image format data. The sensors are varied (camera, video camera, imaging radiometer, synthetic aperture radar) and can be transported by a variety of vectors (ships, flying drones, unmanned surface and sub-marine vessels and satellites). A distinction can be made between two groups of technologies:

- technologies used to capture images or videos used for visual interpretation by a human operator. These technologies use still or video cameras to capture visual proof of the activities targeted. EMS (Electronic Monitoring System) or photographs taken for identification purposes (oblique by aircraft, or surface by unmanned surface vehicle) are included in this category
- technologies used to acquire broad coverage images (photographs or imaging) providing a synoptic view of a given geographic area at a given time (aerial or drone photograph, or satellite imaging). These technologies involve the use of more or less automated processing methods to prepare and analyse the content of this data.

### IV.1. IMAGES AND VIDEOS FOR VISUAL INTERPRETATION

The sensors used are conventional cameras or video monitoring systems. A distinction can be made between two categories depending on the support vector carrying the sensor:

- onboard aircraft or flying drones (aerial monitoring)
- onboard unmanned surface vehicles (surface monitoring).

EMS (Electronic Monitoring System) is a specific case involving video sensors installed directly on ships.

#### IV.1.1. Aerial monitoring

This section deals with conventional aerial monitoring that can be operated by an operator onboard a surveillance aircraft or using drones. This monitoring involves observing and collecting proof (photos and film) of the targeted activities. Aerial monitoring has a wide range of applications for monitoring and tracking human activities at sea, as it can be used to assess the number of people present in a group (e.g., islet or nautical event) through to illegal activity searches.

Consequently, there are a variety of technological options:

- from tourist to military aircraft
- from the professional to military drone.



**Figure 51:** Top, Gardian used by New Caledonia's AEM (*Action de l'Etat en Mer*) (source: Marine française); bottom left, professional civilian drone; bottom right, military drone (source: Smith 2016\*).

The data collected is photographed or videos geolocated. These aircraft are also often equipped with a radar system to detect the targets. This data can be interpreted visually by humans to extract the information: counts, vessel identification, type of activity observed.

The geographic monitoring coverage is limited by the flight autonomy of the vector used. For example, a Gardian has a range of action of 1,800 nautical miles while a Cessna 172 has a range 690 nautical miles (Selbe 2014).

Civilian professional drones have an autonomy varying between less than one hour to two and a half hours (the record is held by a Russian drone at over three hours; the distances covered are also dependent on the type of flight ranging between flying within sight (i.e., the operator must not lose sight of the drone) and distances of over 100 km. Also, many drones are sensitive to water (tightness and sensors) and cannot be used over large bodies of water without risk (Aerosonde and AAI Textron Systems 2014; Bryson and Williams 2015; Smith 2016).

Finally, long-endurance, mid-altitude or stratospheric drones (often military) can fly for tens of hours and cover several thousand kilometres (Ilčev 2018). The record of over 336 hours' flight is held by the Qinetiq Zephyr, a prototype light ( $\approx 10$ kg) solar powered drone developed by Airbus.

The cost of this type of monitoring varies depending on the vector:

- in 2016, the FFA quoted the hourly cost for monitoring missions in an aircraft of between USD700 (Cessna) to more than USD30,000 for a military aircraft (Banks, Muldoon, and Fernandes 2016; Graham, Peter 2016; Lawery et al. 2016)
- a Cessna 172 costs around USD30,000 whereas conventional monitoring aircraft cost around USD100,000 or more (Selbe 2014)
- civilian professional drones cost from USD2,000 to over USD10,000 (including the camera and ground station) to which must be added the monitoring operations (1 to 2 people needed for a flight) and information post-processing (Smith 2016; de Miguel Molina and Segarra Oña 2018).

\* Smith P (2016) A Survey of Advances in MCS & Related Applications of UAS, presented at the MCS Emerging Technologies Workshop, Auckland, New Zealand.

### IV.1.2. Surface monitoring

Patrol boats are typically used for surface monitoring. This type of monitoring typically involves a boat and a crew on patrol. This well-known system will not be covered in this technological review.

Still or video cameras can be installed on unmanned surface vehicles (USV). However, USVs are generally designed for sensors to measure physical parameters (sonar, acoustic sensors or radar). The physical sensor detects suspicious targets; the still or video camera is then used to identify the target (Liquid Robotics 2018; Liquid Robotics 2017a; Liquid Robotics 2017b).

The USV can send the photographs or videos via satellite telecommunication when the bandwidth allows.

USVs are detailed in § Part 2.V concerning physical sensors.



**Figure 52:** Video of a vessel taken by the camera on a *Wave Glider* after acoustic detection (© Liquid Robotics).

### IV.1.3. EMS (Electronic Monitoring System)

EMS systems involve installing a monitoring camera onboard vessels to control activity (fishing in particular) during navigation. The data collected is limited to the vessel and immediate surrounding.



**Figure 53:** EMS system aboard a fishing vessel (© Traceall Global).

The camera system is generally coupled to the vessel's positioning system (VMS, AIS, etc.) to link the activity to a location. The systems are upgradable and can also be coupled to logbooks or be triggered under certain conditions (movement, proximity, etc.) (Bartholomew et al. 2018; Batty 2014; McElderry 2016; Hosken et al. 2014).

The data transmitted is limited by the volume of data generated by the device. Classically, the data is downloaded from the system when the vessel docks in port. Innovations are being tested so that the data can be transferred automatically via WiFi or 3G network to the ground segment (Middleton and Systems 2016). Currently, telecommunication satellite video transmission is not profitable (Banks, Muldoon, and Fernandes 2016).

The data collected consists in hours of video of the activity aboard the vessel. This data is usually reviewed by operators to extract the desired information, such as catch counts (Munro 2016). This step is long and costly. During trials by the FFA, the videos of three months of fishing took one month to analyse (Banks, Muldoon, and Fernandes 2016).

Innovations are being put forward to apply image processing procedures so that the information can be extracted automatically. This kind of software can track fishing by extracting, individualising and identifying between 80 and 95% of the fish caught (Hwang 2016).

In 2016, the FFA estimated the total cost of this EMS system at USD4 million, that is, around USD3,800 per vessel equipped. In British Columbia (Canada), the cost of the EMS system is estimated at USD 150 per day at sea, this is around USD10,000 per boat (Selbe 2014).

## IV.2. GEOGRAPHIC IMAGING

This imaging involves creating an image of the surface of the earth using various physical phenomena, such as the reflection of the sun's energy on the Earth's surface and radar backscatter. Unlike photography, the images contain physical measurements so they can be automatically or semi-automatically digitally processed to extract the information sought.

The sensors used are generally:

- imaging radiometers converting the energy received into a digitalised electric signal, such as satellite optical sensors
- Synthetic Aperture Radar (SAR) or Side-Looking Airborne Radar (SLAR) which record the backscatter of the signal that the sensor sends to the ground surface in the UHF and SHF microwave frequencies (X to P bands).



**Figure 54:** Left, imagery generated by an imaging radiometer; right, imagery generated by synthetic aperture radar (© ESA 2017).

## IV.2.1. The types of imaging sensors

### IV.2.1.1. Imaging radiometers

Imaging radiometers use the sun's light and record the energy reflected by objects on the Earth's surface and convert it into a digital value of reflectance. They are passive sensors that operate during the day (Baghdadi and Zribi 2016a).

The main characteristics of these sensors are:

- the number of spectral bands recorded corresponds to the sensor's sensitivity bands (e.g., blue band, red band, infrared band, etc.). Four-band radiometers including near infrared are termed multi-spectral; sensors with between 4 and 32 bands including near infrared are called superspectral sensors; sensors with over 32 bands are called hyperspectral
- the radiometric resolution defines the sensors' ability to distinguish and separate the various spectral bands (separation of blue, green and red into different and distinct bands).

The higher the number of bands, the finer the radiometric resolution, and the greater the capacity the images will have for recognition by mathematical processing:

- multispectral sensors can distinguish between water and mineral objects on its surface
- superspectral and hyperspectral sensors can recognise the type of material of objects on the water's surface.

The images produced are often confused with photographs as the simultaneous visualisation of the blue, red and green bands (called false natural colours) gives the illusion of a photograph.

The vectors used are mainly aircraft, drones or satellites. The type of vector used affects:

- the geographic coverage imaged which depends on the vector's altitude and travel
- the spatial resolution of the images which depends on the sensor and the vector's altitude (for a given sensor, the higher the vector's altitude, the smaller the image spatial resolution)
- vector revisit and so observation frequency and regularity.

Generally, the higher a sensor's resolution, the smaller the size of data's geographic coverage.

As well as radiometric resolution, spatial resolution can be used to define the level of identification achieved by the sensor-vector pairing (Figure 55).

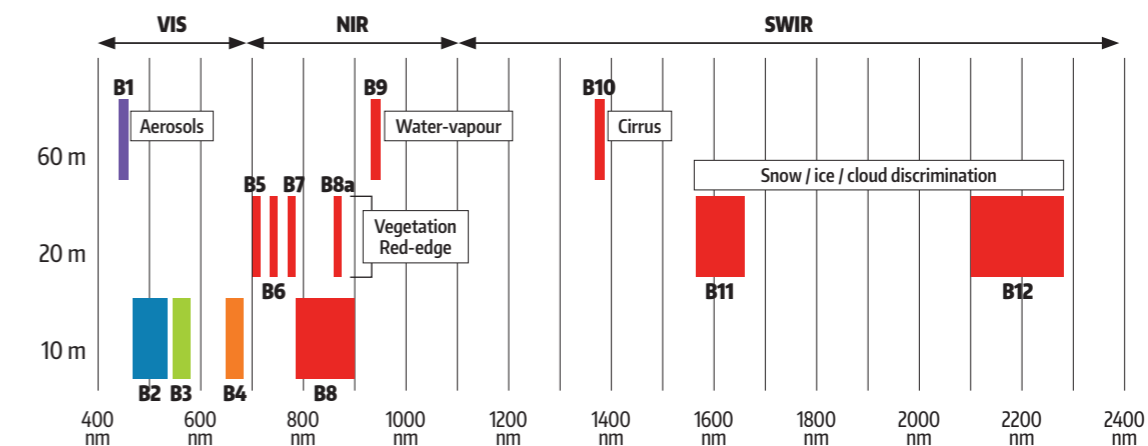
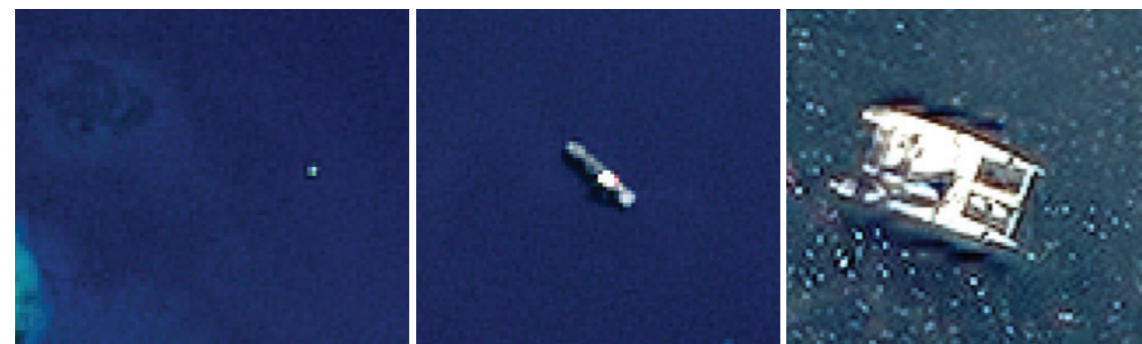

**Figure 55:** Spectral bands and resolution of the Sentinel-2 MSI sensor (after © ESA).

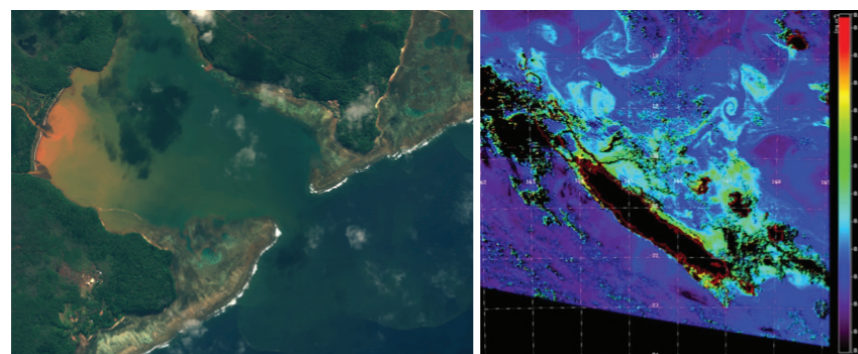

**Table 17:** Relation between resolution and image coverage.

Sensor and vector	Resolution	Geographic cover
Radiometry of meteorological satellites	3 km	1/3 of the globe
Sentinel-2 MSI	10.00 m	290 km (East-West) x 15,000 km (North-South)
SPOT-6	3.00 m	60 km (East-West) x 600 km (North-South)
Pléiades	0.70 m	20 km (East-West) x 600 km (North-South)
Worldview-3	0.30 m	11.5 km (East-West) x 112 km (North-South)



**Figure 56:** Left, detection of a “mineral” object on the water’s surface by high-resolution imaging radiometry; centre, recognition of a ship by high-resolution imaging radiometry (same resolution and same scale as the image on the left); right, identification of a catamaran with a composite hull by very high resolution superspectral imaging (© ESA 2017, © DigitalGlobe 2017, traitements BLUECHAM SAS).



**Figure 57:** Left, turbid plume after heavy rain in July 2013, Baie de Port Boisé (New Caledonia) (© DigitalGlobe 2013, traitements BLUECHAM SAS); right, phytoplankton estimate from the MODIS radiometer (© IRD, Dupouy et al. 2014).

The images collected by imaging radiometers have numerous applications in the marine environment:

- estimated turbidity (water quality)
- estimated chlorophyll-a (an essential parameter for identifying areas with a high concentration of phytoplankton)
- temperature of the water’s surface
- analysis of the coastline
- state of coastal vegetation, mangroves and sea grass beds
- erosion.

Cloud cover is a significant hindrance for imaging radiometers as they cannot see the ground through clouds.

### IV.2.1.2. Radar sensors

Radar imaging sensors are active sensors. They generate their own source of illumination in the microwave band. They therefore record that part of the microwave radiation reflected by the targets illuminated. These sensors have two major advantages: they can make images at night and the microwaves can pass through cloud cover. On the other hand, these sensors require a lot of energy to make their measurements (Baghdadi and Zribi 2016b).

A distinction is made between synthetic aperture radars (SAR) and side-looking airborne radars (SLAR):

- synthetic aperture radars use the vector’s displacement to make a series of successive measurements to improve the signal resolution
- side-looking airborne radars make their measurements from the side as the vector moves. Their resolution is directly linked to the antenna’s aperture (its size) and the sensor’s altitude.

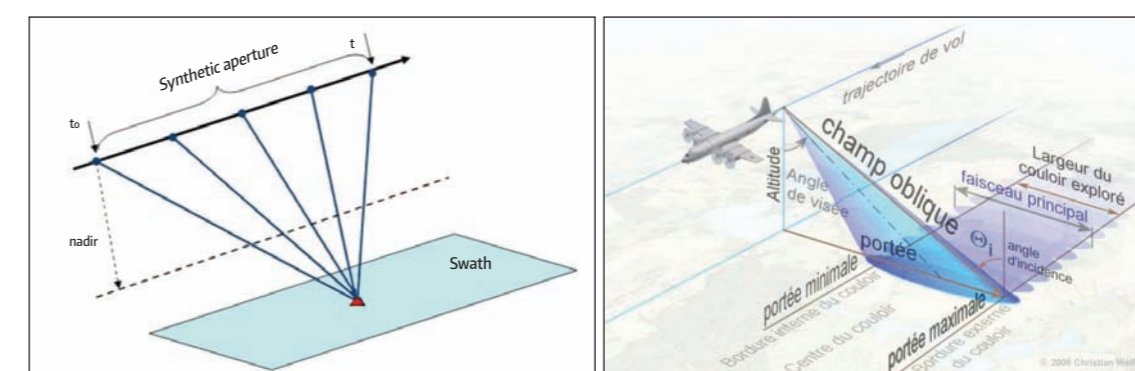

Principle of a synthetic aperture radar (source: Tarata & Vasile 2017).

Principle of a side-looking airborne radar (source: www.radartutorial.eu).

**Figure 58:** Principles of radar sensors.

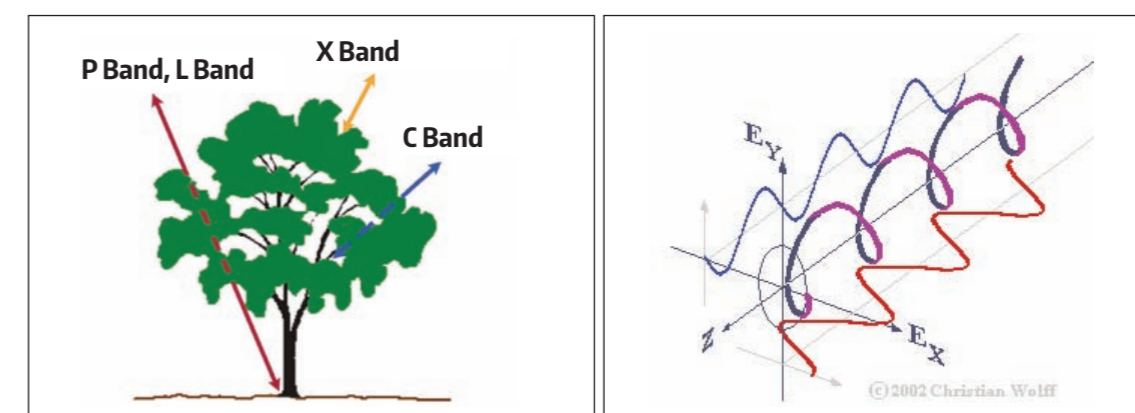

Different interactions between a target (tree) and the different radar waves (source: Earth Imaging).

Vertical (blue) and horizontal (red) polarisation of an electromagnetic wave (source: Christian Wolff).

**Figure 59:** Interaction of the radar signal with the targets and its signal polarisation.

The main features of these sensors are:

- the radar band used which is more or less sensitive to atmospheric disturbances and adapted to the targets sought
- the vertical and horizontal polarisation of the radar wave (emit and receive) which will be more or less backscattered depending on the targets.

Unlike imaging radiometers, imaging radars record the intensity (or quality) of the signal and the phase of the signal received (signal oscillation angle). To be useable, this type of image needs specialist pre-processing. To track and monitor human activity at sea, intensity is most frequently used measurement. It corresponds to the intensity of the radiation backscattered and depends on the wave length, the target surface area and its roughness. Radar data is therefore often used to detect objects of interest or suspicious objects. Recognition or identification of the objects then requires additional data, such as AIS, VMS or imaging radiometer data.

Radar images can also be used to detect and track pollution and oil spills and to estimate oceanographic parameters such as wave trains.

As for imaging radiometers, the higher the radar's resolution, the smaller the extent of the geographic coverage.

The vectors used are mainly aerial vectors (aircraft and drones) or satellites. The type of vector used affects:

- the geographic coverage imaged which depends on the vector's altitude and travel
- the spatial resolution of the images which depends on the sensor and the vector's altitude (for a given sensor, the higher the vector's altitude, the smaller the image spatial resolution)
- vector revisit.

**Table 18:** Relation between resolution and image coverage for the RADARSAT sensor.

Type of radar measurement	Resolution	Image width
SpotLight	1.5 m	18 km x 8 km
Ultra-Fine	3.0 m	20 km x 20 km
Fine	5.0 m	50 km x 50 km
Wide	12.5 m	150 km x 150 km
ScanSAR	25.0 m	300 km x 300 km

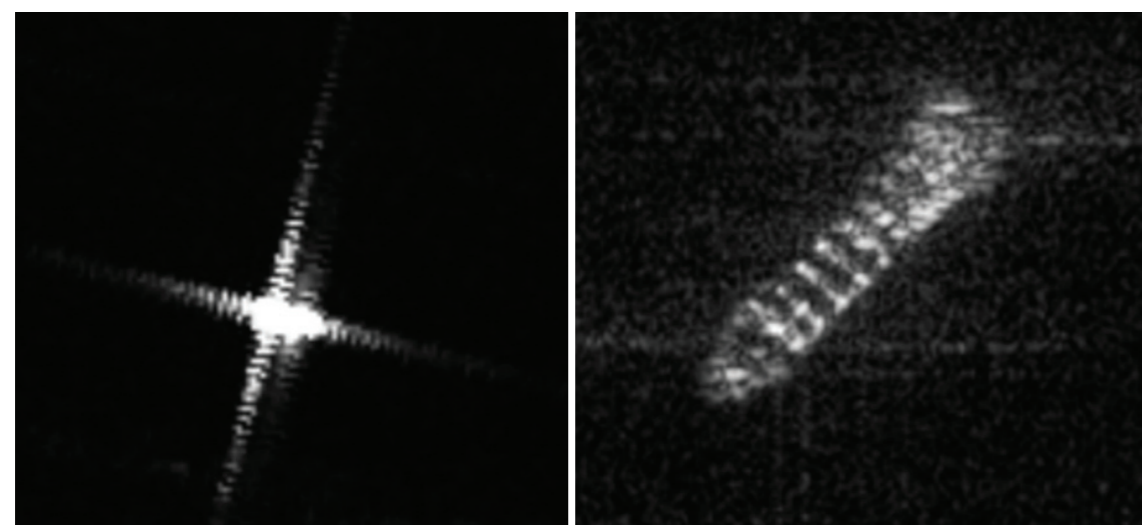

**Figure 60:** Left, an ore carrier detected by the Sentinel-1 radar at 25m (© ESA); right, a cargo vessel observed by RADARSAT-2 Ultra Fine at 3m (© MDA).

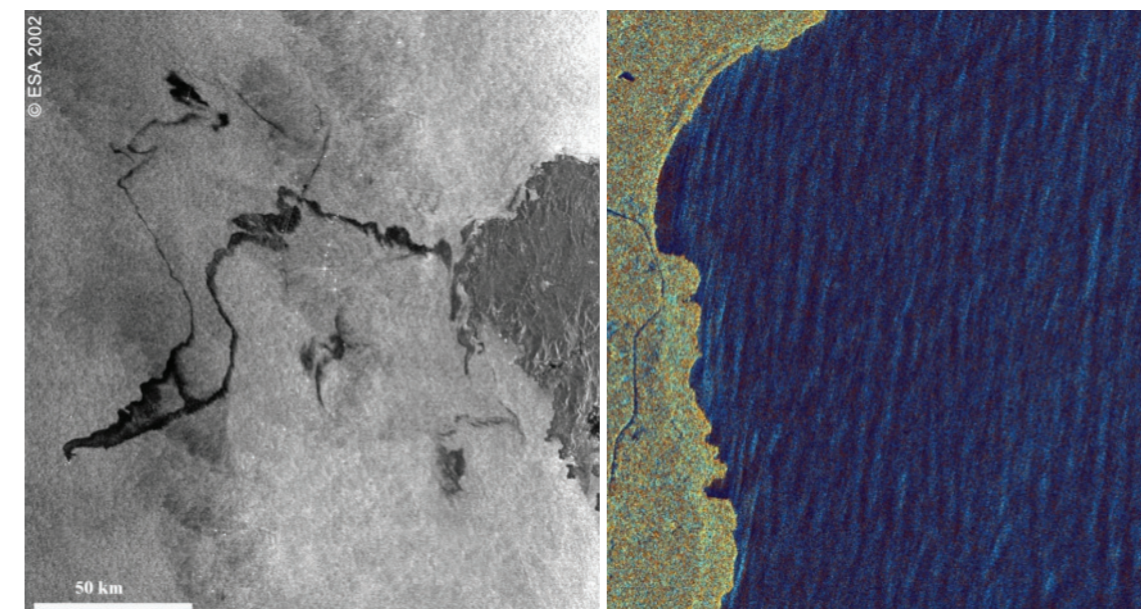

**Figure 61:** Left, detection of an oil spill from an ENVISAT (© ESA) image; right, detection of wave trains by ALOS PALSAR (© JAXA, BLUECHAM SAS processing).

## IV.2.2. Airborne resources

### IV.2.2.1. Plane or helicopter airborne imaging

The sensors that can be taken onboard a plane or helicopter are:

- multispectral or hyperspectral imaging radiometer
- synthetic aperture radar
- side-looking airborne radar.

The resolution depends on the vector's flight altitude (between 100 and 1,000 metres for a helicopter and between 5 and 15 kilometres for planes); generally, the images have a resolution of between several metres and 10 cm.

The spatial resolution of the images obtained is expressed in metres or decimetres depending on the sensor and the altitude. The geographic coverage achieved in a single flight varies because it depends on the sensor used, altitude and type of vector (autonomy). Similarly, regular revisits to the sites by this process are uncertain and unpredictable unless missions are pre-planned. The data collected is downloaded from the sensor on return from the missions ready to be processed. Processing includes geometric and radiometric corrections which can be complex because of the variability in the images taken and sensor's variable exposure to the sun.

Costs for this type of system include the cost of the aerial campaign (aircraft and crew + sensor) as well as the cost of pre-processing and analysing the data which requires specific hardware and software (image processing) and signal and/or photogrammetry processing skills. The acquisition and processing cost varies between USD400 and USD800 per square kilometre (Selbe 2014).

#### IV.2.2.2. Drone airborne imaging

Drones mainly carry multispectral imaging radiometers with 4 or 5 bands. Imaging radars, because of the size of the antenna and their weight (around 10 kg), are currently only carried by mid-to-long range heavy (military) drones.

The image acquisition process is similar to that in aircraft. Drone sensor payloads are currently multispectral radiometers with 4 or 5 bands whose spatial resolution can be as small as 2 cm. The data collected can be directly transmitted to the drone pilot centre as it is collected. Mid-endurance professional drones can be used for around two hours and up to 50 km from their base. However, this type of drone is sensitive to weather conditions (wind and rain). Long-endurance professional drones or military drones have greater autonomy (8-10 hours to over 20 hours), a greater range of action and are less sensitive to weather conditions.

However, large drones require heavier infrastructure and often depend on the availability of a take-off/landing area and are subject to stricter regulatory constraints.

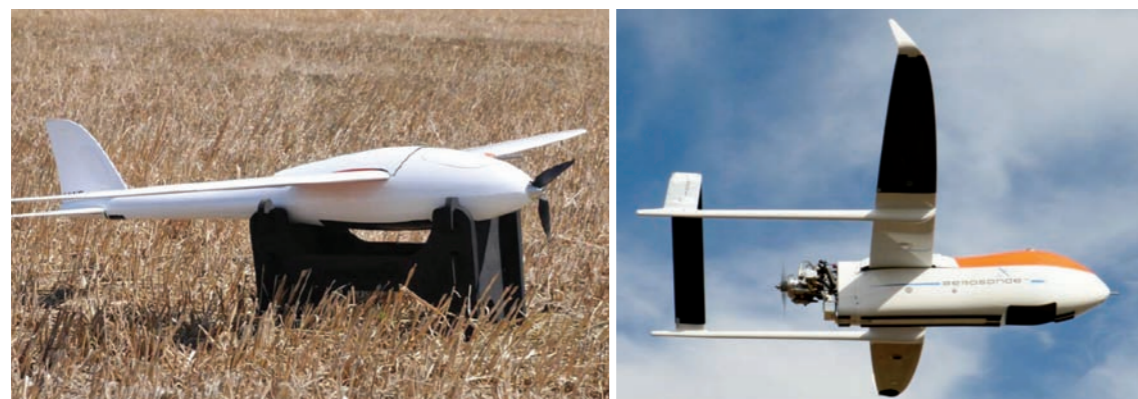

**Figure 62:** Left, mid-endurance professional drone; right, long-endurance professional drone (source: Smith 2016).



**Figure 63:** Airbus Qinetiq Zephyr 7 drone (source: ARS Technica).

Aerial imaging is a rapidly growing sector and high-altitude long endurance drones have interesting capabilities for collecting images at sea. For example, the very long endurance Triton drone developed by NASA has an endurance of over 24 hours and can collect almost 2,000 km<sup>2</sup> of data. It has been specifically designed to operate over the ocean. This type of drone will be available around 2020 (Smith 2016). The Tekever AR5 drone from CLS's REACT service is dedicated to civilian operations for the European Maritime Safety Agency and has an autonomy of 8 to 10 hours.

Stratospheric drones (SPS), positioned at the limit of space, were first developed to act as telecommunication relays. They have been configured to remain for a long time in geostationary flight above a given sector. There are several types of stratospheric drones: zeppelins or aircraft drones. Thalès is currently developing its Stratobus. This zeppelin-type stratospheric drone is 110 metres long and can transport a 250 kg payload at an altitude of 20 km for one year in a geostationary position. The coverage range of the Stratobus is around 400 km under the drone.

Still in the research and development phase, the Airbus Qinetiq Zephyr prototype has demonstrated its endurance with a 330-hour flight. However, at 50 kg, its payload capacity (weight that can be taken onboard in flight or the number and types of instruments) is less than that of the Stratobus. The Qinetiq Zephyr is not geostationary, but it can reduce its flight speed to increase its presence over certain areas.

The purchase cost of drones for this type of application first depends on the drone (Banks, Muldoon, and Fernandes 2016; Graham, Peter 2016; Selbe 2014):

- the cost of mid-endurance drones ranges between USD20,000 and USD100,000
- the cost of long-endurance drones varies between USD300,000 and USD600,000
- the cost of military drones is estimated to exceed USD10 million.

The cost variations reflect the variable offers. Drone suppliers offer different options:

- drone and sensor only
- drone, sensor and associated annual software licence
- drone, sensor and subcontracting to process and produce the added value
- services offer using a drone for specific applications.

For the options involving the purchase of the drone, sensor (and even the software), the total cost must also include training and employing two or more operators for data acquisition missions and the processing cost including hardware and software investment and qualified labour.

#### IV.2.3. Satellite resources

In 2018, more than 100 satellites orbiting around the Earth were tasked with observing and measuring its surface. Since the launch in 1972 of the Landsat mission, the number, precision and quality of satellite sensors has steadily increased. Today, the most precise sensor has a resolution of 30 cm, and space agencies launch constellations of several satellites to ensure regular revisits.

To monitor human activities at sea, the satellites able to produce usable data are low orbit satellites. Images with a resolution of between 30 m and 30 cm can be produced in low orbit using imaging radiometers of 100 to 1 meter with synthetic aperture radars. The satellites are currently placed in the two specific orbits:

- Sun-synchronous polar orbits for satellites with an imaging radar payload. Each given satellite:
  - systematically passes a given point at the same time. The most favourable acquisition conditions for imaging radiometers are between 10.00 am and 2.00 pm
  - flies over each site under the same conditions at regular intervals from a couple of days to several days
  - when the satellite is “agile”, the observation with an angle of incidence can reduce the revisit to one day
- sun-synchronized dusk-dawn polar orbit for satellites with a synthetic aperture radar. Each given satellite:
  - systematically passes at dawn and dusk over a given point (around 4-6 am and 4-6 pm)
  - flies over each site under the same conditions at regular intervals from a couple of days to several days.

A single satellite cannot provide a systematic daily visit; at present a constellation of 4 to 5 satellites is required for this purpose.

The acquisition frequency is used to distinguish between two main classes of satellites: systematic acquisition satellites and satellites on tasking.

### IV.2.3.1. Systematic acquisition satellites

Systematic acquisition satellites systematically perform their acquisition according to a pre-established program. This programming plan may cover the entire world (e.g., Aqua and Terra satellites), emerged land and the coast (Landsat-8 and Sentinel constellation satellites) or sectors of specific interest (Venüs satellite). The satellite’s programming plan also defines whether the sensor conducts an acquisition at each pass (Landsat-8) or at frequencies defined according to area (Sentinel-2).

**Table 19: Main systematic acquisition satellites or constellations for monitoring human activity at sea.**

Satellite or constellation	Number of satellites	Sensor	Resolution	Swath	Revisit
Landsat-8	1	Radiometer	14.75m	190 km	16 days
Sentinel-2	2	Radiometer	10 to 60m	290 km	5 à 10 days
Sentinel-1	2	Radar	20m	290 km	3 à 12 days

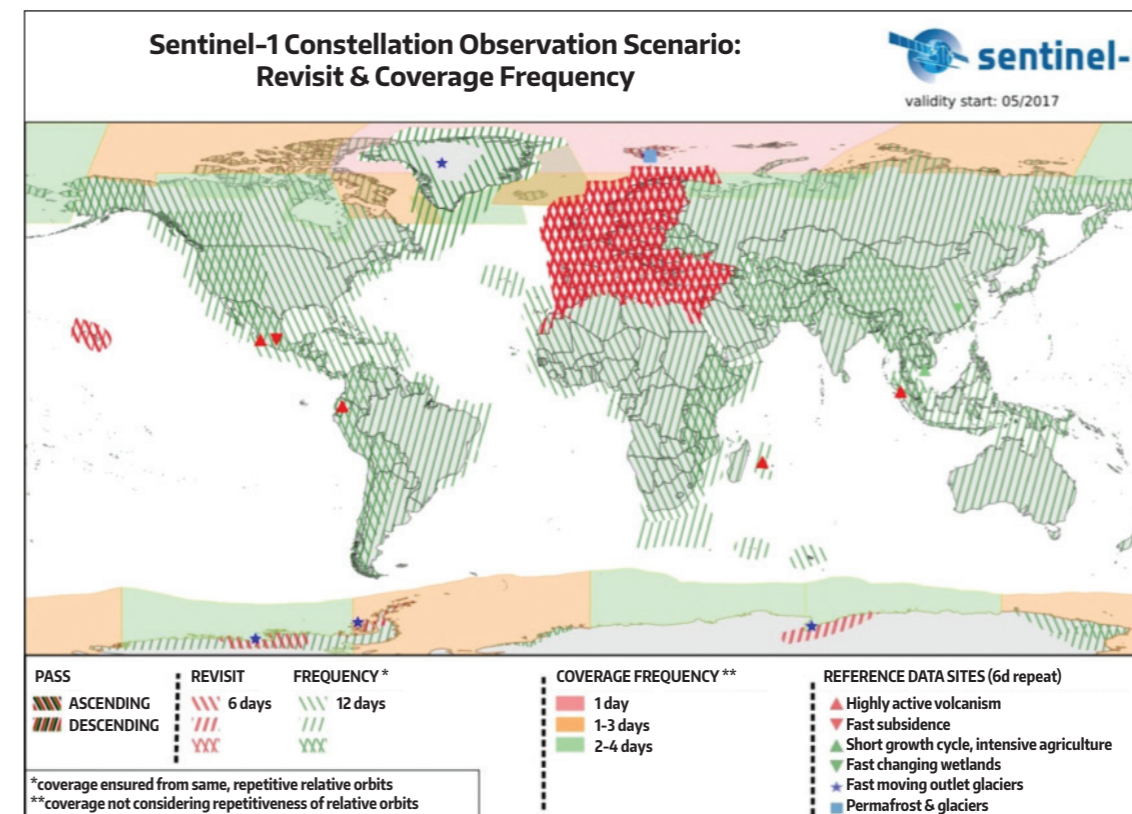

**Figure 64: Programming plan for Sentinel-1** (source: ESA).

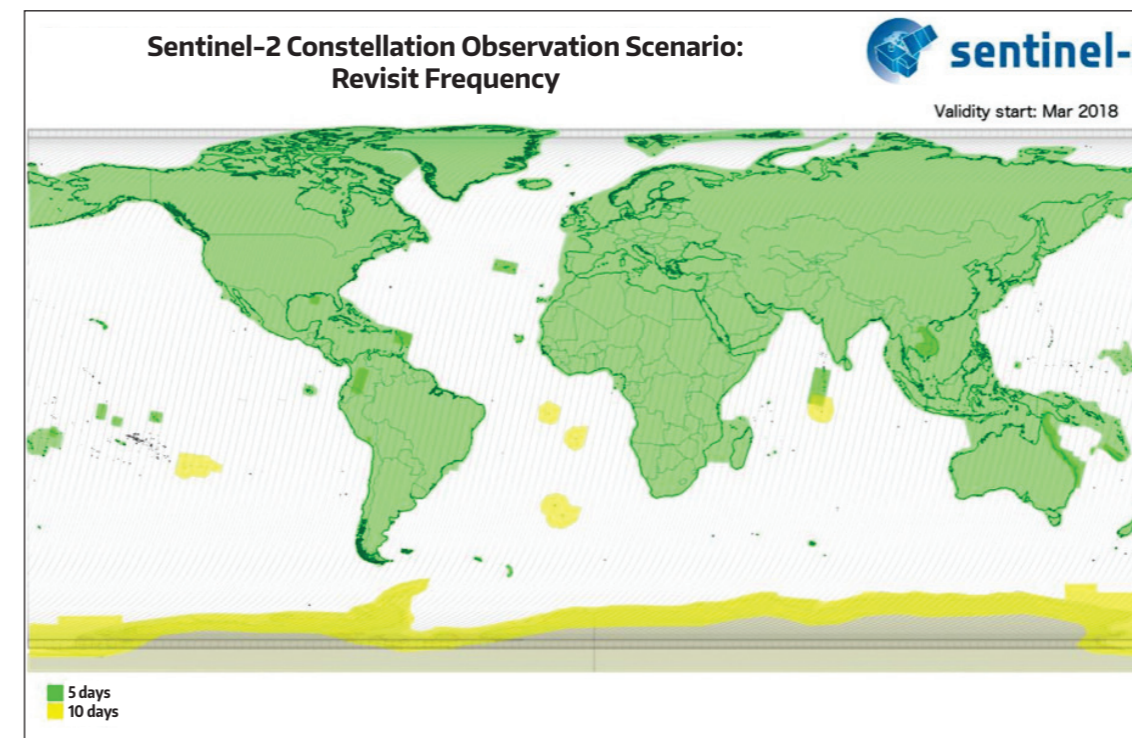

**Figure 65: Programming plan for Sentinel-2** (source: ESA).

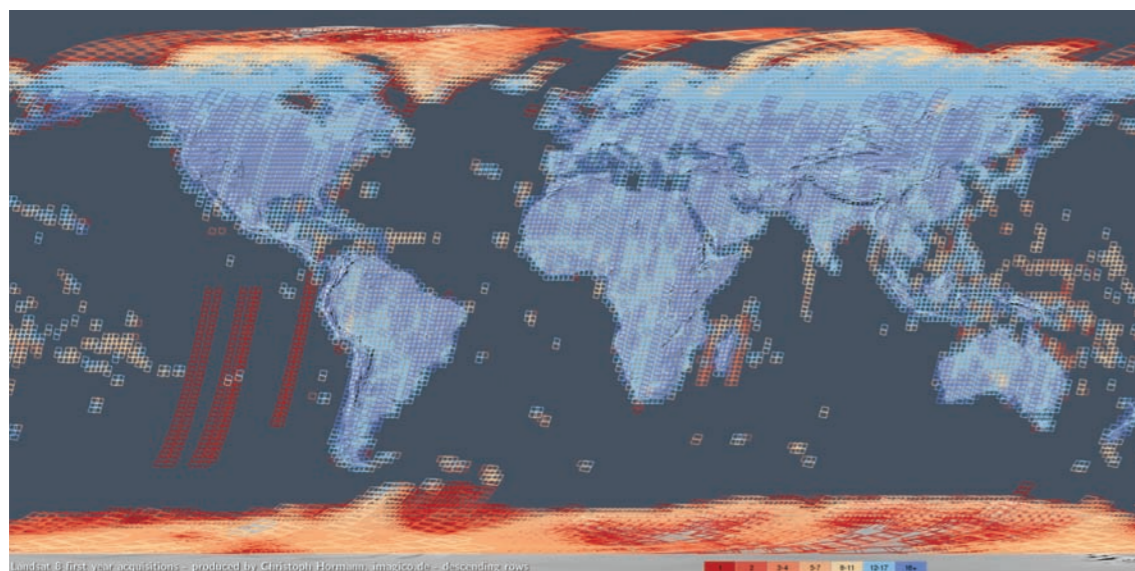
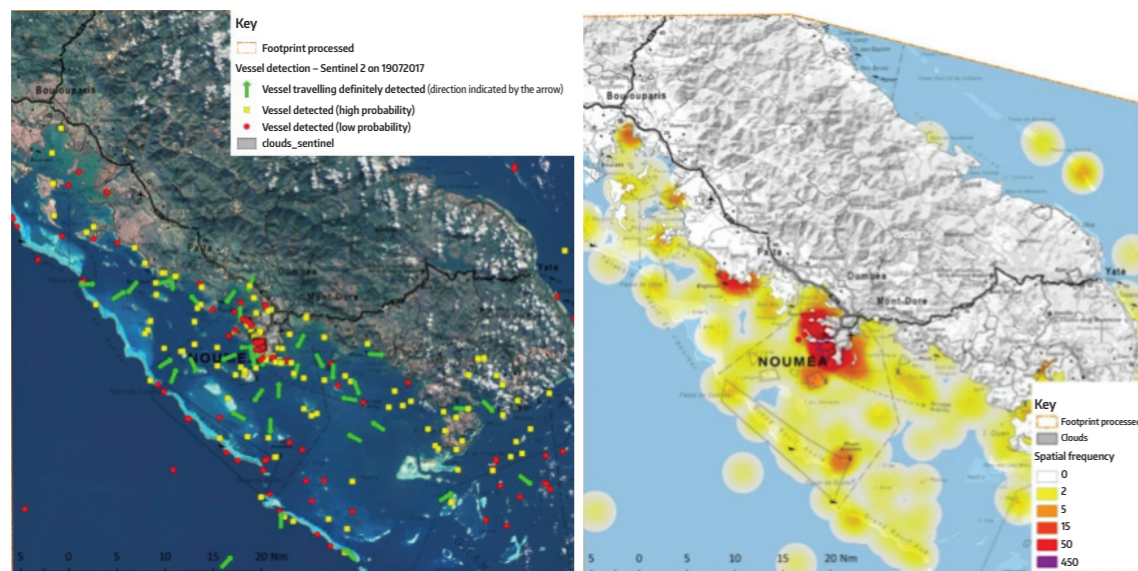

**Figure 66: Landsat-8, first year of acquisition** (source: Ch. Hormann, imagico.de).

The programming plans do not cover the entirety of the EEZs of New Caledonia, Wallis and Futuna, French Polynesia and Pitcairn.

The advantages of systematic revisit satellites/constellations are:

- the regular acquisition of data about the sectors covered
- a predictable frequency
- free access to the licences for this data since 2011 from USGS/NASA and ESA.



**Figure 67: Detection of boats (left) and frequency map from data from the Sentinel-2, constellation** (© ESA, Andreoli, Kinne, and Lille 2017).

While access to Landsat and Sentinel data licences are free, the costs associated with exploiting this data include its processing to extract the desired information from the volume of data analysed. For example, Landsat-8 produces 500 GB of raw data each year and the Sentinel-2 constellation generates 1.4 TB of data each year about New Caledonia alone.

The New Caledonia Department of Maritime Affairs is currently trying to estimate visit frequencies to the remote islands and islets using data from Sentinel-2 in conjunction with Telespazio.

### IV.2.3.1. Satellites on tasking

Satellites on tasking form the vast majority of satellites and constellations currently in service. The satellite or satellites are programmed to conduct acquisitions over the requested areas. These satellites therefore have the ability to focus their observations on targeted territories for one to several days depending on the operator.

**Table 20: Main satellites on tasking or constellations useable to monitor human activities at sea.**

Satellite or constellation	Number of satellites	Sensor	Resolution	Swath	Revisit
Deimos-1	1	Radiometer	22 m	650 km	1 day
RapidEye	5	Radiometer	6.5 m	77 km	1 day
SPOT 6-7	2	Radiometer	3 m	60 km	1 to 3 days
Pléiades	2	Radiometer	70 cm	20 km	1 to 3 days
DigitalGlobe	5	Radiometer	50 cm - 30 cm	15 to 11 km	1 day
TerraSAR-X TanDEM-X	2	Radar	1 m	4 to 27 km	11 to 2.5 days
Cosmo-Skymed	4	Radar	1m	10 to 200 km	12 hrs to 2.5 days (1 sat.) 3 to 12 hrs (4 sat.)
RADARSAT	1	Radar	1.5 m	20 to 300 km	3 to 12 days

Programming requires prior knowledge of the areas of interest to monitored. Satellites must also be programmed beforehand; space agencies offer programming times of between 6 and 12 hours prior to the actual acquisition. In practice, space agencies, like Airbus and DigitalGlobe can, under certain conditions, programme their constellations in less than 6 hours.

The satellite images from this group are usually charged per kilometre. The price varies depending on the resolution. Additional costs can also be added to the base price, such as a restriction for cloud cover of less than 5% for imaging radiometers and priority programming. For specific missions, like monitoring or tracking certain sites requiring the regular acquisition of data over a specified period, the main space agencies provide tailored solutions.

**Table 21: Public prices for the main satellites on tasking and constellations suitable for monitoring human activities at sea.**

Satellite or constellation	Cost / km <sup>2</sup> (USD)	Maximum collection size
Deimos-1	0.25/km <sup>2</sup>	1,000 km <sup>2</sup>
RapidEye	1.28/km <sup>2</sup>	3,500 km <sup>2</sup>
SPOT 6-7	5.75/km <sup>2</sup>	500 km <sup>2</sup>
Pléiades	21.25/km <sup>2</sup>	100 km <sup>2</sup>
DigitalGlobe	24/km <sup>2</sup> to 29/km <sup>2</sup>	100 km <sup>2</sup>
TanDEM-X	0.25/km <sup>2</sup> to 135/km <sup>2</sup>	15,000 km <sup>2</sup> to 50 km <sup>2</sup>
Cosmo-Skymed	0.20/km <sup>2</sup> to 120/km <sup>2</sup>	10,000 km <sup>2</sup> to 100 km <sup>2</sup>
RADARSAT	0.04/km <sup>2</sup> to 50/km <sup>2</sup>	90,000 km <sup>2</sup> to 144 km <sup>2</sup>

#### IV.2.4. Data transmission to the ground segment

Data transmission to the ground segment includes:

- downloading the data to a land Earth station
- transferring the data from the land Earth station to the ground segment.

Routinely, it takes several days to transfer the satellite data from the satellite to the user. For monitoring, rapid access to the data collected by the satellites is crucial. There are now several solutions for transferring the data to the ground segment:

- creation of a land Earth station directly at the ground segment
- use the Space Data Highway;
- use the interoperability of cloud computing.

Whatever the transmission mode, the frequency at which a satellite image of a site can be obtained now depends on the satellite's or constellation of satellites' revisit capability.

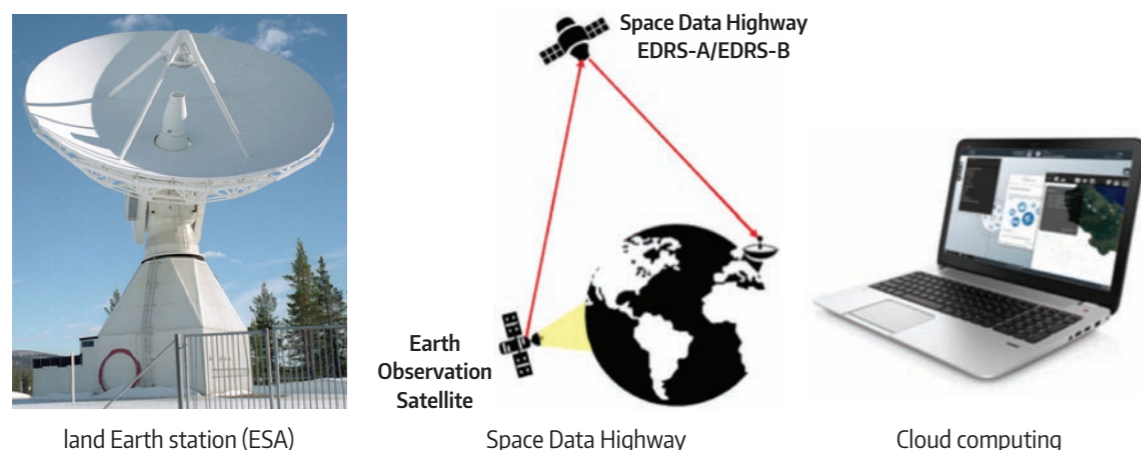

**Figure 68: Satellite data transmission modes** (sources: left, European Space Agency; centre, BLUECHAM SAS; right, BLUECHAM SAS).

##### IV.2.4.1. Land Earth station

A satellite land Earth station can be used to quickly programme satellites and download data directly after its acquisition when the satellites are in range of the receiver antenna. A land Earth station can interact with the satellites within a zone measuring 3,000 km on either side of the station. Thus, programming and data downloading can be completed within a couple of minutes during the satellite's passage. The cost of building a land Earth station varies between USD20 and USD50 million (Loubersac, Galletout, and Péré 2018). The costs vary depending on the constellations covered by the station (simple mission with a space agency or multi-missions with several space agencies), its transfer capacity and associated processing capacity (data decompression, signal enhancement and sensor calibration). For example, CLS operates the Vigisat station in Brest (France) and SEAS-OI in La Reunion on behalf of the European Maritime Safety Agency (EMSA) to detect ships and monitor oil spills in Europe.

##### IV.2.4.2. Space Data Highway

The Space Data Highway is a system of two geostationary satellites put into orbit by Airbus, and used to recover data from low-orbit Earth observation satellites and send it directly to a land Earth station. The transfer is made by laser with a capacity of 1.8 GB/s. The Sentinel 1 and 2 constellations download their data via the Space Data Highway; the data is therefore available within 2 to 4 hours after its acquisition. This service is provided directly by Airbus to space agencies.

##### IV.2.4.3. Cloud computing

Interoperability and Cloud Computing can minimise transfer times and the associated processing in land Earth stations by directly using the network of land Earth stations operated by space agencies. The data is no longer recovered directly but rather a service flow via the Internet (or web service) is connected to the applications that display and analyse the data in the ground segment. This reduces the data delivery time by directly using the data on arrival in the land Earth station and reduces the volume of data transferred. A demonstration system created by BLUECHAM with the DigitalGlobe space station, at the request of the Government of New Caledonia for the Armed Forces, Maritime Affairs, CEPPOL and CGE-ORSEC showed that this type of system can deliver images every day (Andreoli, Kinne, and Lille, 2017):

- with a resolution of 50 cm and 30 cm
- between 40 and 150 minutes after acquisition by the satellite
- directly useable by operators.

This solution has the advantage of minimising transfer and licence purchase costs for the images as value added products are delivered to the users rather than raw images.

##### IV.2.5. Ground segment processing

Satellite images – radar or optical – require specialised processing including measurement calibration, data georeferencing and signal analysis to extract the basic monitoring information. The calibration and georeferencing steps are now standardised and – for the marine sector – can be automated with a guaranteed robust result. Signal analysis resulting in the creation of thematic information is more complex to implement as it depends on the desired tracking/monitoring aims. Physical data (classifications) or object detection is currently automated and has an excellent level of detection.

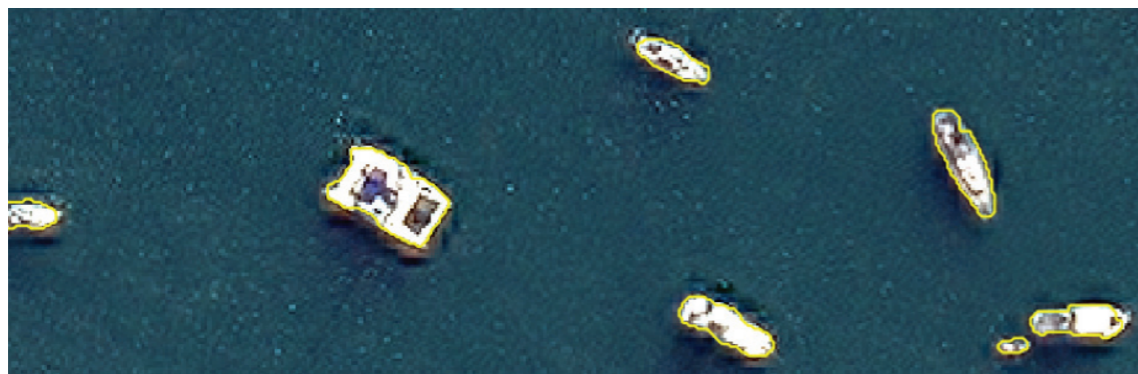

**Figure 69:** Example of automatic detection of boats from 30 cm data (© DigitalGlobe 2017, BLUECHAM SAS processing).

Satellite images must be processed on specialist workstations that are designed physically (hardware) to be able to process several GB of data using professional software. The processing algorithms generally have to be created in the software as these usually only include generic processing tasks.

An image processing workstation costs between USD25,000 and USD30,000 (hardware and software), to which must be added software maintenance, generally around USD5,000 a year. Freeware started to be available on the early 2000s (ORFEO Toolbox and SNAP). However, it is specialised for a type or family of images (e.g., SNAP for ESA's Sentinel data) or still only has limited functions. Then, there is also the cost of one or more highly qualified operators to carry out the processing

With the development of system interoperability and Cloud Computing, companies specialising in processing this type of data now offer subscriptions to services providing access to information. All the processing is carried out by the supplier using its own infrastructure or in the Cloud. The ground segment subscribes to a service (website or web services) and only consumes the data it needs. In this way, the infrastructure and processing resources are shared between several clients who access these services under a subscription. The cost of a subscription varies depending on the size of the area of interest, and the types and frequency of processing requested (DigitalGlobe 2016).

#### IV.2.6. Future missions

Satellites' Earth observation capabilities are growing exponentially with the launch of an increasing number of satellites with infra-metric spatial resolutions and the deployment of micro- and nanosatellite constellations. Initially reserved for the historic space exploration countries (USA, Europe and Russia), countries, such as India, China, Japan, Argentina and the Gulf countries have also recently launched constellations of optical and radar satellites. In a context of rapidly changing capacity, recognition of innovations and future new missions will help determine the choice of equipment and satellite observation solution. This section presents the main future missions and innovations in this field.

#### IV.2.6.1. Constellations of micro-satellites

Since the beginning of the 2010s, several micro- and nanosatellite operating companies have been created: Planet Labs Inc., Urthecast and Spire Global. The principle involves deploying many small satellites (about the size of a shoebox), at low cost and with a short lifespan (CubeSat, Doves and SkySat), to create large constellations of satellites (24 SkySat, between 100 and 200 CubeSat and 149 Doves).

The size of these satellites means they are equipped with small radiometers able to acquire images at the scale of a metre. On the other hand, these constellations allow for higher revisit rates. Planet Labs Inc., for example, operates 149 Doves, together with constellations of mid- and very high-resolution satellites. This type of constellation allows for hourly revisits at some sites.

Performance and quality tests (d'Angelo, Mátyus, and Reinartz 2016) show that the radiometric quality of the data is poorer and the image processing requires additional effort compared with the data produced by conventional satellites.

Conclusive acquisition tests for a 90-second video of a specific target from a SkySat satellites have also been conducted.



**Figure 70:** Example of a processed SkySat image (Calibration, orthorectification and signal boost) (© Planet Labs Inc.).

#### IV.2.6.2. The future Pléiades Néo and PAZ/TerrSAR-X mission

Pléiades Neo is a constellation of four satellites with a multi-spectral imaging radiometer and a resolution of 30 cm. Airbus plans to launch this constellation around 2020 to add to the existing Pléiades constellation. The addition of these four satellites would reduce the current revisit rate from between one and three days to daily.

In February 2018, the Spanish PAZ radar satellite joined the TerraSAR-X and tanDEM-X radar constellation thereby improving the constellation's revisit rate.



Figure 71: Promotion of the PAZ launch in March 2018 (© Airbus).

#### IV.2.6.3. WorldView Legion & Scout constellations

En 2017, MacDonald, Dettwiler and Associates (MDA) et DigitalGlobe ont annoncé le lancement dès 2018 /2019 des constellations Scout et Legion. Ces constellations doivent être en mesure de revisiter certains sites jusqu'à 40 fois par jour (soit toutes les 36 minutes en moyenne) à une résolution comprise entre 30cm et 80cm en utilisant 12 satellites classiques seulement. Les satellites seront lancés sur des orbites polaires héliosynchrones et des orbites de moyenne latitude afin d'atteindre une haute fréquence de revisite (DigitalGlobe 2016).

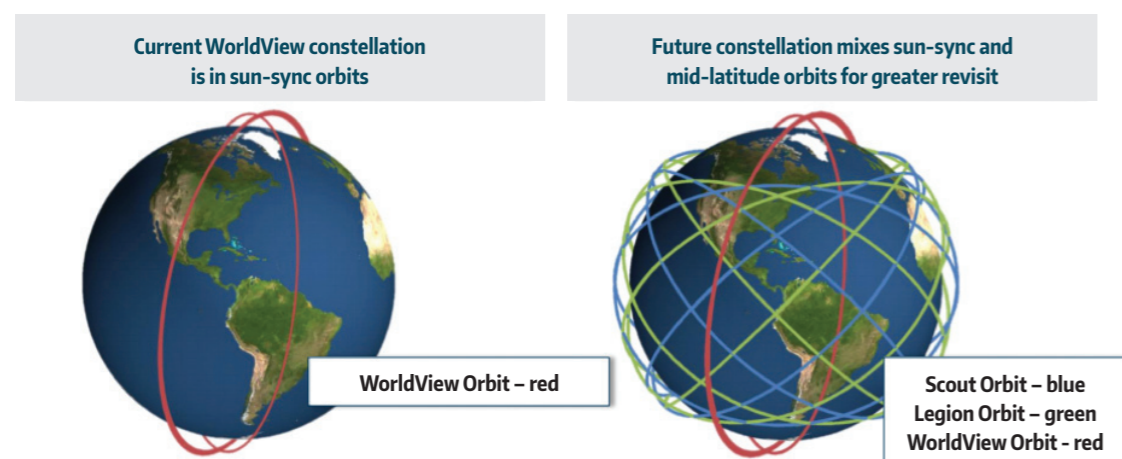

Figure 72: Left, sun-synchronous polar orbits of the Worldview satellites; right, mid-latitude orbits of the Scout and Legion constellations (source: DigitalGlobe).

#### IV.2.6.4. CO3D constellation

The CO3D constellation is a project run by the French Space Agency (CNES) to launch a constellation of four nanosatellites starting in 2022. This constellation would comprise sub-metric (50 cm) imaging radiometer satellites flying in tandem to make three-dimensional acquisitions. This constellation would then be increased by private partners.

## V PHYSICAL PARAMETER MEASUREMENT SENSORS

In this section, physical parameter measurement sensors only refer to sensors used for monitoring and tracking activities at sea. Two main types of sensors are used: surface radar and acoustic sensors. The sensors used to collect physical measurements of the environment and the state of the sea (temperature, salinity, composition) are not addressed in this study.

### V.1. SENSORS AND TYPES OF MEASUREMENTS

#### V.1.1. Surface radar

Surface radars emit microwaves at a low grazing angle. These waves are backscattered by the objects and their surface roughness (ship, buoy or wave). The backscattered waves (echoes) are received and filtered to remove noise (Selbe 2014). Radars are usually placed in a clear space to improve their visibility (an antenna attached to a ship or aircraft).



The radar records the echo and by repeating the measurements over time, all the echoes form a radar track. Radars detect objects in this way. Identifying the objects involves exploiting additional data (AIS, imaging).

The distance covered by the radar is directly proportional to the height at which the sensor is placed:

$$\text{distance} = 2.23 \sqrt{\text{radar altitude}}$$

Figure 73: Surface radar for coastal surveillance (© Kelvin Hughes).

The new generations of High Frequency Surface Wave Radar (HFSWR) use the properties of wave propagation on the water's surface in the high-frequency band (Maresca et al. 2014). This type of radar can see beyond the radar's horizon line and cover much larger expanses (up to 200 nautical miles, Couchat 2018). They can be used for continuous monitoring over a very large area. Coupled with other resources (e.g., AIS, fishing fleet tracking system), they provide collaborative identification.



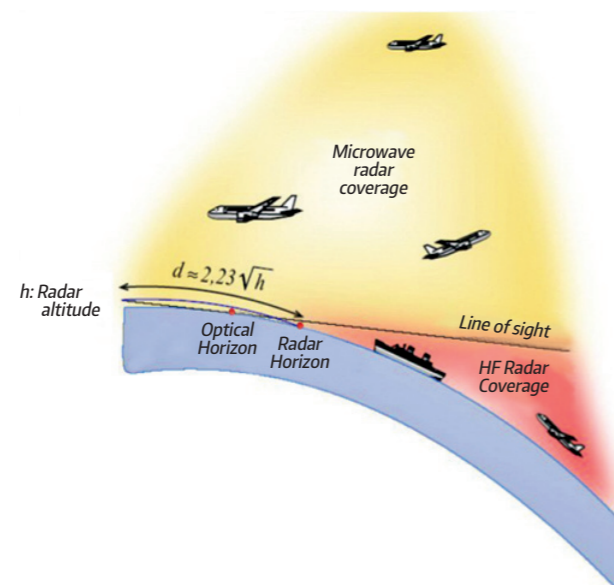

**Figure 74:** Principle of the HFSWR or HF radar HF (© DigiNext).

The HFSWR radar also improves the detection of small sized vessels, like trawlers (20/25m) at a considerable distance (200 nm). HFSWR solutions based on the bi-static principle provided by Diginext, combine a transmission site with one or more receiver sites (which may be linked) with antenna fields (i.e., several antennas coupled together). This type of solution can cover even greater surface areas. Finally, the HFSWR radar can also collect additional environmental data such as the condition of the sea surface (waves), and detect tsunamis, pollution and oceanographic parameters (Couchat 2018).



**Figure 75:** Example of a Stradivarius HFSWR bistatic radar (© Diginext).

The cost of radar platforms depends on the radar's sophistication, power and coverage. A simple navigation radar in a port costs between USD2,000 and USD8,000. The most sophisticated coastal radars cost USD10,000. The HFSWR radar is the most expensive as it includes a radar transmission network and receiver stations (Selbe 2014).

## V.1.2. Acoustic sensors

The hydrophone (or passive sonar) is an acoustic sensor that records sounds in the water. Most hydrophones use the change in the water's pressure caused by a sound under the water and convert it into an electric signal using an electroacoustic transducer (Lurton 1998).

Hydrophones can therefore record a sound in various frequency ranges. The sound's frequency range depends on the type of sound (subsea earthquake, animal, motor) and identify what has issued the sound by comparing the sound to a database of sound signatures. A hydrophone's "visibility" circle depends on the water's temperature, salinity, depth and type of sound. On the surface or at a shallow depth (0 to 30 m), hydrophones can capture the sound of a vessel travelling up to 30 km away (Lurton 1998; Nott 2015); the sound emitted by subsea earthquakes can be heard thousands of kilometres away. Generally, hydrophones are used in an array (that is, several hydrophones assembled together on a base) to improve the sensor's capacity (increased sensitivity distance assessment, noise reduction).



**Figure 76:** A hydrophone array (source: Marguer et al. 2013).

An active sonar (*Sound Navigation and Ranging*) is a hydrophone coupled with a sound emitter. An active sonar emits a sound wave and listens to the echoes returned by the objects encountered on the wave's path. Sonars can detect an object and its distance from the sonar by measuring the elapsed time.

The cost of a hydrophone varies depending on its performance; they can range between USD150 and USD1,500 or more (Selbe 2014).

## V.2. VECTORS USED

### V.2.1. Fixed locations (antennas, masts and buoys)

Fixed locations are traditionally used for coastal surface radars (antennas and masts) to raise it up and increase the coverage for this type of sensor.

HFSWR radars require the installation of two networks of antennas for signal transmitting and receiving. The transmitting antenna requires a site of about 150x150 m, with 16 x 10 m high masts. The receiving antenna site is about 150x1000 m with 32 antennas on 2 m high masts. A reduction in the site width can be examined on a case-by-case basis with the risk of undermining the target location precision.



**Figure 77:** Network of transmitting antennas for a HFSWR (© DigiNext).

This type of installation involves a ground footprint which should be considered in terms of cost and also acceptance by neighbouring residents. Still, the height of the antenna significantly reduces any visual pollution. They are virtually invisible to the naked eye just a few hundred metres away. The principle of the antenna field of the HFSWR developed by DIGINEXT considerably limits its transmission power and the creation of back lobes (liable to be directed towards any neighbouring residents).

Buoys can also be used as a support for measurement instruments and have already proven their worth for tracking activities at sea by fitting them with cameras, acoustic sensors and AIS relays. However, to form a monitoring and/or tracking system, buoys have to be arranged in a dense network for which the installation and maintenance costs are prohibitive. However, the installation of permanent buoys at certain specific and frequently visited sites can be an option (Selbe 2014).

### V.2.2. Aircraft and ships

For surveillance missions at sea, radars are usually used for air-borne missions (Gardian aircraft). The coverage depends on the mission's autonomy but also the aircraft's altitude. Typically, 2 missions in a Gardian can cover the entire EEZ of Wallis and Futuna.

Hydrophones and sonars can be carried by vessel in the form a rear immersed antenna, or an array<sup>23</sup> towed behind the vessel (lateral sonars). The area covered depends on the vessel's mission.

### V.2.3. Les drones marins

Depuis le début des années 2000, les drones marins et sous-marins ont connu un fort développement avec la miniaturisation et l'amélioration des systèmes de géolocalisation. Dès le milieu des années 2000, ce type de drones avait démontré sa capacité à collecter efficacement des données de l'environnement marin (température, salinité, propriété optique). L'amélioration de l'endurance des drones et l'optimisation des capteurs afin d'opérer sur un support restreint et avec peu d'énergie permettent aujourd'hui d'embarquer certains capteurs pour la surveillance des activités humaines en mer (Maguer et al. 2013 ; Manley 2008).

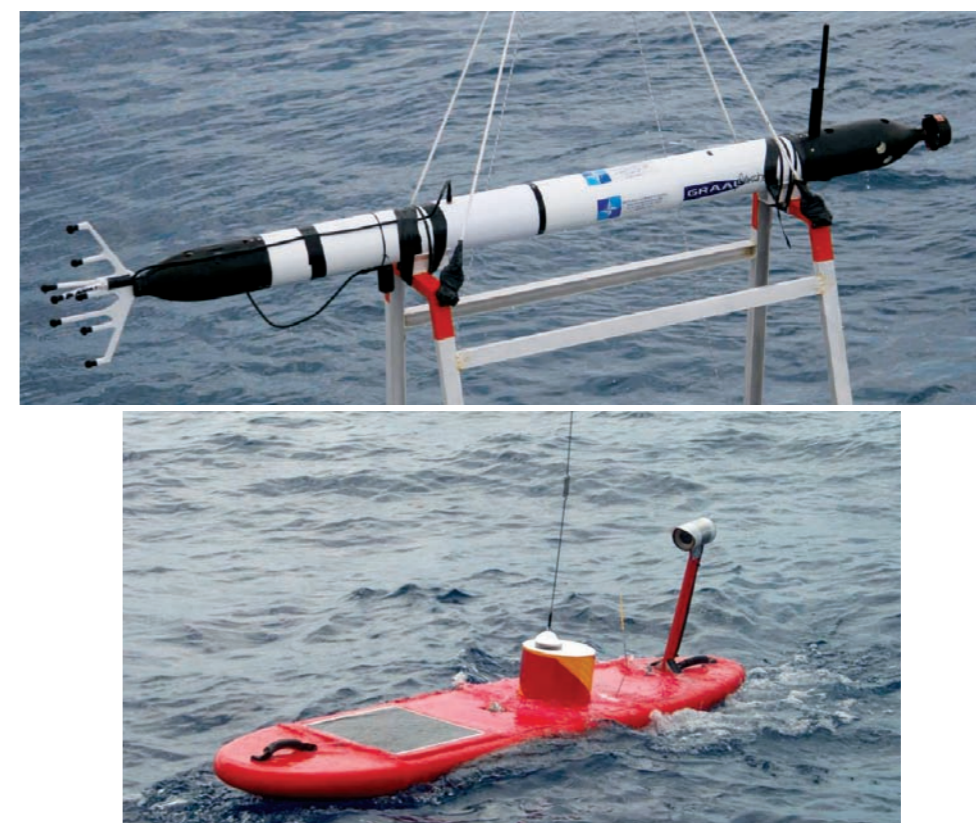

**Figure 78:** Top, eFolaga autonomous underwater vehicle (source: Maguer et al. 2013), bottom, Liquid Robotics's Wave Glider unmanned surface vehicle (source: Manley 2008).

USVs and AUVs are now multimodal platforms carrying a suite of sensors depending on the purpose of the mission.

<sup>23</sup> Submerged device fitted with instruments and towed behind a vessel.

They both use changes in floatability for propulsion while the Wave Glider tends to take greater advantage of wave movement using an underwater sub 4 to 8 metres below the surface. Wave Gliders have unlimited autonomy and coverage in water where the depth is greater than 15 m. USVs can travel several thousand kilometres at depths of up to 1,000 m (Fastwave 2014 & 2015).

Wave Gliders have the advantage of being totally autonomous and use solar panels to produce their own electricity. Their payload is also greater only limited by the need for a battery and the weight of the sensors, which may not exceed a specified maximum. They can also tow an array to increase the number of sensors.

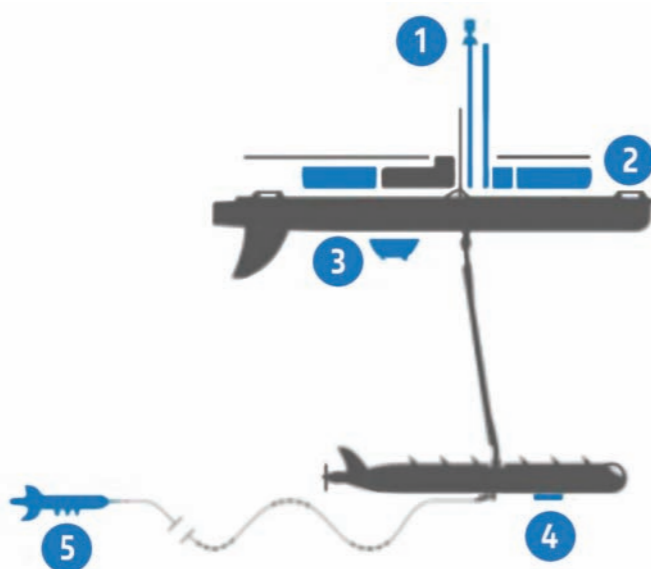

**Figure 79:** Sensor positions on a *Wave Glider* (source: Guyonnet 2016).

AUVs generally have a GPS system to track their path. In addition to environmental parameter sensors, their payload can include hydrophones or acoustic sensors. An AIS sensor and its VHF antenna are also added together with an optical sensor to identify the targets (Guyonnet 2016). USVs can be customised and are currently provided by companies specialising in complex, high-tech systems, such as Assystem.

Liquid Robotics's Wave Glider was equipped with an IS antenna, a hydrophone and camera to characterise the targets identified by the acoustic sensor during a surveillance mission in Pitcairn as part of the Eyes on the Sea project (Liquid Robotics case study). During a four-month mission, the Wave Glider performed acoustic measurements over an area of 131,000 nm<sup>2</sup> AIS reception over an area of 247,000 nm<sup>2</sup>. It travelled more than 10,000 km.

The purchase cost of a USV or AUV varies between USD175,000 and USD500,000. In addition to its purchase, some companies also offer associated services. They operate fleets of these vehicles and only sell the data collected (Liquid Robotics). They remain costly because of the low demand: the industry standards start at between USD120,000 and USD250,000 et 250 000\$ US (Selbe 2014; Banks, Muldoon, and Fernandes 2016).

### V.3. DATA TRANSMISSION

For onshore antennas, the data is transmitted directly by cable between the facility and the ground segment. For radar and acoustic sensors, the data is often processed directly onboard the vessels and the information is sent as a report.

For sensors on USVs and AUVs, the data can be transferred on returning from missions or by telecommunication satellite (Iridium or Inmarsat), if the device is fitted with a transponder. USVs can transmit the data collected continuously. To optimise information transmission, the data is generally pre-processed by an onboard microcomputer and alarms and/or summary reports are sent to the land Earth station. AUVs must surface to upload their data. They can also be equipped with GSM and 3G communication systems to use these networks inshore to transmit their data (Zorn 2013; Fastwave 2015; Maguer et al. 2013; Manley 2008).

### V.4. PROCESSING AND GROUND SEGMENTS

In general, measurement processing software and stations are supplied with the sensors and these types of measurements, taken individually do not require large capacity processing workstations. On the other hand, the creation and use of databases require the installation of a database and the associated storage space.

However, this type of sensor mainly provides detection information (detection of radar tracks and noise). In order to proceed to the recognition and identification steps, these systems are generally coupled with other measurements (AIS, VMS, imaging).

## VI PARTICIPATIVE SYSTEMS

So-called participative systems include tools that allow users to enter information in digital format. Systems like *e-LogBook* or *e-Reporting* as well as public teleservice apps are all collaborative technologies requiring the users to enter the information.

### VI.1. E-REPORTING

*E-Reporting* (Electronic Data Reporting) systems are a digital version of conventional paper report processes (Steele 2016; Masika 2016; FIMS and iFIMS 2014; Oates 2016). They are generally used to compile a report on an activity or fill out administrative documents. Their use is growing today on fishing vessels and are in a pilot phase for customs declarations (notably in Australia).

The system includes software specifically developed for the users' needs. "Users" here should be taken in the broadest sense of the term as it includes the users of the data collected (administrative authorities, managers and scientists) and the users who fill out the form using the online app. The software includes a series of modules that can operate independently of each other or communicate together (Banks, Muldoon, and Fernandes 2016).



**Figure 80:** Cook Island fishers using the Tails e-Reporting app developed by CPS (© CPS "Tuna Catch Monitoring Enters the Electronic Age" 2017).

Apps are generally developed for mobile devices (tablets and smartphones) so that they can be taken to sea (CPS Tails app and CLS Halios app). The more modular the app, the more easily it can be adapted to various situations by selecting certain fields, and making others mandatory. Apps can also be directly linked to the vessel's location system (VMS, AIS) so that the position can be linked to the e-report. The information can be transmitted using a variety of formats, but it is generally verbal (XML, JSON, etc.) or by telecommunication satellite (Iridium, Inmarsat, etc.) or manually downloading the data.

The report is then stored in a database and archived to create tracking indicators, summary reports and export operational data (Banks, Muldoon, and Fernandes 2016).

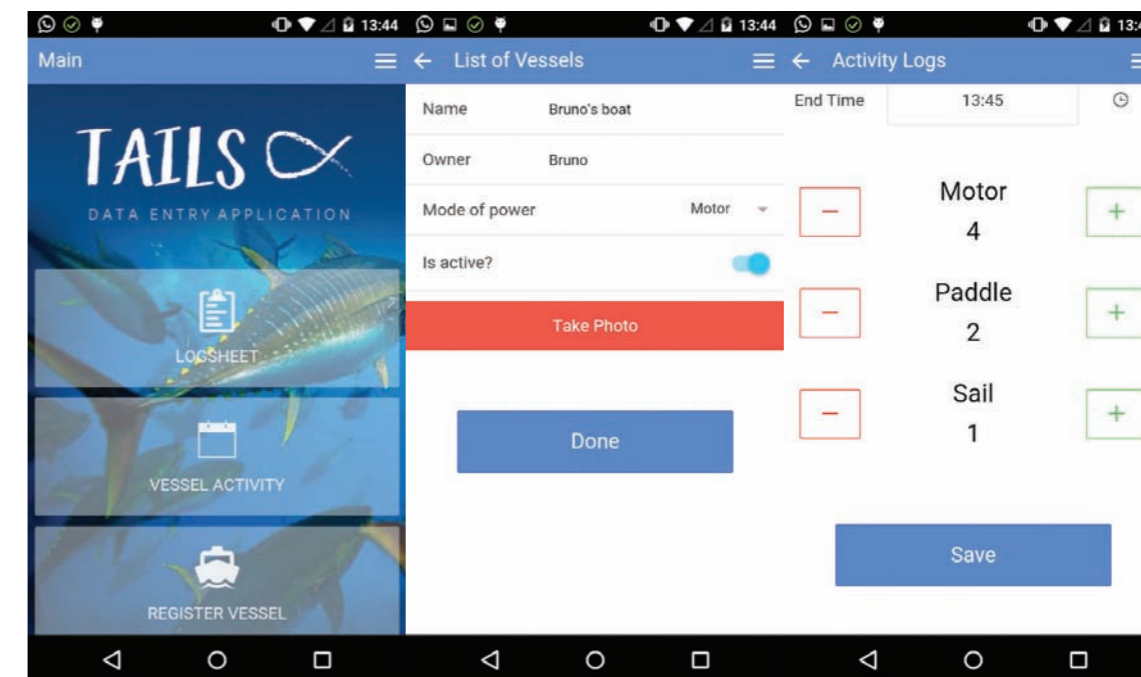

**Figure 81:** Screen shots of the CPS Tails e-Reporting app for collecting small-scale tuna fishing data for the WCPFC (© CPS).

### VI.2. PUBLIC TELESERVICE

Public teleservice apps use the same model as specialist e-Reporting apps. The difference is that these apps' targeted audience for the information reported is the public itself.

Although the Government of New Caledonia's "*Ile propre*" (Clean Island) app was not designed to track and monitor human activities at sea, it is still an example of a public e-Reporting teleservice for reporting waste so that it can be collected. It can be downloaded for mobile devices. The user fills in the specific and targeted fields (location and type of waste), adds photos and comments before saving his or her entry. The app includes a map to help users identify their location.

Public apps suffer from one specific difficulty: they must be adopted by a large number of users to ensure that the information collected is relevant and to ensure its long-term use. These apps therefore must be fun to use or deliver a specific benefit or pleasure to their users.

### VI.3. COST OF DEVELOPING AND MAINTAINING PARTICIPATIVE SYSTEMS

The cost of developing an e-Reporting app varies depending on the number of modules, functions required, ergonomics, etc. Banks, Muldoon, and Fernandes (2016) indicate that the cost of developing e-Reporting apps for fisheries is between USD270,000 and USD2.4 million.

For specialist apps, their managers and users have to be trained in how to maintain and use the apps. For public apps, the ergonomics must ensure that users can use the app without any specific training other than an integrated tutorial. The costs for the app's operation include equipping users with a tablet, any telecommunications costs for direct downloading, and the cost of storing and archiving the data.

Based on five years' experience developing e-Reporting solutions for fisheries, the FFA estimates the total cost of an e-Reporting system at between USD2,000 and USD4,000 per vessel (Banks, Muldoon, and Fernandes 2016).

## VII INTEGRATED SYSTEMS

Currently, there is no one-size-fits-all technological solution for monitoring human activities at sea. But different technologies can be combined to make the most of each and create an image of all the sectors monitored. Several monitoring and tracking technologies are integrated in so-called "integrated" systems whose principal feature is their ability to measure, manage, analyse, extract and deliver improved information from a large volume of data.

However, these solutions are based on open data which is not subject to confidentiality or certain regulations. Integrated solutions mainly rely on AIS and commercial satellite imagery. Then on a case-by-case basis depending on their availability, VMS data and information collected by drones and unmanned surface and submarine vehicles, can also be used. This type of solution generally does not include all the available data but concentrates the information relevant to the purpose of the surveillance. The technologies and data integrated are generally:

- vessel position (AIS, VMS)
- commercial satellite imaging
- data collected by drones and unmanned surface and submarine vehicles
- environmental data.

The system's effectiveness relies on the analysis mechanisms included, such as correlating heterogeneous information (AIS and satellite imaging) and Deep Learning procedures to analyse these large volumes of data to extract the useful information. These systems can also use environmental, meteorological, etc., data to improve the information produced by the system:

- detection of vessel behaviour, such as transshipping
- calculate activity trends
- identify polluting vessels
- detect "stealth" targets (vessels having shut off their transponder).

The key component of these integrated systems is the ground segment where the results of the analysis can be viewed and consulted. Solutions are provided either by major clients (e.g., Themis solution by CLS) including software and the hardware to store and manage the data, or they can also be offered as a web application subscription (Airbus Trimaran, CLS Themis, BLUECHAM Qëhnelö and OceanMind).

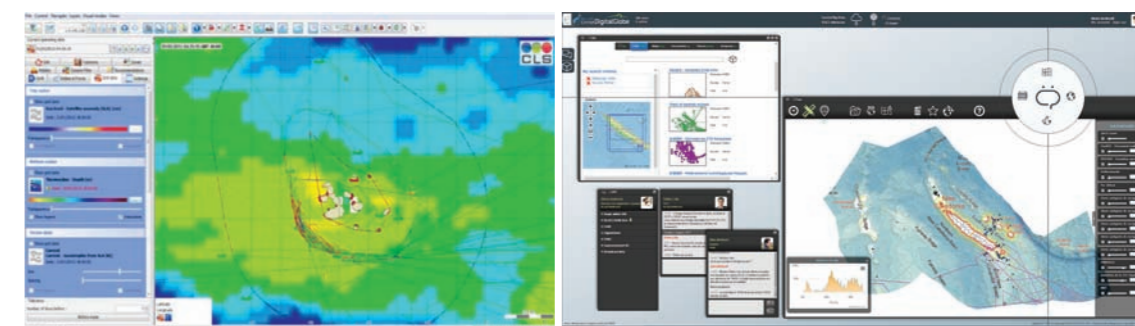

Figure 82: Left, Themis app (© CLS); right Qëhnelö web app (© BLUECHAM SAS).



# PART 3

## DECISION-AID TOOL FOR SELECTING THE MOST APPROPRIATE TECHNOLOGIES

## I INSTRUCTIONS FOR USING THE TOOL DEVELOPED FROM THE REVIEW OF SURVEILLANCE TECHNOLOGIES

The feedback from the consultation phase clearly revealed that managers need an objective tool in the form of a didactic and multicriteria catalogue. In particular, it was important for managers to be able to use this tool on their own, in their own time and based on their own internal considerations, without seeking at this stage to pre-empt needs or discussions around its use which may not be relevant as unable to include all decision-making elements.

This led us to design an interactive tool for the objective identification of optimum technological solutions in response to the selection of a certain number of surveillance criteria. This tool will be presented at a workshop organised by AFB in Noumea (New Caledonia) in July 2018.

Then, to facilitate the tool's use and its adoption by the managers, we will present case studies of situations clearly identified as including significant issues facing all or some of the four OCTs included. The tool itself with the case studies provides an integrated, objective and didactic vision liable to help managers express their needs and assist them with their decision-making.

The beta version of the tool providing a summary of technologies for monitoring and tracking activities at sea can be downloaded from the following link:

[https://www.dropbox.com/s/546aiy6o6e482ng/AFB\\_TOOL\\_ENG\\_technology\\_review\\_final\\_version\\_protected.xlsx?dl=0](https://www.dropbox.com/s/546aiy6o6e482ng/AFB_TOOL_ENG_technology_review_final_version_protected.xlsx?dl=0)

This part of the report presents various selection criteria and the practicalities. Prior to using the tool, users are encouraged to carefully read the technological review in Part 2.

This groups together the main applications and characteristics of each type of technology in the form of a parameter table. Each parameter takes into consideration the entire technology (sensor, transmission and ground segment), but summarised for users to quickly and intuitively filter the information as a function of their tracking or surveillance needs.

The tool has been designed to achieve an initial filter on the basis of five principal parameters, as they have been termed, with a certain number of operational methods associated with each parameter presented in: Table 22.

Once selected, these main criteria lead to a first list of technological solutions with their limitations to be taken into consideration. A second level of selection then introduces what we have called secondary parameters to narrow down the field of technological solutions adapted to the needs expressed through the criteria selected.

These seven secondary parameters concentrate on factors such as cost, implementation complexity, information precision and the limitations of the final product based on each technological solution (Table 23).

Users are free to explore in greater detail the technical characteristics of each technology using the hypertext links in the tool that refer back to detailed technical data sheets.

**Table 22:** Main parameters and practicalities concerning managers' needs around identifying technological solutions.

	Parameters	Description
TYPE OF INTERNET OBJECT	All vessels	Is the object of interest a vessel (all types), yes or no?
	Oceanic fishing vessel	Is the object of interest an oceanic fishing vessel, yes or no?
	Coastal or lagoon fishing vessel	Is the object of interest a coastal or lagoon fishing vessel, yes or no?
	Pleasure craft	Is the object of interest a pleasure craft, yes or no?
	Cargo or passenger vessel	Is the object of interest a cargo or passenger vessel, yes or no?
	Watercraft (surf kite, kayak, etc.)	Is the object of interest a watercraft (surf kite, kayak, va'a, jet ski), yes or no?
	Coastal or off-shore facilities	Are the objects of interest coastal or offshore facilities (oil rig, mining rig, etc.), yes or no?
	Other objects	Is the object of interest another specific floating object (pearl culture net, buoys, etc.), yes or no?
	Information collected	<ul style="list-style-type: none"> <li>• <b>Presence/absence:</b> the technology can detect the presence or absence of the specified object</li> <li>• <b>Presence/absence + behaviour:</b> the technology can detect the presence or absence of the specified object and its behaviour (movement, activity)</li> <li>• <b>Activity onboard:</b> the technology can measure activity onboard the specified object</li> </ul>
FREQUENCY AND TIMEFRAMES	Frequency of observations	Sensor observation frequency makes it possible to: <ul style="list-style-type: none"> <li>• <b>Monitor:</b> the observations are made on demand or randomly</li> <li>• <b>Track:</b> the observations are made at regular intervals or can be planned over the long term</li> <li>• <b>Track and monitor:</b> the observations are made in real time, or almost, and continuously</li> </ul>
	Operational timeframes	The operational timeframes include obtaining the measurements and the measurement transmission times: <ul style="list-style-type: none"> <li>• <b>Real time:</b> the measurements are available without any delay</li> <li>• <b>Hour:</b> the measurements are available within several hours</li> <li>• <b>Day:</b> the measurements are available within around one day</li> <li>• <b>Several days:</b> the measurements are available within several days</li> <li>• <b>Month or more:</b> the measurements are available within one month or more</li> </ul>
	Surface area	<ul style="list-style-type: none"> <li>• <b>Local:</b> the measurements cover sectors of up to 1,000 km<sup>2</sup></li> <li>• <b>Intermediate:</b> the measurements cover surface areas of several thousand km<sup>2</sup></li> <li>• <b>Global:</b> the measurements cover the entire world</li> </ul>

**Table 23:** Secondary parameters and practicalities for refining managers' identification of technological solutions.

Information precision	<p>The measurement precision is given in metres. For location readings (AIS, VMS, LRIT, surface radar), the precision corresponds to the sensor's location error. For imaging sensors, the precision corresponds to the size of the pixels. Here, the precision is directly linked to the sensor's detection/recognition and identification capacity:</p> <ul style="list-style-type: none"> <li>• ≤ 0.3 m: recognition of all types of vessels, presence/absence of people, presence/absence of buoys</li> <li>• 0.3 m to 1 m: recognition of the type of vessel</li> <li>• 1 m to 10 m: presence/absence of small boats, recognition of large vessels</li> <li>• &gt; 10 m: presence/absence of large vessels</li> </ul>
Maturity	<p>Maturity defines the entire suite of technology (sensor, transmission and ground segment):</p> <ul style="list-style-type: none"> <li>• <b>Mature:</b> the technology is operational and tried-and-tested</li> <li>• <b>Operational and under development:</b> the technology is already used operationally, some segments (sensor, transmission or ground segment) require further development to reach full and/or economic maturity</li> <li>• <b>Concept under development:</b> the technology is currently in concept or prototype phase tested on pilot units. All the technology requires development before it reaches maturity</li> </ul>
Innovation potential	<p>The innovation potential refers to the potential for improving the technology technically (improved performance) or economic (broader applications lower cost):</p> <ul style="list-style-type: none"> <li>• <b>Low:</b> the innovation potential for the suite of technology is low</li> <li>• <b>Average:</b> some of the technology's components definitely have innovation potential</li> <li>• <b>High:</b> significant components of the technology have definite innovation potential</li> </ul>
Limitations	<p>The limitations cover all the technical (sensor, transmission and ground segment) or structural (regulations and confidentiality) limitations that may cause errors in the final product:</p> <ul style="list-style-type: none"> <li>• <b>Low:</b> the technology has few limitations and the impact is confined</li> <li>• <b>Take into consideration:</b> the technology has limitations potentially causing acceptable errors in the final product</li> <li>• <b>Very high:</b> the technology has limitations potentially causing errors in the final product</li> </ul>
Cost	<p>The cost refers to the overall cost of the suite of technology including the sensor transmission mode and the ground segment facilities and is divided into three brackets:</p> <ul style="list-style-type: none"> <li>• <b>Affordable:</b> USD0 to 999,999</li> <li>• <b>Moderate:</b> USD1 to 10 million</li> <li>• <b>High investment and operational costs:</b> more than USD10 million</li> </ul>
Complexity	<p>The complexity refers to the implementation of the suite of technology (measurement acquisition, transmission and information processing). The more human involvement and resources or specific facilities are required, the more complex the technology:</p> <ul style="list-style-type: none"> <li>• <b>Low:</b> the technology is relatively simple to implement</li> <li>• <b>Moderate to complex:</b> some of the technology's components may be complex to implement</li> <li>• <b>Very complex:</b> all the technology requires qualified staff and/or specific facilities</li> </ul>
Archived data available	<p>Answer yes or no whether historic measurements by the same type of sensor are available and accessible. The availability of archives may be of significant benefit in assessing the evolution of certain activities, etc.</p>







# REFERENCES

- Aerosonde & AAI Textron Systems** (2014) "Aerosonde UAS Maritime Surveillance Capabilities" presented at the MCS Emerging Technologies Workshop, Honiara, Solomon Islands.
- AFB** (2017) Données clefs sur la protection des récifs coralliens de l'Outre mer français - Polynésie Française, 30p.
- Anderson E, Judson B, Tu'itupou S, Thaman B** (2003) Marine Pollution Risk Assessment for the Pacific Islands Region (PACPOL Project Ra1), Secretariat of the Pacific Regional Environment Program.
- Andréfouët S, Chagnaud N, Chauvin C, Kranenburg CJ** (2008) Atlas des récifs coralliens de France Outre-Mer, Centre IRD de Nouméa, 153 p.
- Andreoli R, Kinne P, Lille D** (2017) "The Monitoring of Maritime Incident Using Remote Sensing and Cloud Solution" presented at the The Pacific GIS&RS User Conference, Suva, Fiji.
- Anonyme** (2015) Stratégie nationale de sûreté des espaces maritimes. Comité interministériel de la mer du 22 octobre 2015, 58p.
- Baghdadi N, Mehrez Z** (2016a) Observation Des Surfaces Continentales Par Télédétection Optique.
- Baghdadi N, Mehrez Z** (2016b) Observation Des Surfaces Continentales Par Télédétection Micro-Onde.
- Ball H** (2013) Satellite AIS For Dummies®, Special Edition. John Wiley & Sons Canada Ltd.
- Banks R, Muldoon G, Fernandes V** (2016) Analysis of the Costs and Benefits of Electronic Fisheries Information Systems Applied in FFA Countries and Identification of the Legislative, Regulatory and Policy Supporting Requirements. Final Report 1155-WWF/FFA. Poseidon Aquatic Resource Management Ltd.
- Bartholome W, David C, Mangel JC, Alfaro-Shigueto J, Pingo S, Jimenez A, Godley BJ** (2018) Remote Electronic Monitoring as a Potential Alternative to On-Board Observers in Small-Scale Fisheries. *Biological Conservation* 219: 35–45.
- Batty M, Adams T** (2014) "Electronic Monitoring Programs" presented at the MCS Emerging Technologies Workshop, Honiara, Solomon Islands.
- Bell JD, Kronen M, Vunisea A, Nash WJ, Keeble G, Demmke A, Andréfouët S** (2009). Planning the use of fish for food security in the Pacific. *Marine Policy* 33(1): 64-76.
- Blondy C** (2011) La croisière dans l'espace polynésien: jeux de lieux et d'acteurs, pratiques, aménagements et enjeux de développement. *Études caribéennes*: 18 [online]
- Brugneaux S, Lagouy E, Alloncle N, Gabrié C** (2010) Analyse éco-régionale marine de Polynésie Française. CRISP. Composante 1 Projet 1A1: Planification de la conservation de la biodiversité marine. 138p.
- Bryson M, Williams S** (2015) Review of Unmanned Aerial Systems (UAS) for Marine Surveys. Australian Centre for Field Robotics, University of Sydney.
- Chen Y** (2014) Satellite-Based AIS and Its Comparison with LRIT. *TransNav, the International Journal on Marine Navigation and Safety of Sea Transportation* 8 (2): 183–187.
- Churchyard T, Eaton MA, Havery S** (2016) The biodiversity of the United Kingdom's Overseas Territories: a stock take of species occurrence and assessment of key knowledge gaps. *Biodivers Conserv* 25: 1677.
- Conservation News** (2017) Tuna Catch Monitoring Enters the Electronic Age. <https://news.mongabay.com/wildtech/2017/07/tuna-catch-monitoring-enters-the-electronic-age/>.
- Couchat P** (2018) "STRADIVARIUS HF Surface Wave Radar BLUECHAM – Revue Technologique Pour l'AFB 18 Mars 2018." Documentation technique.
- D'Angelo P, Gellért M, Reinartz P** (2016) Skybox Image and Video Product Evaluation. *International Journal of Image and Data Fusion* 7 (1): 3–18.
- De Miguel Molina B, Marival SO** (2018) The Drone Sector in Europe. *Ethics and Civil Drones*, edited by María de Miguel Molina and Virginia Santamarina Campos, 7–33.
- DigitalGlobe** (2016) "Digitalglobe Satellite and Product Overview" Presented at the JACIE Workshop, Tokyo, Japan, November 6.
- Dujardin B** (2004) L'AIS1 et ses capacités de surveillance maritime. *La revue maritime*, no. 467: 5.
- Dupouy C, Andreoli R, Wattelez G, Pinazo C, Fuchs R, Mangeas M** (2014) Les Satellites Auscultent La Couleur de l'océan Applications En Nouvelle-Calédonie. Conférence Découvertes presented at the Conférence Découvertes, IRD, Nouméa.
- European Commission & JRC** (2008) Integrated Maritime Policy for the EU. Working Document. Maritime Surveillance Systems.
- ExactEarth** (2014) "Integrated Satellite Monitoring Technologies." presented at the MCS Emerging Technologies Workshop, Honiara, Solomon Islands.
- FAO** (1997) Review of the State of World Fishery Resources: Marine Fisheries, FAO Fisheries Circular No. 920 FIRM/C920.
- Fastwave** (2014) "Ocean Sensors" presented at the MCS Emerging Technologies Workshop, Honiara, Solomon Islands.
- Fastwave** (2015) "Unmanned Maritime Systems." Submission to Australia's Defence White Paper.
- FIMS & iFIMS** (2014) "Integrated Fisheries Information Management System (IFIMS)." presented at the MCS Emerging Technologies Workshop, Honiara, Solomon Islands.
- Fisheries Forum Agency** (2018) Type Approval of Units Used with VMS and Authorised Installers | Pacific Islands Forum Fisheries Agency (FFA).
- Fournier M** (2012) L'apport de l'imagerie satellitale à la surveillance maritime. Contribution géographique et géopolitique. Phd thesis, Université Paul Valéry - Montpellier III.
- Friedlander AM, Wagner D, Gaymer CF, T'Aulani W, Nai'AL, Brooke S, Kikiloi K, Ole V** (2016) Co-operation between large-scale MPAs: successful experiences from the Pacific Ocean. *Aquatic Conservation: Marine and Freshwater Ecosystems* 26(S2): 126-141.
- Gillett R** (2016) Fisheries in the Economies of Pacific Island Countries and Territories. Secretariat of the Pacific Community, Noumea, 664 pages.
- Gonson C, Pelletier D, Gamp E, Preuss B, Jollit I, Ferraris J** (2016) Decadal increase in the number of recreational users is concentrated in no-take marine reserves. *Marine pollution bulletin*, 107(1): 144-154.
- Govan H** (2017) Ocean Governance – Our Sea of Islands' in Katafono, R.(ed.), *A Sustainable Future for Small States: Pacific 2050* (forthcoming), Commonwealth Secretariat, London.
- Graham P** (2016) "Basic Costs of MCS Operations" Presented at the MCS Emerging Technologies Workshop, Auckland, New Zealand.
- Guyonnet J** (2016) Déploiement d'un Drone Maritime Autonome, Le Wave Glider. Rapport de stage de 3<sup>e</sup> année. Réseaux et Télécommunication. Université de Toulon - SeaTech.
- Hosken M, Vilia H, Agi J, Williams P, Mckechnie S, Mallet D, Honiwala E** (2014) Report on the 2014 Solomon Islands Longline E-Monitoring Project. Sol. Is. E-Monitoring Project - 2014. SPC, ISSF, SatLink, FFA Devfish II.
- Hwang JN** (2016) "Automated Image/Video Analyses for Fishery Science" Presented at the MCS Emerging Technologies Workshop, Auckland, New Zealand.
- Ilčev SD** (2018) Stratospheric Platform Systems (SPSs). In *Global Mobile Satellite Communications Applications*, by Stojce Dimov Ilcev, 561–621.
- International Convention for the Safety of Life at Sea** (1974).
- Irving R, Dawson T** (2013) Coral Reefs of the Pitcairn Islands. In: Sheppard C, Ed. *Coral Reefs of the United Kingdom Overseas Territories*. Netherlands: Springer Netherlands. pp. 299–318.

- Kelleher K** (2002) "Institutional Options for VMS" Presented at the Sub-Regional VMS Workshop, Saly, Sénégal, October 14.
- Kinch J, Anderson P, Richards E, Talouli A, Vieux C, Peteru C, Suaesi T** (2010) Outlook report on the state of the marine biodiversity in the Pacific Islands region. Secretariat of the Pacific Regional Environment Programme, Apia.
- Lawery LO, Howse G, Mastracci M, Heyl PJ, Cho M** (2016) Fisheries Surveillance Aerial Patrol Study: Feasibility, Costs, and Benefits. Fisheries Surveillance Aerial Patrol Study. Momentum Aerospace Group (MAG).
- Le Tixerant M** (2004) Dynamique des activités humaines en mer côtière. Application à la Mer d'Iroise (Doctoral dissertation, Université de Bretagne occidentale-Brest).
- Léopold M, Dumas P** (2009). Propositions pour limiter l'impact de l'ancrage des navires de tourisme sur les récifs coralliens en Nouvelle-Calédonie. Etude des sites d'OUVEA et de LIFOU (îles Loyauté). UR 128, Rapport IRD/IFRECOR. 25 p
- Liquid Robotics** (2017a) The Wave Glider SV3 V200 Platform Specifications. Specification Sheet.
- Liquid Robotics** (2017b) Monitoring Marine Protected Areas. Liquid Robotics Case Study.
- Liquid Robotics** (2018) Wave Glider BGAN Options Specifications.
- Loubersac L, Galletout JF, Péré M** (2018) Etude préliminaire Technico Commerciale d'un projet d'implantation d'une station de réception de données satellites d'observation de la Terre de moyenne à très haute résolution optiques et/ou radar en Nouvelle-Calédonie. Rapport de consultance. Nouméa: Océan Avenir NC & Mea Intuis Sarl.
- Lurton X** (1998) Acoustique sous-marine. Présentation et applications. Editions IFREMER.
- Maguer AR, Grati DA, Stoner R, Guerrini P, Troiano L, Alvarez A** (2013) Ocean Gliders Payloads for Persistent Maritime Surveillance and Monitoring. In 2013 OCEANS - San Diego, 1-8.
- Mallalieu KI, Kevon A** (2014) "Low-Cost Fisheries MCS Tools." presented at the 4th Global Fisheries Enforcement Training Workshop (GFETW), San Jose, Costa Rica, February 17.
- Manley JE** (2008) Unmanned Surface Vehicles, 15 Years of Development. In OCEANS 2008, 1-4.
- Maresca S, Braca P, Horstmann J, Grasso R** (2014) Maritime Surveillance Using Multiple High-Frequency Surface-Wave Radars. IEEE Transactions on Geoscience and Remote Sensing 52 (8): 5056-5071.
- Masika S** (2016) "Overview of Current Application of MCS Technology." presented at the MCS Emerging Technologies Workshop, Auckland, New Zealand.
- McElderry H** (2016) "Electronic Monitoring Opportunities for Commercial Fisheries." presented at the MCS Emerging Technologies Workshop, Auckland, New Zealand.
- Middleton D, Trident Systems** (2016) "The Magic of Collaboration - Video Observation in New Zealand Led by Fisheries Science and Benefitting All." presented at the MCS Emerging Technologies Workshop, Auckland, New Zealand.
- Munro N** (2016) "Observer Services, Electronic Monitoring." presented at the MCS Emerging Technologies Workshop, Auckland, New Zealand.
- Nott BJ** (2015) "Long-Endurance Maritime Surveillance With Ocean Glider Networks." Master's Thesis, Monterey, California: Naval Postgraduate School.
- O'Leary BC, Ban NC, Fernandez M, Friedlander AM, García-Borboroglu P, Golbuu Y, Guidetti P** (2018) Addressing Criticisms of Large-Scale Marine Protected Areas. BioScience (2018).
- Oates M** (2016) "Fisheries Information Management System (FIMS) ECDS." presented at the MCS Emerging Technologies Workshop, Auckland, New Zealand.
- ORBCOMM** (2010) "Worldwide AIS Data From Space - Ppt Download." presented at the Worldwide AIS Data from Space, Texas, USA.
- OMI** (2013) Convention de l'Organisation Maritime Internationale SOLAS.
- Pelletier D, Bockel T, Carpentier L, Schohn T, Raillard B, Powell A** (2016) Evaluation de l'impact de l'activité de croisière sur l'habitat et les peuplements de poissons de la Baie d'Easo-Xepenehe, Lifou. Campagne STAVIRO 2014. Rapport AMBIO/A/30.
- Polidoro BA, Elfes CT, Sanciangco JC, Pippard H, Carpenter KE** (2011) Conservation Status of Marine Biodiversity in Oceania: An Analysis of Marine Species on the IUCN Red List of Threatened Species. Journal of Marine Biology: article ID 247030.
- PROE** (2015) Cadre pour la conservation de la nature et les aires protégées dans la région du Pacifique insulaire 2014-2020 - Apia, Samoa
- Règlement (CE) n° 2244/2003 de la Commission du 18 décembre 2003 établissant les modalités d'application du système de surveillance des navires par satellite.** 2003. OJ L. Vol. 333.
- Robards MD, Silber GK, Adams JD, Arroyo J, Lorenzini D, Schwehr K, Amos J** (2016) Conservation Science and Policy Applications of the Marine Vessel Automatic Identification System (AIS) - a Review. Bulletin of Marine Science 92 (1): 75-103.
- Selbe S** (2014) Monitoring and Surveillance Technologies for Fisheries. Waitt Institute.
- Serry A, Lévêque L** (2015) Le système d'identification automatique (AIS). Une source de données pour étudier la circulation maritime. Netcom. Réseaux, communication et territoires, (29-1/2), 177-202.
- Smith P** (2016) "A Survey of Advances in MCS & Related Applications of UAS." presented at the MCS Emerging Technologies Workshop, Auckland, New Zealand.
- SPC** (2016) ER and EM: From trials to implementation. SPC Oceanic Fisheries Programme - Presentation at IOTC 20/23 may 2016- La Reunion
- SPC** (2017) The e-volution of fisheries monitoring: The implementation of e-reporting and e-monitoring tools in longline and purse seine fisheries. SPC Fisheries Newsletter #153 - May-August 201
- SPREP** (2015) Pacific Ocean Pollution Prevention Programme (PACPOL): Strategy and Work Plans 2015-2020. - Apia, Samoa: SPREP, 2015. 60 p.
- Steele A** (2016) "Sustainable Fishing Technology Solutions." presented at the MCS Emerging Technologies Workshop, Auckland, New Zealand.
- Suhendar M** (2013) "Comparison of Vessel Monitoring System (VMS) Between Iceland and Indonesia," UNU - Fisheries Training Programme, Final Project: 29.
- Tournadre J** (2014) Anthropogenic pressure on the open ocean: The growth of ship traffic revealed by altimeter data analysis. Geophysical Research Letters, Vol. 41, No. 22, pp. 7924-7932.
- Vandel E, Grellier M, Joannot P** (2016) TIT Biodiversité DES RÉCIFS CORALLIENS EN OUTRE-MER BILAN 2008-2015. Documentation Ifremer.
- Verdone M, Seidl A** (2012) Fishing and Tourism in the Fijian Economy. Gland, Switzerland: IUCN.
- Ward-Paige CA** (2017) A global overview of shark sanctuary regulations and their impact on shark fisheries. Marine Policy, 82, 87-97.
- World Bank** (2016) Tourism. Pacific Possible Background papers. <http://www.worldbank.org/en/country/pacificislands/brief/pacific-possible>
- Zorn JB** (2013) "A Systems Engineering Analysis of Unmanned Maritime Systems for U.S. Coast Guard Missions." Master's Thesis, Monterey, California: Naval Postgraduate School.



# APPENDIX

## List of stakeholders contacted and response.

Country/Territory	Institution/Organisation	Contact type	Response
New Caledonia	Government of New Caledonia, Department of Industry, Mining and Energy (DIMENC)	Questionnaire	YES
New Caledonia	Government of New Caledonia, Department of Maritimes Affairs (DAM)	Questionnaire	YES
New Caledonia	Government of New Caledonia, Department of Infrastructure, Topography and Land Transport (DITTT)	Questionnaire	YES
New Caledonia	Government of New Caledonia, Regional Customs Administration (DRD)	Questionnaire	NO
New Caledonia	Autonomous Ports of New Caledonia	Questionnaire	NO
New Caledonia	Loyalty Islands Province, Department of Economic Integration (DEI)	Questionnaire	NO
New Caledonia	Loyalty Islands Province, Department of Sustainable Development and Applied Research (DDDRA)	Questionnaire	YES
New Caledonia	North Province, Development, Economy and Environment Department (DDEE)	Questionnaire	YES
New Caledonia	South Province, Department of the Environment (DENV)	Questionnaire	YES
New Caledonia	South Province, Department of Rural Development (DDR)	Questionnaire	YES
Pitcairn	Government of Pitcairn Islands, Conservation & Natural Resources Division	Questionnaire	YES
Pitcairn	Pitcairn Islands Office (PIO)	Questionnaire	NO
French Polynesia	Department of the Environment (DIREN)	Questionnaire	NO
French Polynesia	Department of Marine and Mineral Resources (DRMM)	Questionnaire	YES
French Polynesia	French Polynesia Department of Maritimes Affairs (DPAM)	Questionnaire	NO
French Polynesia	Regional Customs Administration	Questionnaire	NO
French Polynesia	Papeete Autonomous Port	Questionnaire	NO
Wallis and Futuna	Agriculture, Forestry and Fisheries Department	Questionnaire	YES
Wallis and Futuna	Environment Department	Questionnaire	YES
Wallis and Futuna	Maritime Affairs, Ports, Lighthouses and Beacons Department	Questionnaire	NO
Wallis and Futuna	Wallis and Futuna Customs Authority	Questionnaire	NO
New Caledonia	State Action at Sea (AEM)	Request for information	YES
New Caledonia	French Agency for Biodiversity (AFB)	Request for information	YES
New Caledonia	Maritime Cluster of New Caledonia (CMNC)	Request for information	YES
New Caledonia	Conservation International (CI)	Request for information	NO
New Caledonia	Natural Areas Conservancy (CEN)	Request for information	NO
New Caledonia	Government of New Caledonia, Regional Cooperation and External Relations Department	Request for information	YES

Country/Territory	Institution/Organisation	Contact type	Response
New Caledonia	High Commission of the Republic in New Caledonia	Request for information	NO
New Caledonia	Institute of Research and Development (IRD)	Request for information	NO
New Caledonia	Private consultant in charge of SRD study	Request for information	YES
New Caledonia	Pacific Community (SPC), Coastal Fisheries	Request for information	YES
New Caledonia	Pacific Community (SPC), MCS	Request for information	YES
New Caledonia	Pacific Community (SPC), Oceanic Fisheries	Request for information	YES
New Caledonia	Pacific Community (SPC), Climate Change and Environmental Sustainability	Request for information	NO
New Caledonia	The Pew Charitable Trust - Global Ocean Legacy	Request for information	YES
New Caledonia	World Wide Fund for Nature (WWF)	Request for information	YES
French Polynesia	State Action at Sea (AEM)	Request for information	YES
French Polynesia	French Agency for Biodiversity (AFB)	Request for information	YES
French Polynesia	Maritime Cluster of French Polynesia (CMPF)	Request for information	NO
French Polynesia	High Commission of the Republic in French Polynesia	Request for information	NO
French Polynesia	Ministry of Culture and the Environment	Request for information	NO
French Polynesia	Ministry for the Development of Primary Resources, Land, Public Domain and Mines	Request for information	NO
French Polynesia	Office of the President of French Polynesia	Request for information	NO
French Polynesia	The Pew Charitable Trust - Global Ocean Legacy	Request for information	YES
French Polynesia	International Union for Conservation of Nature (IUCN)	Request for information	NO
Samoa	Secretariat of the Pacific Regional Environment Programme (SPREP)	Request for information	YES
Solomon Islands	Forum Fisheries Agency (FFA)	Request for information	NO
Cook Islands	Office of the Prime Minister	Request for information	YES
Fiji	Secretariat of the Pacific Community (SPC), GeoScience Division	Request for information	NO
Fiji	Wildlife Conservation Society (WCS)	Request for information	YES
Australia	Australian Government, Department of Home Affairs, Pacific and Transnational Issues Branch	Request for information	NO
New Zealand	British Consulate-General in Auckland	Request for information	NO
New Zealand	Conservation International (CI)	Request for information	NO
New Zealand	World Wide Fund for Nature (WWF)	Request for information	YES
France	International Union for Conservation of Nature (IUCN)	Request for information	NO



Photo: Christine Bourgeois (Cedille)

## The Pacific Biodiversity Blue Belt project

Launched in May 2016, this project is implemented by the Secretariat of the Pacific Regional Environment Programme (SPREP) in partnership with the French Agency for Biodiversity (AFB). It benefited from a BEST 2.0 medium-scale grant from the European Union. Its purpose is to provide assistance to the Overseas Countries and Territories (OCT) in the Pacific (French Polynesia, New Caledonia, Wallis & Futuna and the Pitcairn Islands) for integrated management of the ocean and biodiversity conservation, and in their efforts to achieve the Aichi marine Biodiversity Targets 6, 10 and 11. The project also ties in with the “Pacific Oceanscape Vision” and the “Framework for Pacific Regionalism”, both of which have been adopted by all the South Pacific island States and Territories.

Photo: Christine Bourgois (Cédille)

**AGENCE FRANÇAISE  
POUR LA BIODIVERSITÉ**  
ÉTABLISSEMENT PUBLIC DE L'ÉTAT

