

Pacific Country Report

Sea Level & Climate: *Their Present State*

Solomon Islands

June 2006

Disclaimer

The views expressed in this publication are those of the authors and not necessarily those of the Australian Agency for International Development (AusAID).

**PACIFIC COUNTRY REPORT
ON
SEA LEVEL & CLIMATE: THEIR PRESENT STATE**



SOLOMON ISLANDS

June 2006

Executive Summary

- A SEAFRAME gauge was installed in Honiara, Solomon Islands, in July 1994. It records sea level, air and water temperature, atmospheric pressure, wind speed and direction. It is one of an array designed to monitor changes in sea level and climate in the Pacific.
- This report summarises the findings to date, and places them in a regional and historical context.
- The sea level trend to date is +6.8 mm/year but the magnitude of the trend continues to vary widely from month to month as the data set grows. Accounting for the precise levelling results and inverted barometric pressure effect, the trend is +6.7 mm/year. A nearby gauge, with longer records but less precision and datum control, shows a trend of -5.65 mm/year.
- Variations in monthly mean sea level include a moderate seasonal cycle and were affected by the 1997/1998 El Niño.
- Variations in monthly mean air and water temperature are likewise affected by the 1997/1998 El Niño.
- Since installation, no tropical cyclone has passed near enough to the Honiara gauge to have caused extreme low barometric pressure. In December 2002 an intense tropical cyclone struck the southern islands of Anuta and Tikopia.
- The SEAFRAME gauge at Honiara, Solomon Islands has not recorded any tsunami since installation, but historically tsunamis have been observed in Solomon Islands.

Contents

	Page
Executive Summary	2
1. Introduction	4
2. Regional Overview	5
2.1. Regional Climate and Oceanography	5
2.2. Sea level datasets from SEAFRAME stations	8
2.2.1. Vertical datum control of SEAFRAME sensors	10
2.2.2. Inverted barometric pressure effect	12
2.2.3. Combined net rate of relative sea level trends	13
2.3. Sea level datasets from additional stations	14
2.4. Satellite altimetry	17
3. Project Findings to Date – Solomon Islands	19
3.1. Extreme events	19
3.1.1. Tropical cyclones	19
3.1.2. Tsunamis	19
3.2. SEAFRAME sea level record and trend	21
3.3. Additional sea level records and trend	23
3.4. Predicted highest astronomical tide	25
3.5. Monthly mean air temperature, water temperature, and atmospheric pressure	26
3.6. Precise Levelling Results for Solomon Islands	29
Appendix	
A.1. Definition of Datum and other Geodetic Levels at Honiara, Solomon Islands	30

1. Introduction

As part of the AusAID-sponsored South Pacific Sea Level and Climate Monitoring Project ("Pacific Project") for the FORUM region, in response to concerns raised by its member countries over the potential impacts of an enhanced Greenhouse Effect on climate and sea levels in the South Pacific region, a **SEAFRAME (Sea Level Fine Resolution Acoustic Measuring Equipment)** gauge was installed in Honiara, Solomon Islands in July 1994. The gauge has been returning high resolution, good scientific quality data since installation.

SEAFRAME gauges not only measure sea level by two independent means, but also a number of "ancillary" variables - air and water temperatures, wind speed, wind direction and atmospheric pressure. There is an associated programme of levelling to first order, to determine shifts in the vertical of the sea level sensors due to local land movement. A Continuous Global Positioning System (CGPS) station will be installed in Solomon Islands to determine the vertical movement of the land with respect to the International Terrestrial Reference Frame.

When change in sea level is measured with a tide gauge over a number of years one cannot be sure whether the sea is rising or the land is sinking. Tide gauges measure relative sea level change, i.e., the change in sea level relative to the tide gauge, which is connected to the land. To local people, the relative sea level change is of paramount importance. Vertical movement of the land can have a number of causes, e.g. island uplift, compaction of sediment or withdrawal of ground water. From the standpoint of global change it is imperative to establish absolute sea level change, i.e. sea level referenced to the centre of the Earth, which is to say in the terrestrial reference frame. In order to accomplish this, the rate at which the land moves must be measured separately. This is the reason for the addition of CGPS near the tide gauges.

2. Regional Overview

2.1. Regional Climate and Oceanography

Variations in sea level and atmosphere are inextricably linked. For example, to understand why the sea level at Tuvalu undergoes a much larger annual fluctuation than at Samoa, we must study the seasonal shifts of the trade winds. On the other hand, the climate of the Pacific Island region is entirely ocean-dependent. When the warm waters of the western equatorial Pacific flow east during El Niño, the rainfall, in a sense, goes with them, leaving the islands in the west in drought.

Compared to higher latitudes, air temperatures in the tropics vary little throughout the year. Of the SEAFRAME sites, those furthest from the equator naturally experience the most extreme changes – the Cook Islands (at 21°S) recorded the lowest temperature, 13.1°C, in August 1998. The Cook Islands regularly fall to 16°C while Tonga (also at 21°S) regularly falls to 18°C in winter (July/August).

Table 1. Range in air temperatures observed at SEAFRAME stations

SEAFRAME location	Minimum recorded air temperature (°C)	Maximum recorded air temperature (°C)
Cook Islands	13.1	32.0
Tonga	16.0	31.4
Fiji (Lautoka)	16.6	33.4
Vanuatu	16.5	33.3
Samoa	18.7	32.3
Tuvalu	22.8	33.7
Kiribati	22.4	32.9
Nauru	22.4	33.0
Solomon Islands	20.1	34.5
Papua New Guinea	21.5	31.8
Marshall Islands	22.0	31.9
FSM	23.0	31.8

The most striking oceanic and climate fluctuations in the equatorial region are not the seasonal, but interannual changes associated with El Niño. These affect virtually every aspect of the system, including sea level, winds, precipitation, and air and water temperature. Referring to Figure 1, we see that at most SEAFRAME sites, the lowest recorded sea levels appear during the 1997/1998 El Niño. The most dramatic effects were observed at the Marshall Islands, PNG, Nauru, Tuvalu and Kiribati, and along a band extending southeastward from PNG to Samoa. The latter band corresponds to a zone meteorologists call the “South Pacific Convergence Zone” or SPCZ (sometimes called the “Sub-Tropical Convergence Zone”, or STCZ).

Figure 1. Sea level anomalies* at SEAFRAME sites

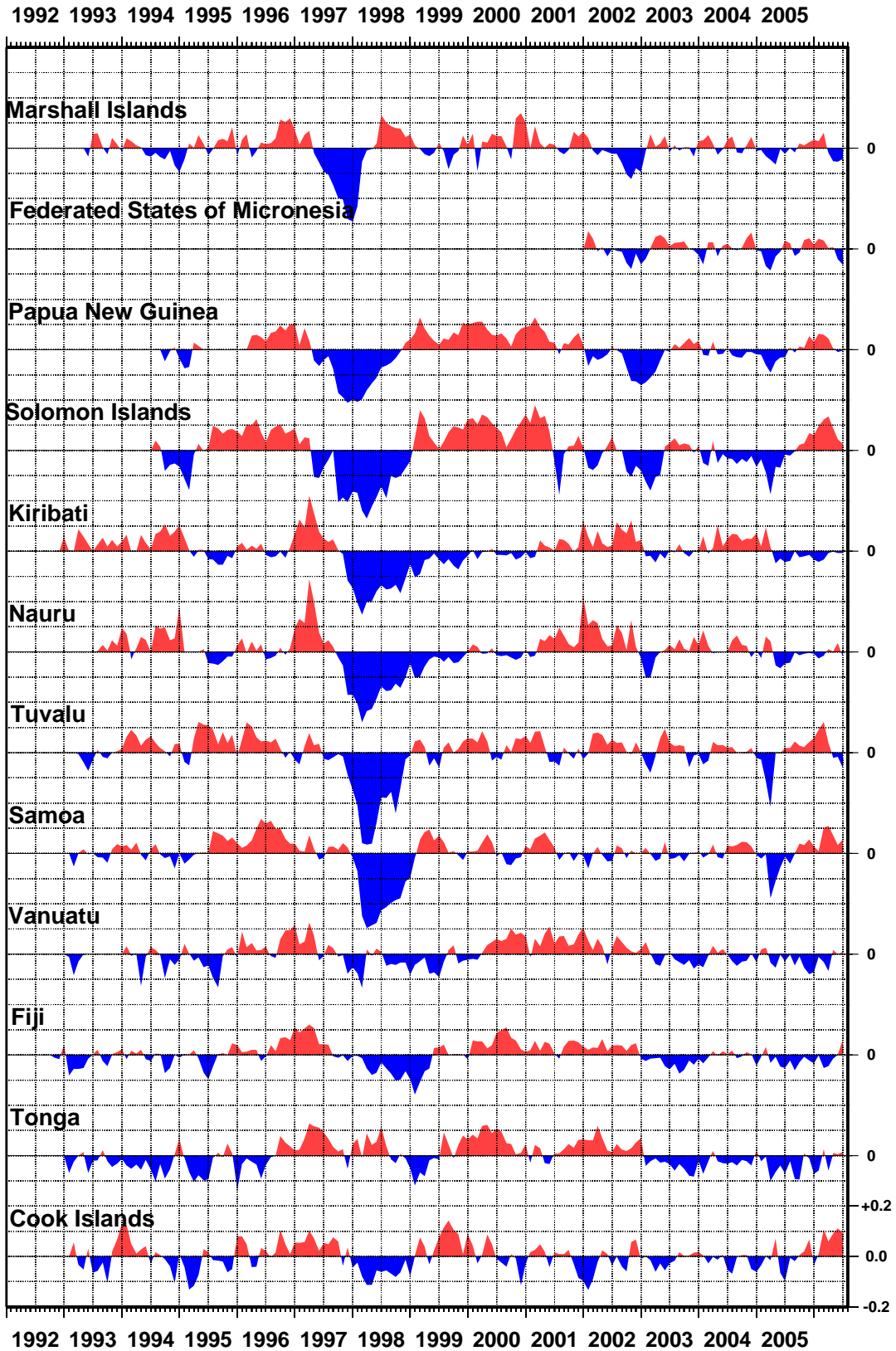

* Sea level “anomalies” have had tides, seasonal cycles and trend removed from the sea level observations.

Most Pacific Islanders are very aware that the sea level is controlled by many factors, some periodic (like the tides), some brief but violent (like cyclones), and some prolonged (like El Niño), because of the direct effect the changes have upon their lives. The effects vary widely across the region. Along the Melanesian archipelago, from Manus Island to Vanuatu, tides are predominantly diurnal, or once daily, while elsewhere the tide tends to have two highs and two lows each day. Cyclones, which are fueled by heat stored in the upper ocean, tend to occur in the hottest month. They do not occur within 5° of the equator due to the weakness of the “Coriolis Force”, a rather subtle effect of the earth’s rotation. El Niño’s impact on sea level is mostly felt along the SPCZ, because of changes in the strength and position of the Trade Winds, which have a direct bearing on sea level, and along the equator, due to related changes in ocean currents. Outside these regions, sea levels are influenced by El Niño, but to a far lesser degree.

Figure 2. Mean surface water temperature

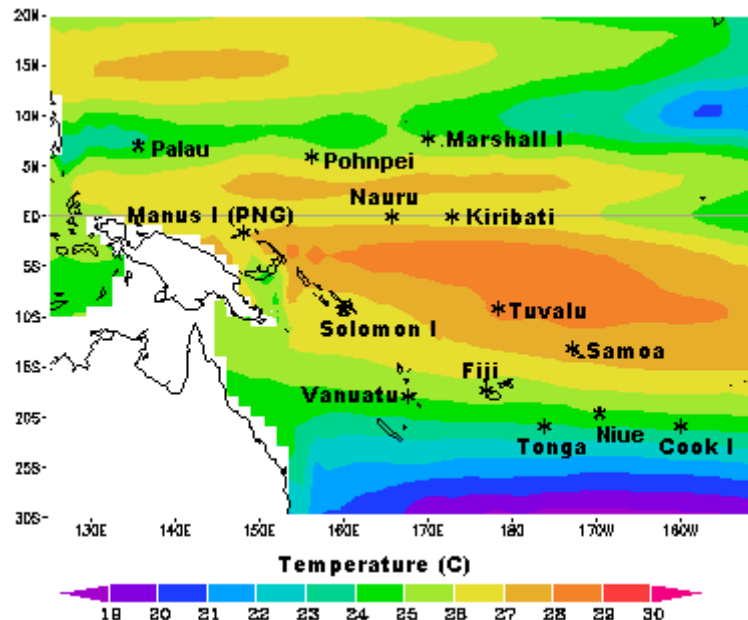

Note the warm temperatures in the SPCZ and just north of the equator.

The convergence of the Trade Winds along the SPCZ has the effect of deepening the warm upper layer of the ocean, which affects the seasonal sea level. Tuvalu, which is in the heart of the SPCZ, normally experiences higher-than-average sea levels early each year when this effect is at its peak. At Samoa, the convergence is weaker, and the seasonal variation of sea level is far less, despite the fact that the water temperature recorded by the gauge varies in a similar fashion. The interaction of wind, solar heating of the oceanic upper layer, and sea level, is quite complex and frequently leads to unexpected consequences.

The Streamlines of Mean Surface Wind (Figure 3) shows how the region is dominated by easterly trade winds. In the Southern Hemisphere the Trades blow to the northwest and in the Northern Hemisphere they blow to the southwest. The streamlines converge, or crowd together, along the SPCZ.

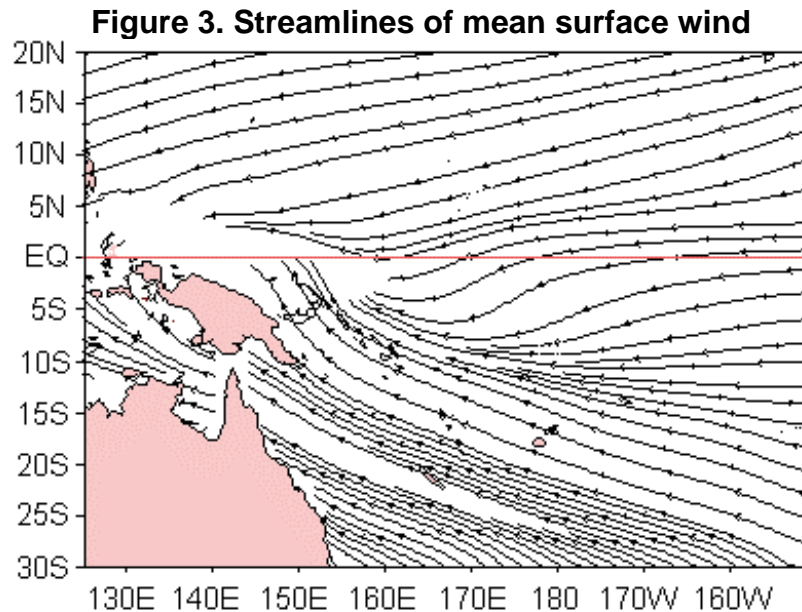

Much of the Melanesian subregion is also influenced by the Southeast Asian Monsoon. The strength and timing varies considerably, but at Manus Island (PNG), for example, the NW monsoon season (winds from the northwest) runs from November to March, while the SE monsoon brings wind (also known as the Southeast Trade Winds) from May to October. Unlike many monsoon-dominated areas, the rainfall at Manus Island is distributed evenly throughout the year (in normal years).

2.2. Sea Level Datasets from SEAFRAME stations

A key objective of the South Pacific Sea Level and Climate Monitoring Project (SPSLCMP) is to provide an accurate long-term sea level record. SEAFRAME stations were installed from 1992 onwards to provide precise relative sea level measurements. The SEAFRAMES undergo regular calibration and maintenance and are levelled against a network of land-based benchmarks to maintain vertical datum control. The SEAFRAME observations are transmitted hourly via satellite and are processed using specific quality control procedures.

The project's data collection program has been operating for a relatively short term and so the sea level trends are still prone to the effects of shorter-term ocean variability (such as El Niño and decadal oscillations). As the data sets increase in length, the trend estimates will begin to reflect longer-term change rather than short-term fluctuations. Figure 4 shows how the sea level trends from SEAFRAME stations have evolved from one year after installation to the present. These trends will continue to stabilise for many more years, as is demonstrated by Figure 5.

2.2.1 Vertical datum control of SEAFRAME sensors

Precise levelling of the height of the SEAFRAME sea level sensor relative to an array of land-based benchmarks is undertaken periodically, preferably every eighteen months. The precision to which the survey must be performed is dependent on the distance K_m (km) between the SEAFRAME sensor benchmark and the primary tide gauge benchmark (TGBM) and forms part of the project's design specifications.

The precise levelling program enables the vertical stability of the SEAFRAMES to be monitored. Registering the sea levels to land is especially important if the SEAFRAME needs to be replaced or relocated or is displaced by a boat or a storm. The rates of vertical movement of the gauges relative to the TGBM (determined by fitting a straight line to the survey results) that are contributing to observed sea level trends are listed in Table 2. Substantial subsidence of the tide gauge at Samoa is occurring at a rate of -1.1 mm/year. Subsidence is also occurring at Marshall Islands and Solomon Islands. The tide gauges at Cook Islands, Fiji, and Vanuatu are rising at 0.3 mm/year with respect to the tide gauge benchmark. The rates of vertical tide gauge movement are used to correct observed rates of relative sea level change.

Table 2. Distance (km), required survey precision (mm), number of surveys and the rate of vertical movement of the SEAFRAME relative to the TGBM.

Location	K_m (km)	$\pm 2 \sqrt{K_m}$ (mm)	Number of Surveys	Vertical movement (mm/year)
Cook Is	0.491	1.4	8	+0.3
FSM	0.115	0.7	2	N/A
Fiji	0.522	1.4	8	+0.3
Kiribati	0.835	1.8	9	+0.1
Marshall Is	0.327	1.1	8	-0.5
Nauru	0.120	0.7	9	+0.0
PNG	0.474	1.4	7	-0.2
Samoa	0.519	1.4	8	-1.1
Solomon Is	0.394	1.3	4	-0.4
Tonga	0.456	1.4	8	-0.1
Tuvalu	0.592	1.5	8	-0.1
Vanuatu	1.557	2.5	7	+0.3

Continuous Geographical Positioning Systems (CGPS) stations have also been installed on most of the islands where SEAFRAME gauges are located (Table 3). The purpose of the CGPS program is to close the final link in establishing vertical datum control – that is, to determine whether the island or coastal region as a whole is moving vertically with respect to the International Terrestrial Reference Frame. Early estimates of the rates of vertical movement are supplied in Table 3 but continued monitoring is necessary before meaningful results emerge from the CGPS time series data. The latest CGPS information for the project is available from Geosciences Australia at

<http://www.ga.gov.au/geodesy/slm/spslcmp/>

Table 3. Status of CGPS installations and results to June 30, 2005*

Location	Date of Installation	Trend in Height Component* (mm/year)	Uncertainty (mm/year)
Cook Is	10 September 2001	-2.1	0.6
FSM	1 May 2003	6.0	2.1
Fiji	25 November 2001	2.9	0.7
Kiribati	4 August 2002	0.0	1.1
Marshall Is	Not yet installed		
Nauru	30 June 2003	7.8	2.3
PNG	1 May 2002	5.3	0.9
Samoa	1 July 2001	-0.3	0.5
Solomon Is	Not yet installed		
Tonga	18 February 2002	1.8	0.8
Tuvalu	2 December 2001	-0.2	0.7
Vanuatu	11 September 2002	1.7	0.9
Palau	Not yet installed		
Niue	Not yet installed		

***Note of Caution:**

'It is important to note that the length of the time series is too short for reliable vertical station velocity estimation. As the data collection and the height time series becomes longer, and the strategy of simultaneous estimation of velocities and periodical or seasonal signals is used, the estimates of the vertical crustal motion will become more accurate and reliable.'

South Pacific Sea Level and Climate Monitoring GPS Coordinate Time Series.

Geosciences Australia Online Report

http://www.ga.gov.au/image_cache/GA6732.pdf

2.2.2. Inverted barometric pressure effect

Another parameter that influences the estimates of relative sea level rise is atmospheric pressure. Known as the inverted barometer effect, if a 1 hPa fall in barometric pressure is sustained over a day or more, a 1 cm rise is produced in the local sea level (within the area beneath the low pressure system). Therefore, if there are trends in the barometric pressure recorded at the tide gauge sites, there will be a contribution to the observed relative sea level trends. The contribution will be a 10 mm/year increase (decrease) in relative sea levels for a 1 hPa/year decrease (increase) in barometric pressure.

Estimates of the contribution to relative sea level trends by the inverted barometric pressure effect at all SEAFRAME sites over the period of the project are listed in Table 4. The estimates are mostly positive, which means relative sea level trends are overestimated without taking the barometric pressure effect into consideration. An inverse barometer correction can be applied to observed rates of relative sea level change.

Table 4. Recent short-term barometric pressure trends expressed as equivalent sea level rise in mm/year based upon SEAFRAME data to June 2006.

Location	Installed	Barometric Pressure Contribution to Sea Level Trend (mm/yr)
Cook Is	19/02/1993	0.3
FSM	17/12/2001	-0.5
Fiji	23/10/1992	1.1
Kiribati	02/12/1992	0.5
Marshall Is	07/05/1993	0.3
Nauru	07/07/1993	0.6
PNG	28/09/1994	1.7
Samoa	26/02/1993	0.4
Solomon Is	28/07/1994	-0.3
Tonga	21/01/1993	0.9
Tuvalu	02/03/1993	0.6
Vanuatu	15/01/1993	1.2

*The trend at FSM is from a comparatively short series and therefore varies considerably.

2.2.3. Combined net rate of relative sea level trends

The effects of the vertical movement of the tide gauge platform and the inverse barometer effect are removed from the observed rates of relative sea level change and presented in Table 5. These net rates are spatially coherent (with the exception of FSM and Tonga) and consistent with regional sea level trends observed from satellite altimeters over a similar timeframe. The net sea level trend at FSM is comparatively large because it is derived from a comparatively short record. The net sea level trend at Tonga is large in comparison to its neighbouring sites (Cook Islands and Fiji), which could possibly be due to vertical motion of the whole island, but the CGPS record there is still too short (since February 2002) for this motion to be reliably quantified.

Table 5. The net relative sea level trend estimates as at June 2006 after the inverted barometric pressure effect and vertical movements in the observing platform are taken into account.

Location	Installed	Sea Level Trend (mm/yr)	Barometric Pressure Contribution (mm/yr)	Vertical Tide Gauge Movement Contribution* (mm/yr)	Net Sea Level Trend (mm/yr)
Cook Is	19/02/1993	2.5	0.3	-0.3	2.5
FSM**	17/12/2001	21.4	-0.5	N/A	20.9
Fiji	23/10/1992	2.5	1.1	-0.3	1.7
Kiribati	02/12/1992	5.7	0.5	-0.1	5.3
Marshall Is	07/05/1993	5.2	0.3	+0.5	4.4
Nauru	07/07/1993	7.1	0.6	-0.0	6.5
PNG	28/09/1994	8.1	1.7	+0.2	6.2
Samoa	26/02/1993	6.9	0.4	+1.1	5.4
Solomon Is	28/07/1994	6.8	-0.3	+0.4	6.7
Tonga	21/01/1993	8.0	0.9	+0.1	7.0
Tuvalu	02/03/1993	6.4	0.6	+0.1	5.7
Vanuatu	15/01/1993	3.1	1.2	-0.3	2.2

*The contribution is the inverse rate of vertical tide gauge movement

** The sea level trend at FSM is derived from a comparatively short data record.

2.3. Sea Level Datasets from Additional Stations

Additional sea level data sets for the Pacific Forum Region are available from the Joint Archive for Sea Level (JASL). This archive was established in 1987 to supplement the University of Hawaii Sea Level Centre data holdings with contributions from other agencies. The research quality datasets available from the JASL may be accessed online at <http://uhslc.soest.hawaii.edu/uhsclc/jasl.html>

Sea level in the Pacific Forum region undergoes large inter-annual and decadal variations due to dynamic oceanographic and climatic effects such as El Niño. Such variability or 'noise' affects estimates of the underlying long-term trend. In general, more precise sea level trend estimates are obtained from longer sea level records as is shown in Figure 5. Sea level records of less than 25 years are thought to be too short for obtaining reliable sea level trend estimates. A confidence interval or precision of 1 mm/year should be obtainable at most stations with 50-60 years of data on average, providing there is no acceleration in sea level change, vertical motion of the tide gauge, or abrupt shifts in trend due to tectonic events.

Figure 5. 95% Confidence Intervals for linear mean sea level trends (mm/year) plotted as a function of the year range of data. Based on NOAA tide gauges with at least 25 years of record¹.

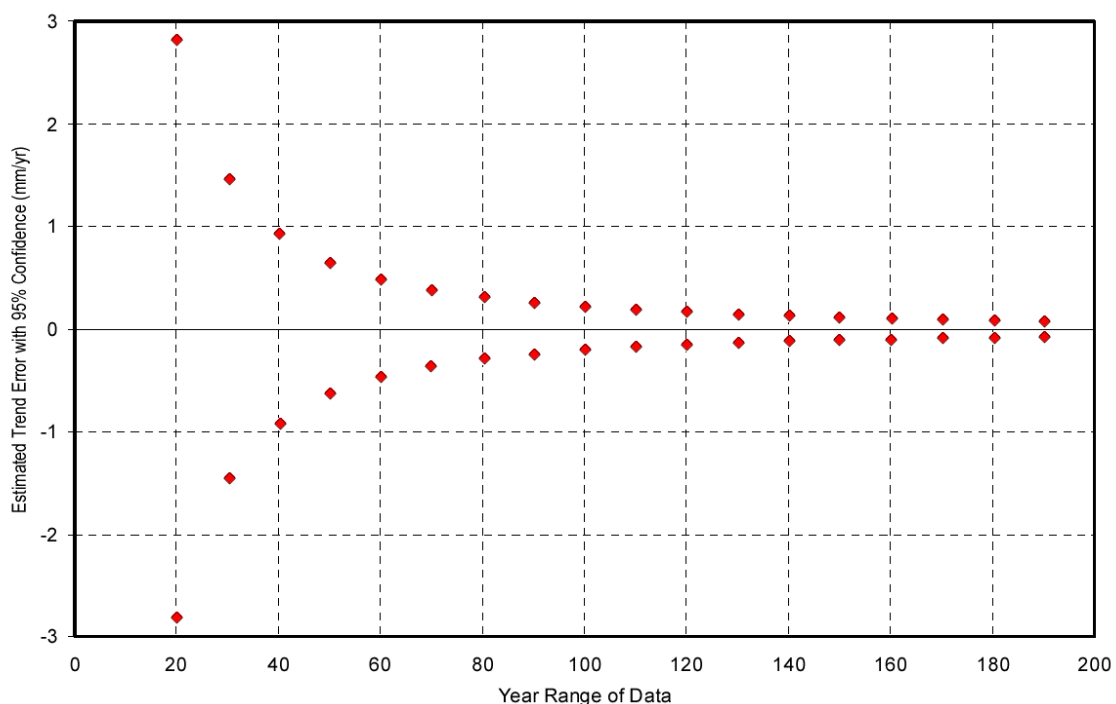

The annual mean sea levels and relative sea level trends for additional JASL sea level data sets are shown in Figure 6. The datasets are of different lengths covering different periods of time and climatic and sea level change. Many of the datasets are too short to provide reliable trend estimates. At some stations there are multiple sea level records, but joining them together can be problematic. They are archived

1. Zervas, C. (2001) Sea Level Variations of the United States 1854-1999. NOAA, USA.

separately on the Joint Archive for Sea Level because they either originate from different tide gauge locations or they have unrelated tide gauge datum.

Diverse climatic and oceanographic environments are found within the Pacific Islands region. Different rates of vertical land movement are likely at different stations. Many of the historical tide gauges were designed to monitor tides and sea level variability caused by El Niño and shorter-term oceanic fluctuations rather than long-term sea level change and lack the required level of instrumental precision and vertical datum control. All of these factors potentially affect the rates of relative sea level change that are listed in Table 6. The overall mean trend from stations with more than 25 years of data is 1.14 mm/year.

Table 6. Sea level trends for Pacific Forum Stations on the Joint Archive for Sea Level Data Holdings as at March 2006.

JASL	STATION	COUNTRY	START DATE	END DATE	SPAN (years)	TREND (mm/yr)
001a	Pohnpei-A	Fd St Micronesia	1-Jan-1969	31-Dec-1971	3	116.3
001b	Pohnpei-B	Fd St Micronesia	1-Jan-1974	31-Dec-2004	31	1.78
002a	Tarawa-A, Betio	Rep. of Kiribati	1-Jan-1974	31-Dec-1983	10	-5.26
002b	Tarawa-B, Bairiki	Rep. of Kiribati	1-Jan-1983	31-Dec-1988	6	29.76
002c	Tarawa-C, Betio	Rep. of Kiribati	1-Jan-1988	31-Dec-1997	10	3.27
004a	Nauru-A	Rep. of Nauru	1-Jan-1974	31-Dec-1995	22	-0.42
005a	Majuro-A	Rep. Marshall I.	1-Jan-1968	31-Dec-1999	32	2.31
006a	Enewetok-A	Rep. Marshall I.	1-Jan-1951	31-Dec-1971	21	1.29
006b	Enewetok-B	Rep. Marshall I.	1-Jan-1974	31-Dec-1979	6	-10.03
007a	Malakal-A	Rep. of Belau	1-Jan-1926	31-Dec-1939	14	-6.27
007b	Malakal-B	Rep. of Belau	1-Jan-1969	31-Dec-2003	35	0.84
008a	Yap-A	Fd St Micronesia	1-Jan-1951	31-Dec-1952	2	37.26
008b	Yap-B	Fd St Micronesia	1-Jan-1969	31-Dec-2004	36	-0.42
009a	Honiara-A	Solomon Islands	1-Jan-1974	31-Dec-1995	22	-5.65
010a	Rabaul	Papua New Guinea	1-Jan-1966	31-Dec-1997	32	-2.21
011a	Christmas-A	Rep. of Kiribati	1-Jan-1955	31-Dec-1972	18	-3.78
011b	Christmas-B	Rep. of Kiribati	1-Jan-1974	31-Dec-2003	30	0.8
012a	Fanning-A	Rep. of Kiribati	1-Jan-1957	31-Dec-1958	2	-21.67
012b	Fanning-B	Rep. of Kiribati	1-Jan-1972	31-Dec-1987	16	1.84
012c	Fanning-C	Rep. of Kiribati	1-Jan-1988	31-Dec-1990	3	118.86
013a	Kanton-A	Rep. of Kiribati	1-Jan-1949	31-Dec-1967	19	3.15
013b	Kanton-B	Rep. of Kiribati	1-Jan-1972	31-Dec-2001	30	-0.43
018a	Suva-A	Fiji	1-Jan-1972	31-Dec-1997	26	4.67
023a	Rarotonga-A	Cook Islands	1-Jan-1977	31-Dec-1997	21	4.34
024a	Penrhyn	Cook Islands	1-Jan-1977	31-Dec-2003	27	1.69
025a	Funafuti-A	Tuvalu	1-Jan-1977	31-Dec-1999	23	0.92
029a	Kapingamarangi	Fd St Micronesia	1-Jan-1978	31-Dec-2003	26	1.46
046a	Port Vila-A	Vanuatu	1-Jan-1977	31-Dec-1982	6	13.55
053a	Guam	USA Trust	1-Jan-1948	31-Dec-2004	57	0.61
054a	Truk	Fd St Micronesia	1-Jan-1963	31-Dec-1991	29	1.79
055a	Kwajalein	Rep. Marshall I.	1-Jan-1946	31-Dec-2004	59	1.2
056a	Pago Pago	USA Trust	1-Jan-1948	31-Dec-2004	57	1.85

The mean trend for datasets that span more than 25 years (bold font) is 1.14 mm/yr.
Data from JASL as at March 2006

Figure 6. Annual mean sea levels and linear sea level trends (mm/year) for additional stations on the Joint Archive for Sea Level.

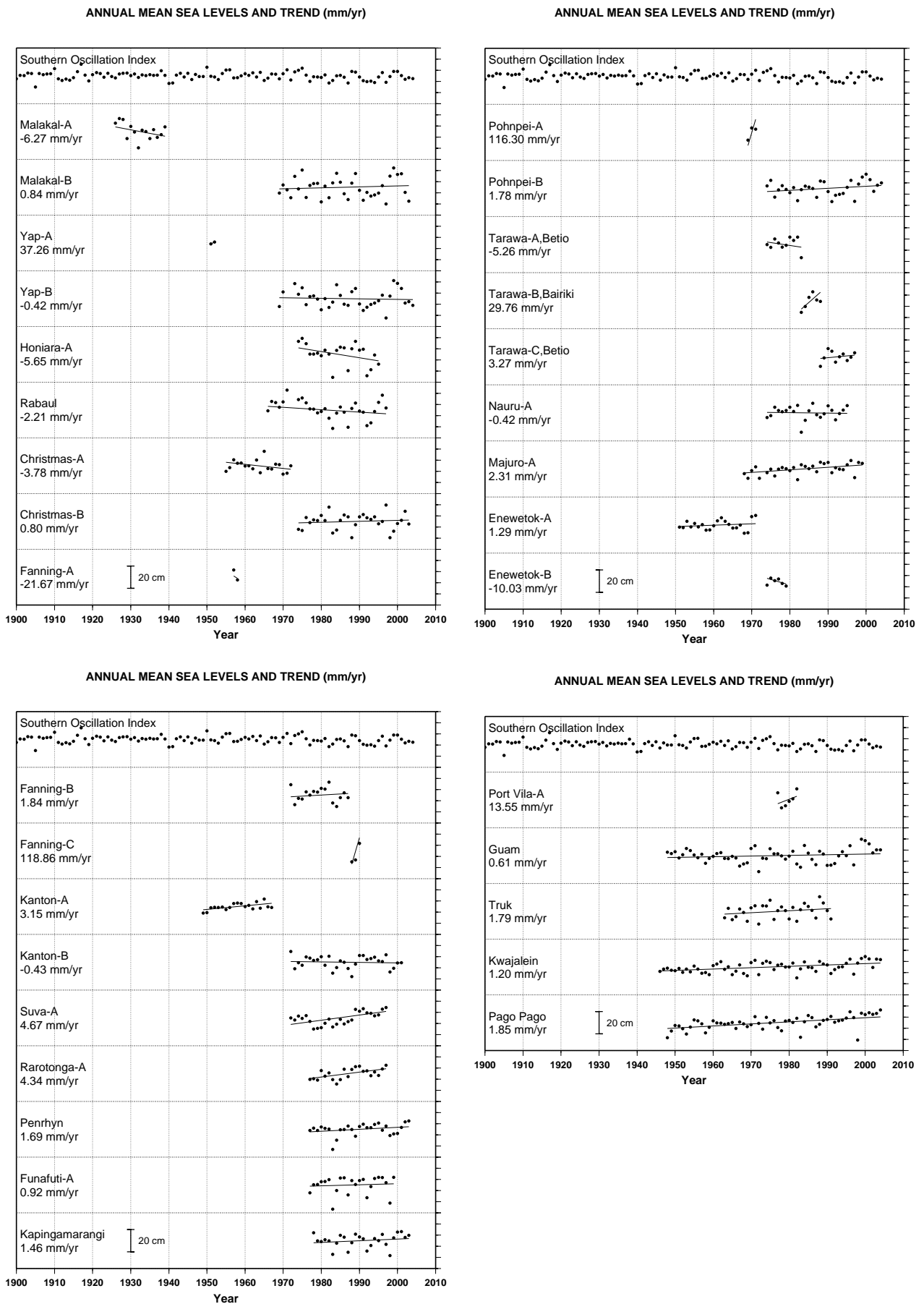

2.4. Satellite Altimetry

Satellite altimetry is technology that allows the height of the sea surface to be measured from satellites orbiting the earth. Satellites altimeters such as Topex/Poseidon and the follow-up mission Jason1 have provided a global record of sea level beginning in late 1992. Although the time interval between successive sea level measurements of the same position on earth is 10 days, the spatial coverage is particularly useful for mapping sea surface anomalies and monitoring development of basin scale events such as El Niño.

Satellite altimeters have an accuracy of several centimetres in the deep ocean, but are known to be inaccurate in shallow coastal regions. As such they cannot replace in-situ tide gauges. Tide gauges are needed to calibrate the satellite altimeters and provide accurate and more frequent sea level measurements in specific locations where reliable tide predictions and real time monitoring of extreme sea levels is of prime importance.

Information about global sea level change derived from satellite altimeters is available from the University of Colorado at <http://sealevel.colorado.edu/>. Sea level data collected by Topex/Poseidon and Jason show that global mean sea level has risen at a rate of 2.9 ± 0.4 mm/yr since late 1992 (Figure 7).

Figure 7. Global Mean Sea Level Change Measured By Satellite Altimeters between Dec 1993 and Aug 2005. (Figure Courtesy Of University Of Colorado)

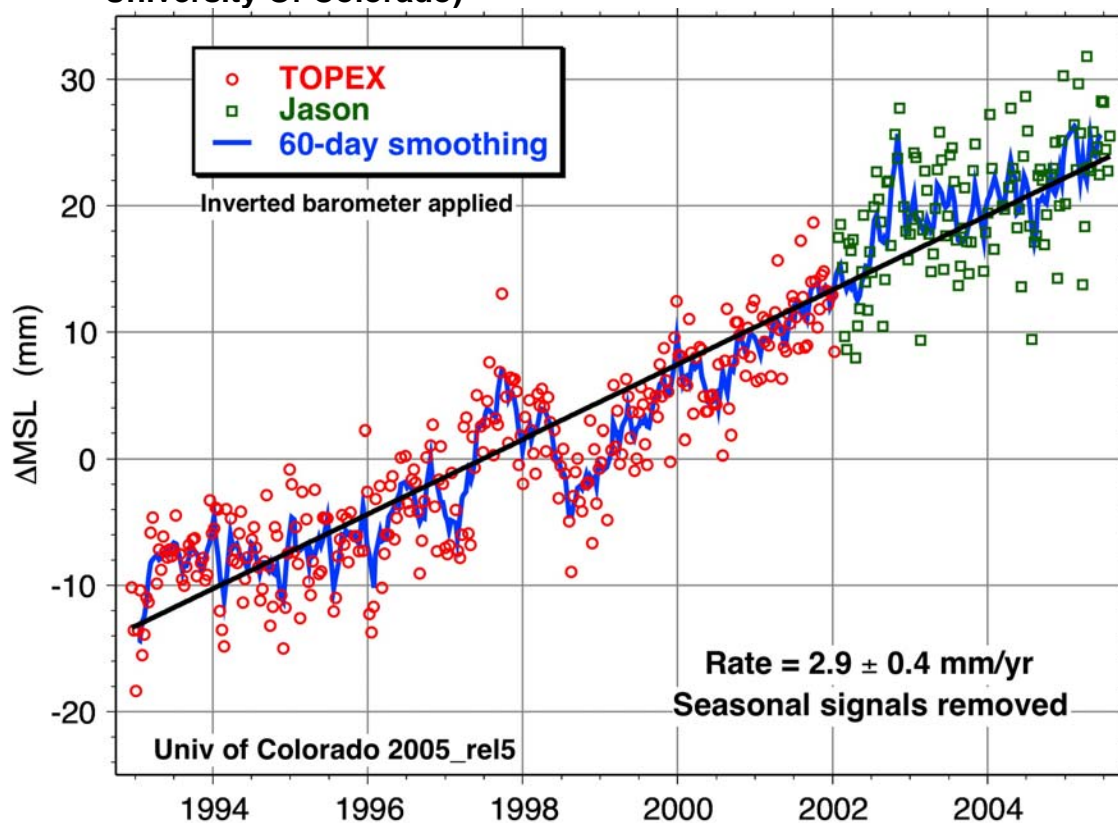

However global mean sea level change during this time has not been geographically uniform and continued monitoring is necessary (Figure 8). For example, sea level has risen at higher rates in the southwest Pacific region and has fallen in the northwest Pacific due to a basin-wide decadal 'slosh' in the Pacific Ocean. The satellite altimetry data has a similar length of record to the South Pacific Sea Level Monitoring Project SEAFRAME stations. The sea level trends from SEAFRAME stations (Table 5) are mostly higher than the global average rate shown in Figure 7, but this is consistent with the map of regional sea level trends shown in Figure 8.

Figure 8. Regional Rates of Sea Level Change from December 1992 to Aug 2005 as measured by satellite altimeters. (Figure courtesy of University of Colorado)

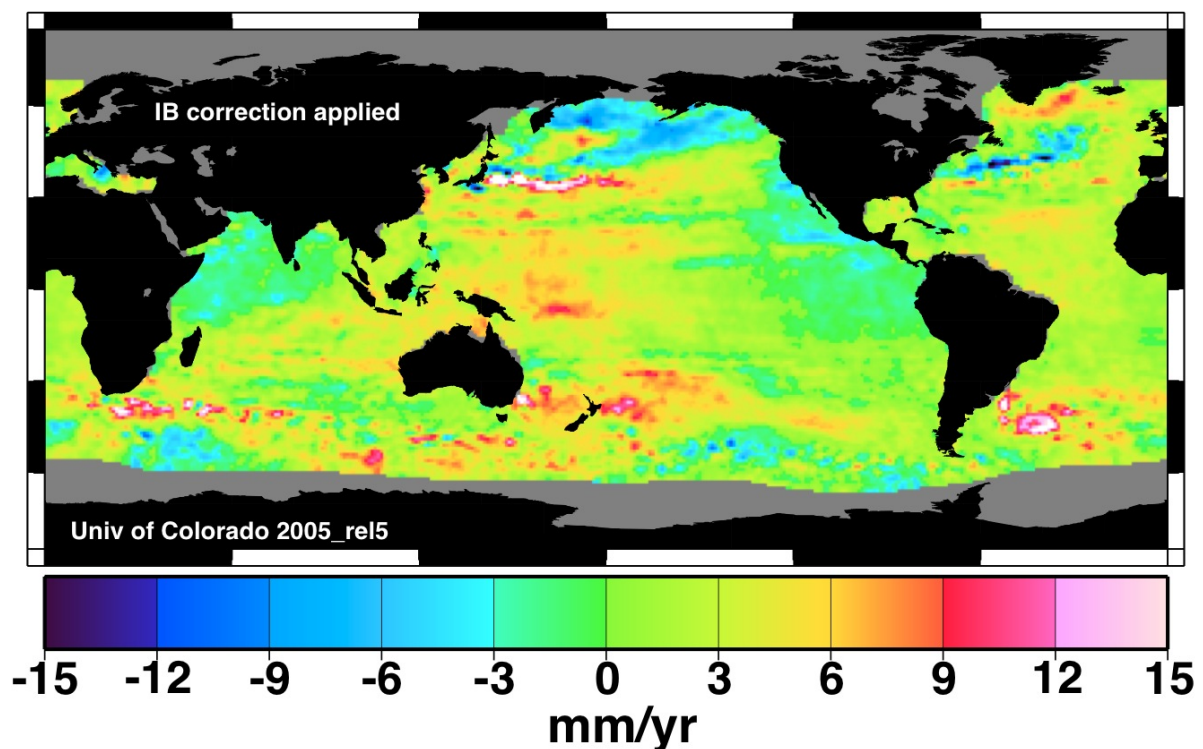

This section has provided an overview of aspects of the climate and sea level of the South Pacific Sea Level and Climate Monitoring Project region as a whole. The following section provides further details of project findings to date that are relevant to Solomon Islands.

3. Project findings to date - Solomon Islands

3.1. Extreme Events

3.1.1. Tropical Cyclones

A number of Tropical Cyclones have passed near the Solomon Islands since the SEAFRAME was installed, but none have come close enough to Honiara to be recorded as very low pressures. In late December 2002, TC Zoe struck the small islands of Anuta and Tikopia, causing major damage but no loss of life. Zoe was one of the strongest tropical cyclones since the advent of satellite tracking.

3.1.2. Tsunamis

A tsunami is a series of waves generated by an impulsive disturbance such as an undersea earthquake, coastal or submarine landslide, volcanic eruption, or asteroid impact. Tsunamis are most commonly generated along tectonic plate margins where earthquakes and volcanoes are found. Due to their association with seismic events tsunamis are also referred to as *seismic sea waves*. The term *tidal wave* is incorrect, as tsunamis have nothing to do with tide generating forces. Tsunami waves may be barely discernible in the open ocean but as they propagate into shallow coastal waters their size may increase significantly.

Figure 9 shows the sources of historical tsunami events listed in the *Integrated Tsunami Database for the Pacific and the Eastern Indian Ocean*¹. A number of tsunamis have been generated in the South Pacific Sea Level and Climate Monitoring Project region. The SEAFRAME tide gauge network has an important role in real time tsunami monitoring and contributes toward the tsunami warning system for the Pacific Ocean.

The historical record reveals that tsunamis have been observed in Solomon Islands from sources including Solomon Islands, Solomon Sea, Bismarck Sea, Papua New Guinea, Irian Jaya, Russia, Mexico and Chile. Figure 10 shows the inverse tsunami travel time chart for Honiara, Solomon Islands. This chart may be used to provide an estimate of the time taken for a tsunami to arrive at Honiara from any source location.

¹ ITDB/PAC (2004) Integrated Tsunami Database for the Pacific, Version 5.12 of December 31, 2004. CD-ROM, Tsunami Laboratory, ICMMG SD RAS, Novosibirsk, Russia.

Figure 9. Historical Tsunami Events in the Pacific and Eastern Indian Ocean. Circle size indicates earthquake magnitude and colour indicates tsunami intensity.

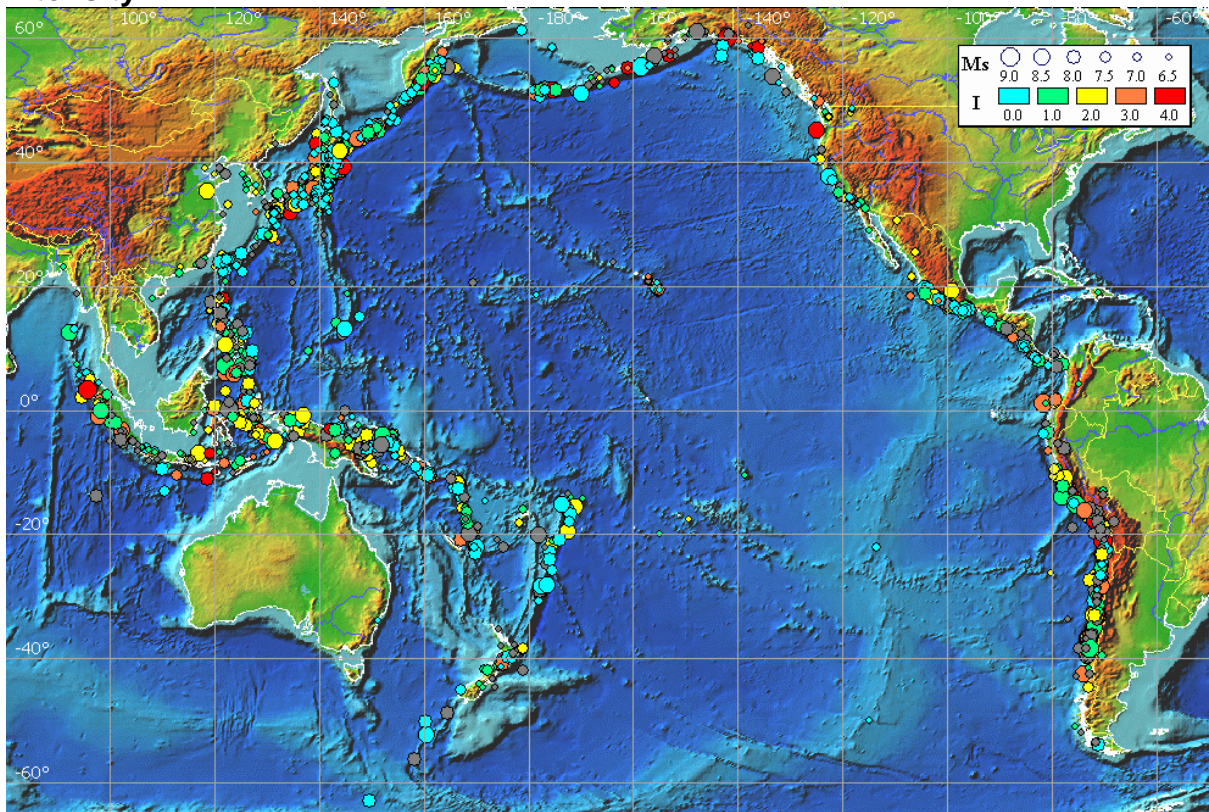
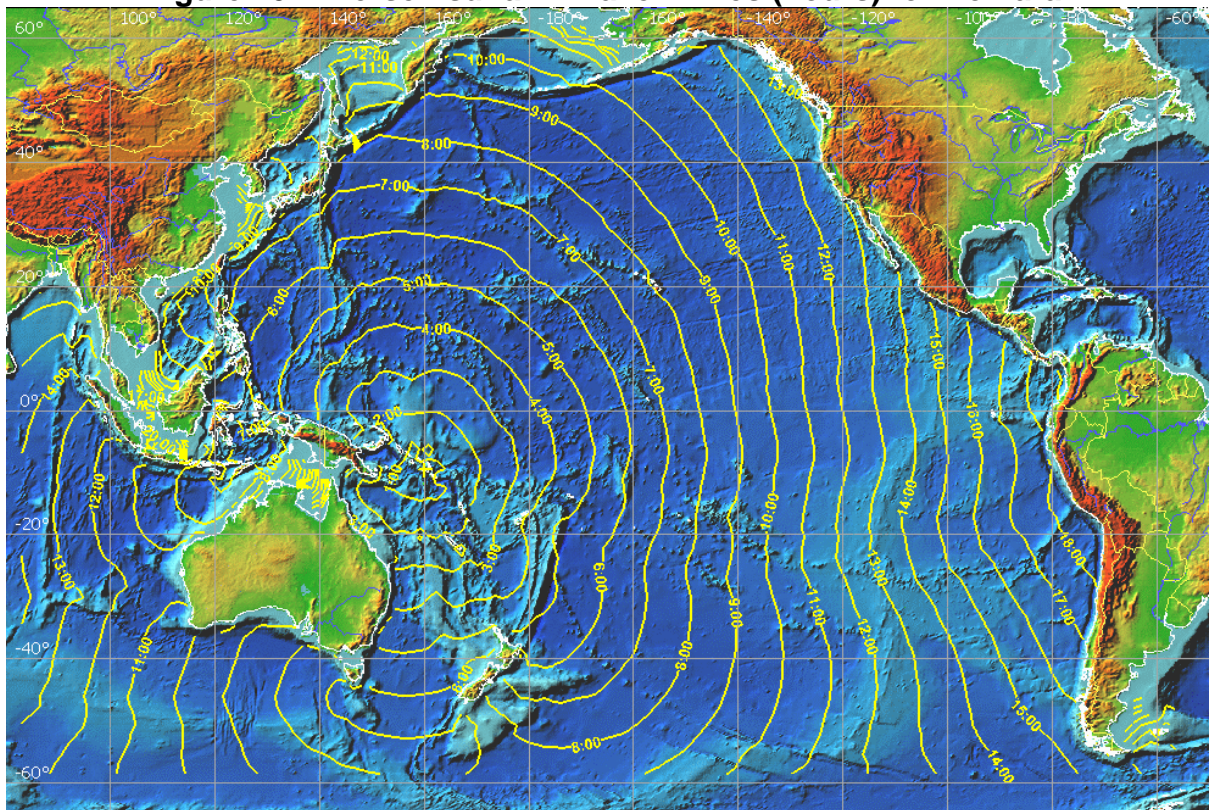

Figure 10. Inverse Tsunami Travel Times (hours) for Honiara.



3.2. SEAFRAME sea level record and trend

A fundamental goal of the Project is to establish the rate of sea level change. It has been recognised since the beginning that this would require several decades of continuous, high quality data. The preliminary findings are being provided, but caution should be exercised in interpreting this information. Figure 5 shows that confidence in trend estimates improve as more data becomes available.

As at June 2006, based on the short-term sea level rise analyses performed by the National Tidal Centre using the Honiara SEAFRAME data, a rate of **+6.8 mm per year** has been observed. Accounting for the inverted barometric pressure effect and vertical movements in the observing platform, the net sea level trend is **+6.7 mm per year**. By comparison, the Intergovernmental Panel on Climate Change (IPCC) in its Third Assessment Report (IPCC TAR, 2001) estimates that global average long-term sea level rise over the last hundred years was of the order of 1 to 2 mm/yr.

Figure 4 shows how the trend estimate has varied over time. In the early years, the trend appeared to indicate an enormous rate of sea level rise. Later, due to the 1997/1998 El Niño when sea level fell 29 cm below average, the trend actually went negative, and remained so for the next two years. Given the sea level record is relatively short, it is still too early to deduce a long-term trend.

The sea level data recorded since installation is summarised in Figure 11. The middle curve (green) represents the monthly mean sea level. The upper and lower curves show the highest and lowest values recorded each month. Like many of the SEAFRAME sites, sea level at Honiara experienced a dramatic decrease in 1998 as a result of El Niño. Honiara is relatively close to the equator, where El Niño signals are most pronounced.

By inspection of the monthly maxima (red curve) it appears that the Solomon Islands, like Fiji, the Cook Islands, Tonga and Tuvalu, experiences highest sea levels near the start of the year. At mid-year, the highest sea levels are typically about 10-20 cm less than when at the maximum. However, this pattern does not occur every year, and the seasonal cycle is particularly disrupted during the El Niño. The mean sea level over the duration of the record is 0.66 metres, with a maximum of 1.32 metres in April 2006, and a minimum of -0.07 metres in July 2001.

Figure 11

Monthly sea level at Honiara
SEAFRAME gauge

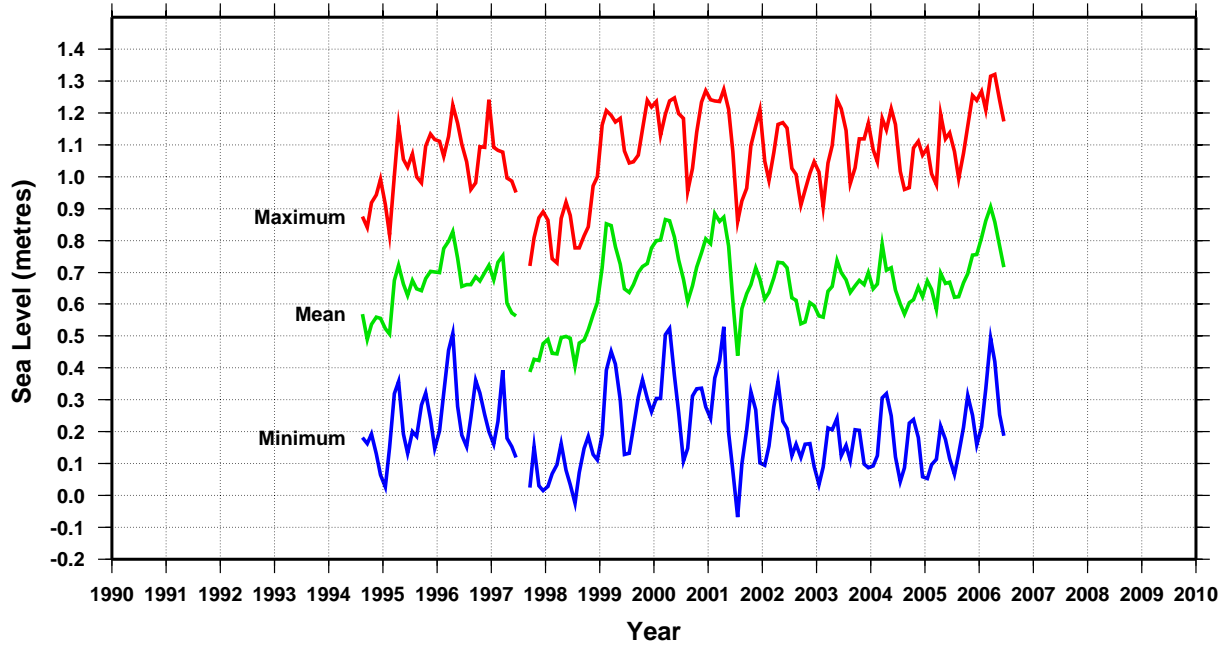

3.3. Additional sea level records and trend

An additional 22-year sea level record for Honiara, Solomon Islands is available from the Joint Archive for Sea Level. The monthly sea level data are shown in Figure 13 and contains a relative sea level trend of -5.65 mm/year. Older tide gauge installations were primarily designed for monitoring tides and shorter-term oceanic fluctuations such as El Niño rather than long-term sea level monitoring which requires a high level of precision and datum control. Hence, even with 22 years of data, the trend cannot be established without sizeable uncertainties.

Figure 12



Figure 13

Monthly sea level at Honiara-A
Joint Archive For Sea Level Data
Sea Level Trend: -5.6 mm/yr

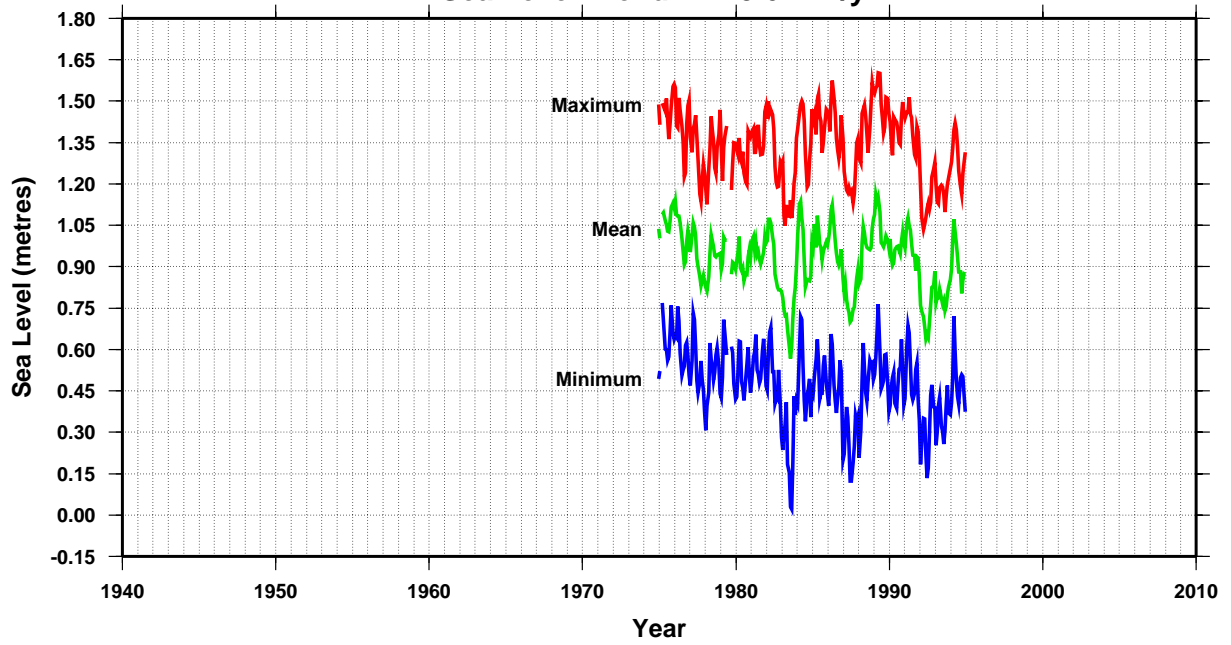

3.4. Predicted highest astronomical tide

The component of sea level that is predictable due to the influence of the Sun and the Moon and some seasonal effects allow us to calculate the highest predictable level each year. The highest astronomical tide is the highest sea level that can be predicted under any combination of astronomical conditions, including the proximity of the earth to the sun and the moon. Figure 14 shows that the highest predicted level (1.01 m) over the period 1990 to 2016 is at 04:59 Local Time on 21 April 2007.

Figure 14

Predicted highest tide each year for Honiara

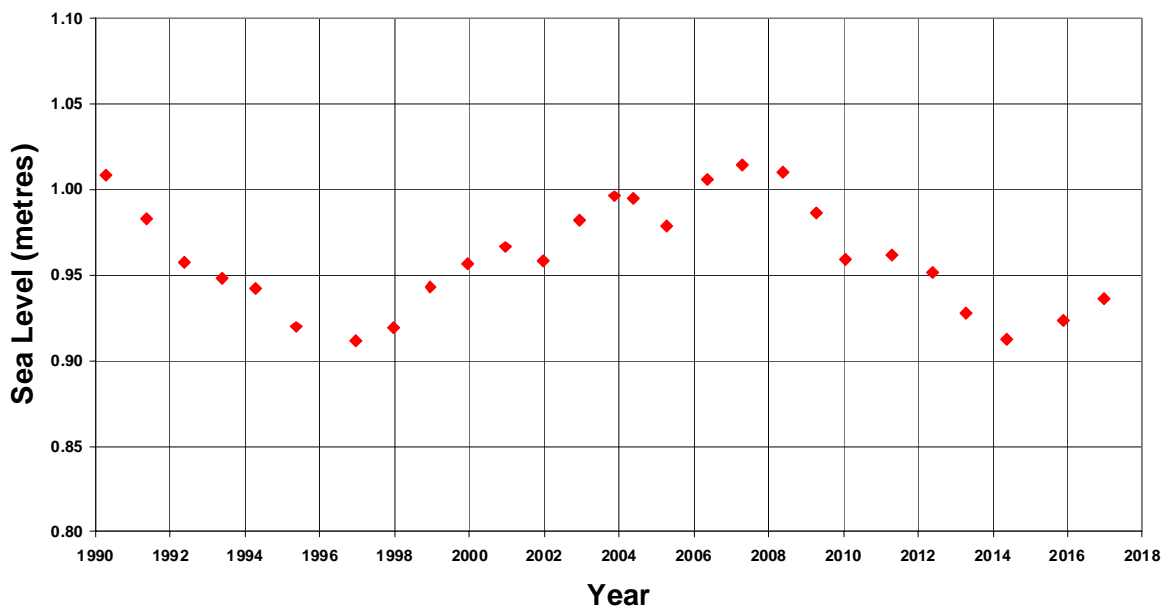

3.5. Monthly mean air temperature, water temperature, and atmospheric pressure

The data summarised in Figures 15-17 follows the same format as the monthly sea level plot: the middle curve (green) represents the monthly mean, and the upper and lower curves show the highest and lowest values recorded each month.

Compared to the sites further from the equator, the Solomon Islands undergo much less seasonal temperature variation. However, the summertime highs are normally recorded in December, January, or February. The mean air temperature over the duration of the record is 26.8°C. The minimum air temperature was 20.1°C in October 1995, and a maximum was 34.5°C in December 2001.

Figure 15

Monthly air temperature at Honiara
SEAFRAME gauge

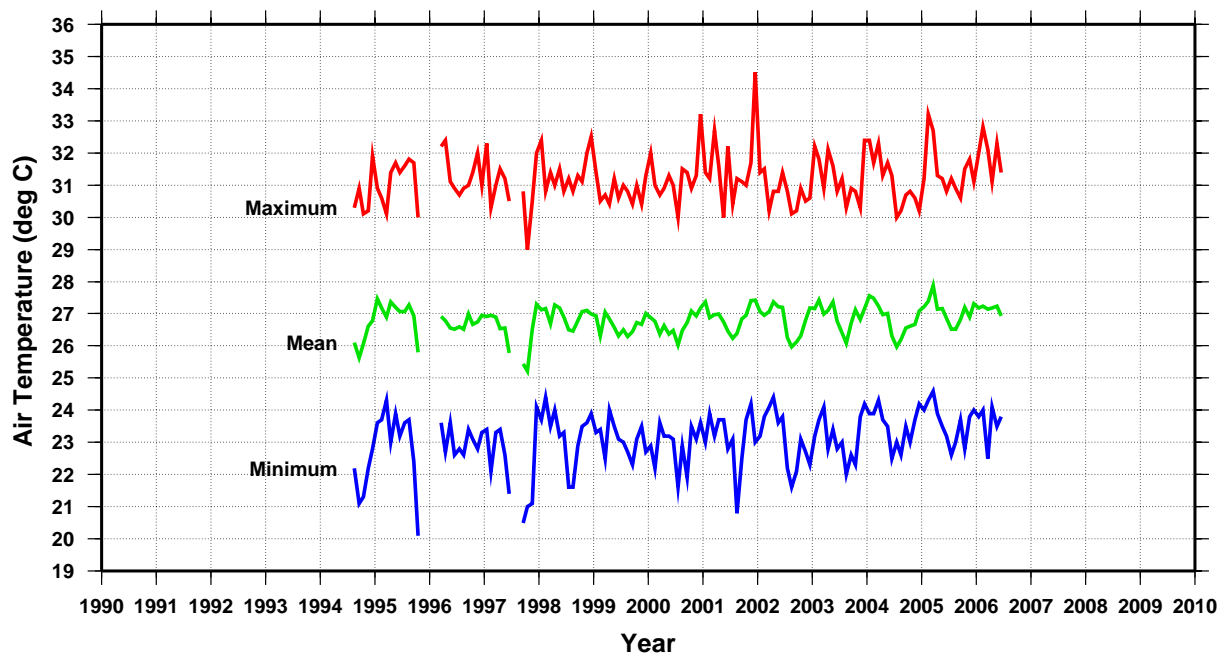

Water temperature also undergoes seasonal oscillations, which are more or less in phase with those of air temperature, but more pronounced. Also, the water temperature tends to have a much broader peak, reflecting the slower response time of the ocean compared to the atmosphere. The Solomon Islands experienced mean air and water temperatures of about 2° below normal during the 1997/1998 El Niño. The mean water temperature over the duration of the record is 29.3°C. The highest recorded water temperature was 31.9°C in March 2000, and the minimum was 26.5°C in October 1998.

Figure 16

**Monthly water temperature at Honiara
SEAFRAME gauge**

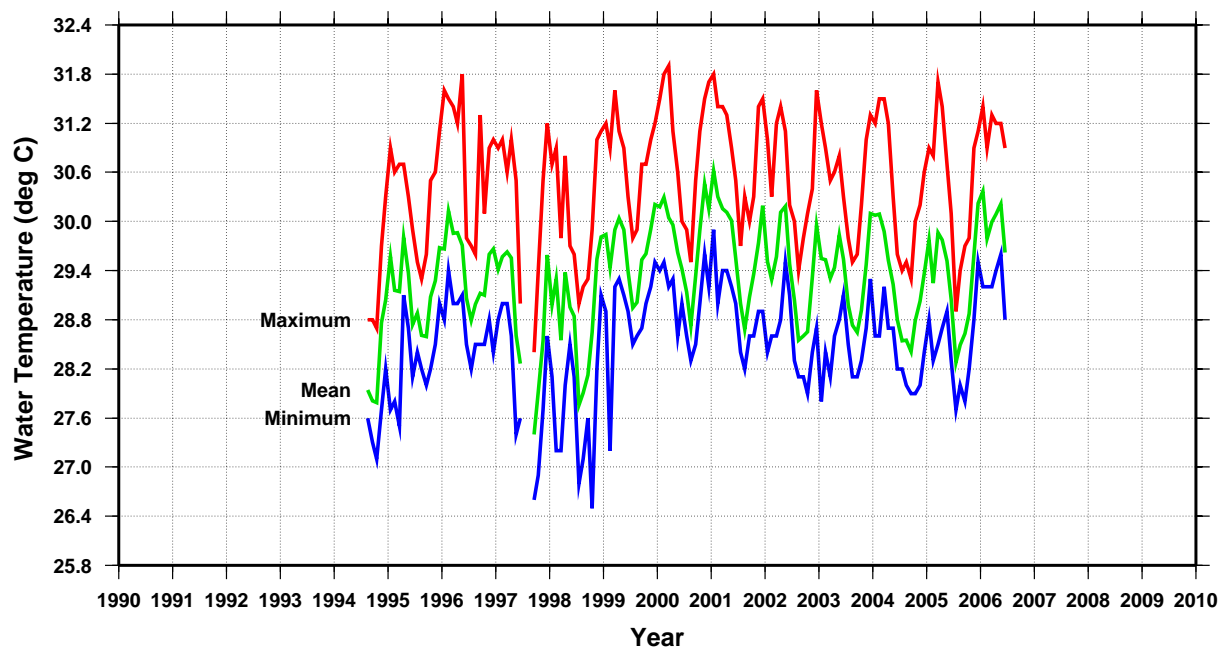

The sea level also responds to changes in barometric pressure. As a rule of thumb, a 1 hPa fall in the barometer, if sustained over a day or more, produces a 1 cm rise in the local sea level (within the area beneath the low pressure system). The seasonal (summertime) high sea levels at Honiara are correlated with low barometric pressure systems. The mean barometric pressure over the duration of the record is 1008.8 hPa. The highest pressure recorded was 1016.6 hPa in September 1997, while the lowest was 994.7 hPa in December 1996.

Figure 17

**Monthly atmospheric pressure at Honiara
SEAFRAME gauge**

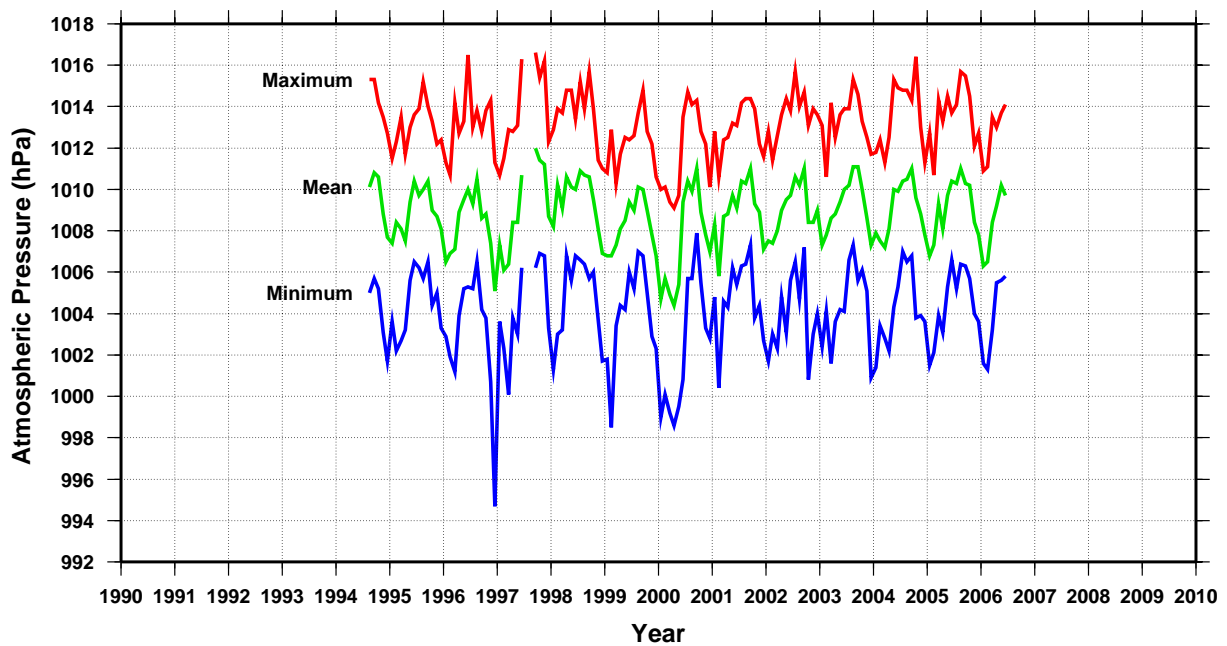

3.6. Precise Levelling Results for Solomon Islands

While the SEAFRAME gauge exhibits a high degree of datum stability, it is essential that the datum stability be checked periodically by precise levelling to an array of deep-seated benchmarks located close to the tide gauge. For example, a wharf normally supports the SEAFRAME, and wharf pilings are often subject to gradual vertical adjustment, which in turn can raise or lower the SEAFRAME.

Precise levelling is carried out on a regular 18-monthly cycle between the SEAFRAME Sensor Benchmark and an array of at least six deep benchmarks. The nearest stable benchmark is designated the “Tide Gauge Benchmark (TGBM)”, and the others are considered the “coastal array”.

Figure 18 summarises the most important survey information being the movement of the SEAFRAME Sensor benchmark relative to the TGBM. The graph does not include the results for the other benchmarks on the coastal array. In this graph, each survey is plotted relative to the first. Thus, the second survey at the Solomon Islands found that the SEAFRAME Sensor benchmark had *risen* relative to the TGBM by 0.5 mm, but overall it has sunk at an average rate of 0.4 mm/year.

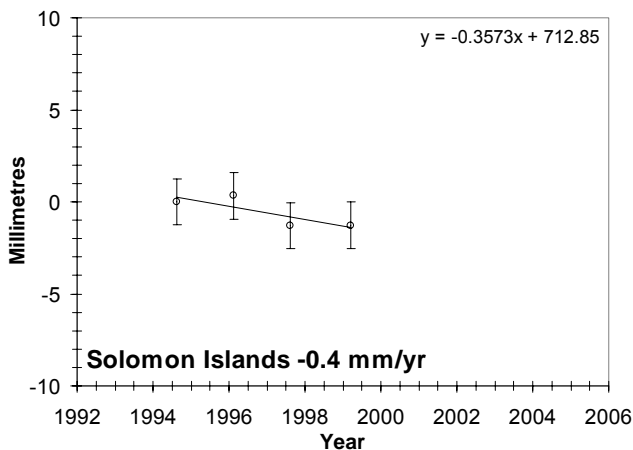

Figure 18. Movement of the SEAFRAME Sensor relative to the Tide Gauge Bench Mark.



Levelling of SEAFRAME Sensor benchmark. Photo credit: Steve Turner, NTC.

Appendix

A.1. Definition of Datum and other Geodetic Levels at Honiara, Solomon Islands

Newcomers to the study of sea level are confronted by bewildering references to “Chart Datum”, “Tide Staff Zero”, and other specialised terms. Frequent questions are, “how do NTC sea levels relate to the depths on the marine chart?” and “how do the UH sea levels relate to NTC’s?”.

Regular surveys to a set of coastal benchmarks are essential. If a SEAFRAME gauge or the wharf to which it is fixed were to be damaged and needed replacement, the survey history would enable the data record to be “spliced across” the gap, thereby preserving the entire invaluable record from start to finish.

Figure 19

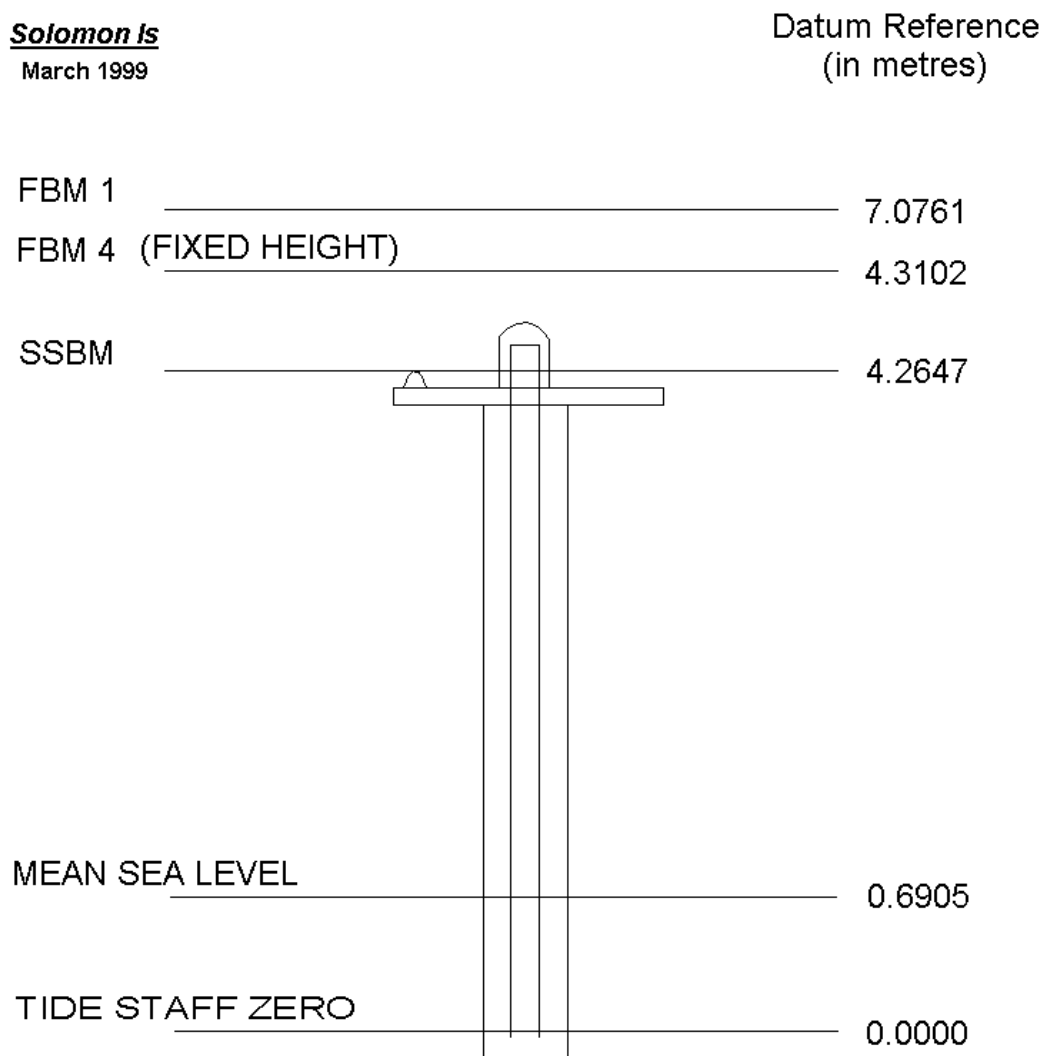

The word “datum” in relation to tide gauges and nautical charts means a reference level. Similarly, when you measure the height of a child, your datum is the floor on which the child stands.

“Sea levels” in the NTC data are normally reported relative to “Chart Datum” (CD), thus enabling users to relate the NTC data directly to depth soundings shown on marine charts – if the NTC sea level is +1.5 metres, an additional 1.5 metres of water may be added to the chart depths.

Mean Sea Level (MSL) in Figure 19 is the average recorded level over an extended period of time. MSL at Honiara is 0.6905 metres above the SEAFRAME datum.

