

# **Pacific Country Report**

## **Sea Level & Climate: *Their Present State***

*Tuvalu*

**June 2006**

### Disclaimer

The views expressed in this publication are those of the authors and not necessarily those of the Australian Agency for International Development (AusAID).

**PACIFIC COUNTRY REPORT  
ON  
SEA LEVEL & CLIMATE: THEIR PRESENT STATE**

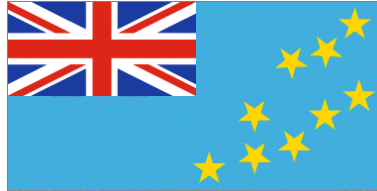

**TUVALU**

**June 2006**

**Executive Summary**

- A SEAFRAME gauge was installed in Funafuti, Tuvalu, in March 1993. It records sea level, air and water temperature, atmospheric pressure, wind speed and direction. It is one of an array designed to monitor changes in sea level and climate in the Pacific.
- This report summarises the findings to date, and places them in a regional and historical context.
- The sea level trend to date is +6.4 mm/year but the magnitude of the trend continues to vary widely from month to month as the data set grows. Accounting for the precise levelling results and inverted barometric pressure effect, the trend is +5.7 mm/year. A nearby gauge, with a longer record but less precision and datum control, shows a trend of +0.9 mm/year.
- Variations in monthly mean sea level, air and water temperatures are dominated by seasonal cycles and were affected by the 1997/1998 El Niño.
- The seasonal sea level cycle shows a peak early in the year, a time when Funafuti frequently experiences flooding.
- Since installation, at least two cyclones have passed through Tuvalu, but only one, Tropical Cyclone Gavin, was registered as extreme low pressure on the SEAFRAME at Funafuti.
- The SEAFRAME at Funafuti, Tuvalu recorded small tsunami signals of around 5cm following a magnitude Mw 7.3 earthquake near Vanuatu in November 1999 and a magnitude Mw8.4 earthquake near Peru in June 2001.

## Contents

	Page
Executive Summary	2
1. Introduction	4
2. Regional Overview	5
2.1. Regional Climate and Oceanography	5
2.2. Sea level datasets from SEAFRAME stations	8
2.2.1. Vertical datum control of SEAFRAME sensors	10
2.2.2. Inverted barometric pressure effect	12
2.2.3. Combined net rate of relative sea level trends	13
2.3. Sea level datasets from additional stations	14
2.4. Satellite altimetry	17
3. Project Findings to Date – Tuvalu	19
3.1. Extreme events	19
3.1.1. Tropical cyclones	19
3.1.2. Tsunamis	20
3.2. SEAFRAME sea level record and trend	22
3.3. Additional sea level records and trend	24
3.4. Predicted highest astronomical tide	26
3.5. Monthly mean air temperature, water temperature, and atmospheric pressure	27
3.6. Precise Levelling Results for Tuvalu	30
Appendix	
A.1. Definition of Datum and other Geodetic Levels at Funafuti	31

## **1. Introduction**

As part of the AusAID-sponsored South Pacific Sea Level and Climate Monitoring Project ("Pacific Project") for the FORUM region, in response to concerns raised by its member countries over the potential impacts of an enhanced Greenhouse Effect on climate and sea levels in the South Pacific region, a **SEAFRAME** (**Sea Level Fine Resolution Acoustic Measuring Equipment**) gauge was installed in Funafuti, Tuvalu, in March 1993. The gauge has been returning high resolution, good scientific quality data since installation.

SEAFRAME gauges not only measure sea level by two independent means, but also a number of "ancillary" variables - air and water temperatures, wind speed, wind direction and atmospheric pressure. There is an associated programme of levelling to "first order", to determine vertical movement of the sea level sensors due to local land movement. A Continuous Global Positioning System (CGPS) station was installed in Tuvalu in December 2001 to determine the vertical movement of the land with respect to the International Terrestrial Reference Frame.

When change in sea level is measured with a tide gauge over a number of years one cannot be sure whether the sea is rising or the land is sinking. Tide gauges measure relative sea level change, i.e., the change in sea level relative to the tide gauge, which is connected to the land. To local people, the relative sea level change is of paramount importance. Vertical movement of the land can have a number of causes, e.g. island uplift, compaction of sediment or withdrawal of ground water. From the standpoint of global change it is imperative to establish absolute sea level change, i.e. sea level referenced to the centre of the Earth, which is to say in the terrestrial reference frame. In order to accomplish this, the rate at which the land moves must be measured separately. This is the reason for the addition of CGPS near the tide gauges.

## **2. Regional Overview**

### **2.1. Regional Climate and Oceanography**

Variations in sea level and atmosphere are inextricably linked. For example, to understand why the sea level at Tuvalu undergoes a much larger annual fluctuation than at Samoa, we must study the seasonal shifts of the trade winds. On the other hand, the climate of the Pacific Island region is entirely ocean-dependent. When the warm waters of the western equatorial Pacific flow east during El Niño, the rainfall, in a sense, goes with them, leaving the islands in the west in drought.

Compared to higher latitudes, air temperatures in the tropics vary little throughout the year. Of the SEAFRAME sites, those furthest from the equator naturally experience the most extreme changes – the Cook Islands (at 21°S) recorded the lowest temperature, 13.1°C, in August 1998. The Cook Islands regularly fall to 16°C while Tonga (also at 21°S) regularly falls to 18°C in winter (July/August).

**Table 1. Range in air temperatures observed at SEAFRAME stations**

<b>SEAFRAME location</b>	<b>Minimum recorded air temperature (°C)</b>	<b>Maximum recorded air temperature (°C)</b>
Cook Islands	13.1	32.0
Tonga	16.0	31.4
Fiji (Lautoka)	16.6	33.4
Vanuatu	16.5	33.3
Samoa	18.7	32.3
Tuvalu	22.8	33.7
Kiribati	22.4	32.9
Nauru	22.4	33.0
Solomon Islands	20.1	34.5
Papua New Guinea	21.5	31.8
Marshall Islands	22.0	31.9
FSM	23.0	31.8

The most striking oceanic and climate fluctuations in the equatorial region are not the seasonal, but interannual changes associated with El Niño. These affect virtually every aspect of the system, including sea level, winds, precipitation, and air and water temperature. Referring to Figure 1, we see that at most SEAFRAME sites, the lowest recorded sea levels appear during the 1997/1998 El Niño. The most dramatic effects were observed at the Marshall Islands, PNG, Nauru, Tuvalu and Kiribati, and along a band extending southeastward from PNG to Samoa. The latter band corresponds to a zone meteorologists call the “South Pacific Convergence Zone” or SPCZ (sometimes called the “Sub-Tropical Convergence Zone”, or STCZ).

Figure 1. Sea level anomalies\* at SEAFRAME sites

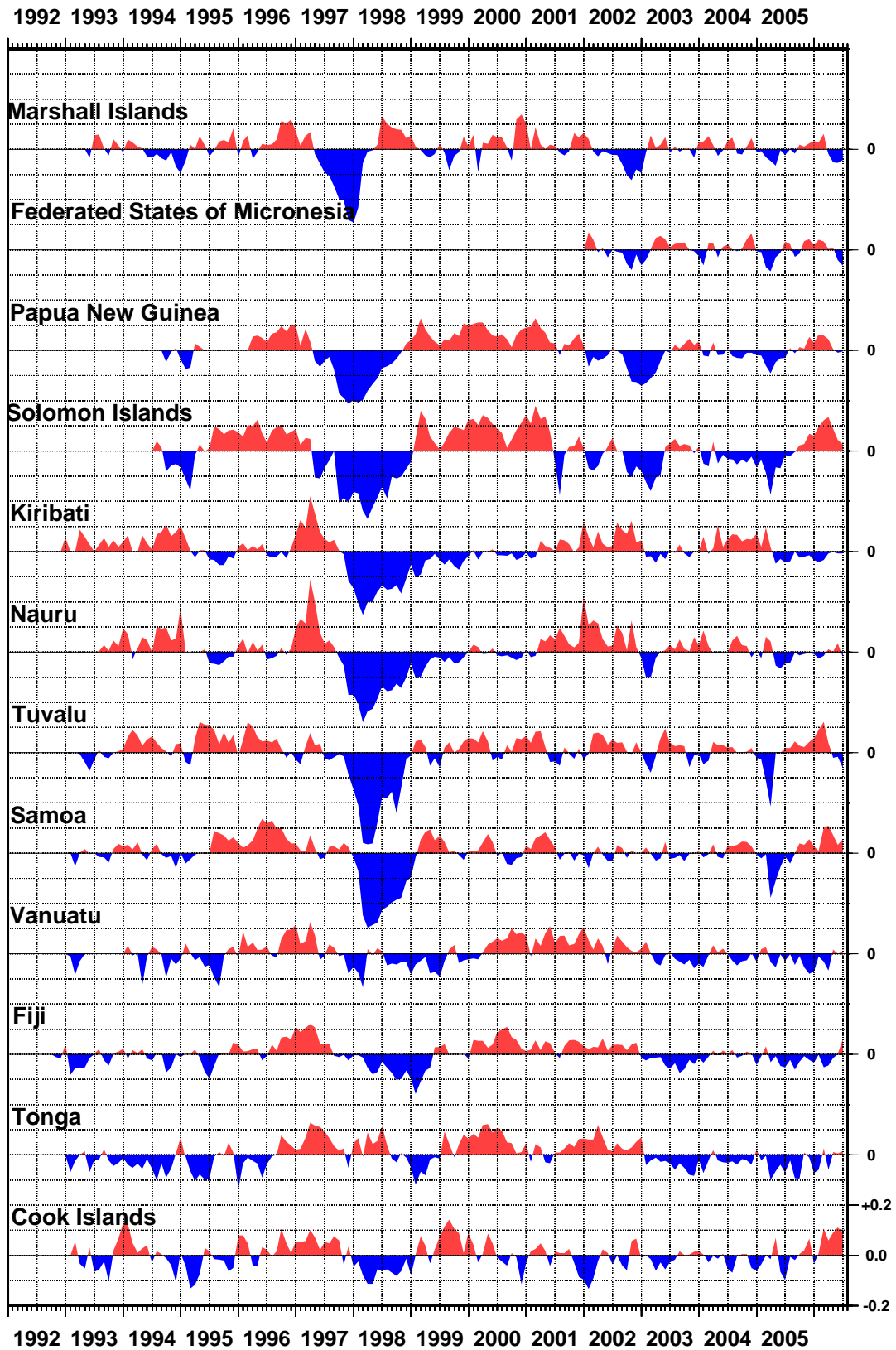

\* Sea level “anomalies” have had tides, seasonal cycles and trend removed from the sea level observations.

Most Pacific Islanders are very aware that the sea level is controlled by many factors, some periodic (like the tides), some brief but violent (like cyclones), and some prolonged (like El Niño), because of the direct effect the changes have upon their lives. The effects vary widely across the region. Along the Melanesian archipelago, from Manus Island to Vanuatu, tides are predominantly diurnal, or once daily, while elsewhere the tide tends to have two highs and two lows each day. Cyclones, which are fueled by heat stored in the upper ocean, tend to occur in the hottest month. They do not occur within 5° of the equator due to the weakness of the “Coriolis Force”, a rather subtle effect of the earth’s rotation. El Niño’s impact on sea level is mostly felt along the SPCZ, because of changes in the strength and position of the Trade Winds, which have a direct bearing on sea level, and along the equator, due to related changes in ocean currents. Outside these regions, sea levels are influenced by El Niño, but to a far lesser degree.

**Figure 2. Mean surface water temperature**

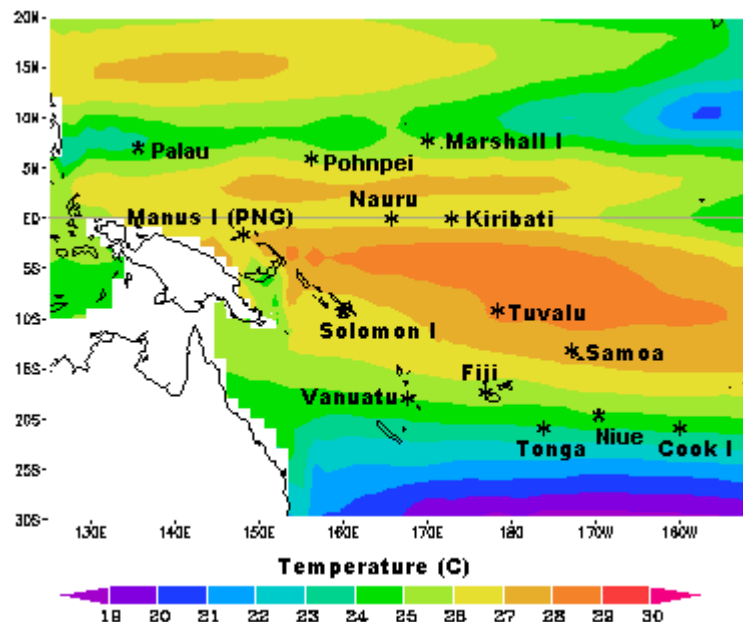

Note the warm temperatures in the SPCZ and just north of the equator.

The convergence of the Trade Winds along the SPCZ has the effect of deepening the warm upper layer of the ocean, which affects the seasonal sea level. Tuvalu, which is in the heart of the SPCZ, normally experiences higher-than-average sea levels early each year when this effect is at its peak. At Samoa, the convergence is weaker, and the seasonal variation of sea level is far less, despite the fact that the water temperature recorded by the gauge varies in a similar fashion. The interaction of wind, solar heating of the oceanic upper layer, and sea level, is quite complex and frequently leads to unexpected consequences.

The Streamlines of Mean Surface Wind (Figure 3) shows how the region is dominated by easterly trade winds. In the Southern Hemisphere the Trades blow to the northwest and in the Northern Hemisphere they blow to the southwest. The streamlines converge, or crowd together, along the SPCZ.

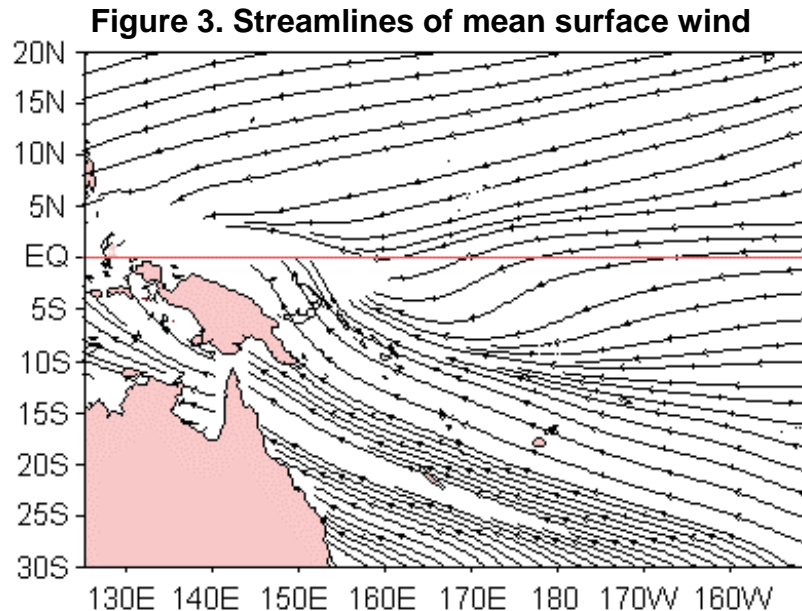

Much of the Melanesian subregion is also influenced by the Southeast Asian Monsoon. The strength and timing varies considerably, but at Manus Island (PNG), for example, the NW monsoon season (winds from the northwest) runs from November to March, while the SE monsoon brings wind (also known as the Southeast Trade Winds) from May to October. Unlike many monsoon-dominated areas, the rainfall at Manus Island is distributed evenly throughout the year (in normal years).

## **2.2. Sea Level Datasets from SEAFRAME stations**

A key objective of the South Pacific Sea Level and Climate Monitoring Project (SPSLCMP) is to provide an accurate long-term sea level record. SEAFRAME stations were installed from 1992 onwards to provide precise relative sea level measurements. The SEAFRAMES undergo regular calibration and maintenance and are levelled against a network of land-based benchmarks to maintain vertical datum control. The SEAFRAME observations are transmitted hourly via satellite and are processed using specific quality control procedures.

The project's data collection program has been operating for a relatively short term and so the sea level trends are still prone to the effects of shorter-term ocean variability (such as El Niño and decadal oscillations). As the data sets increase in length, the trend estimates will begin to reflect longer-term change rather than short-term fluctuations. Figure 4 shows how the sea level trends from SEAFRAME stations have evolved from one year after installation to the present. These trends will continue to stabilise for many more years, as is demonstrated by Figure 5.



**Figure 4. Evolution of relative sea level trends (mm/year) at SEAFRAME stations. The trends continue to stabilise as the lengths of records increase.**

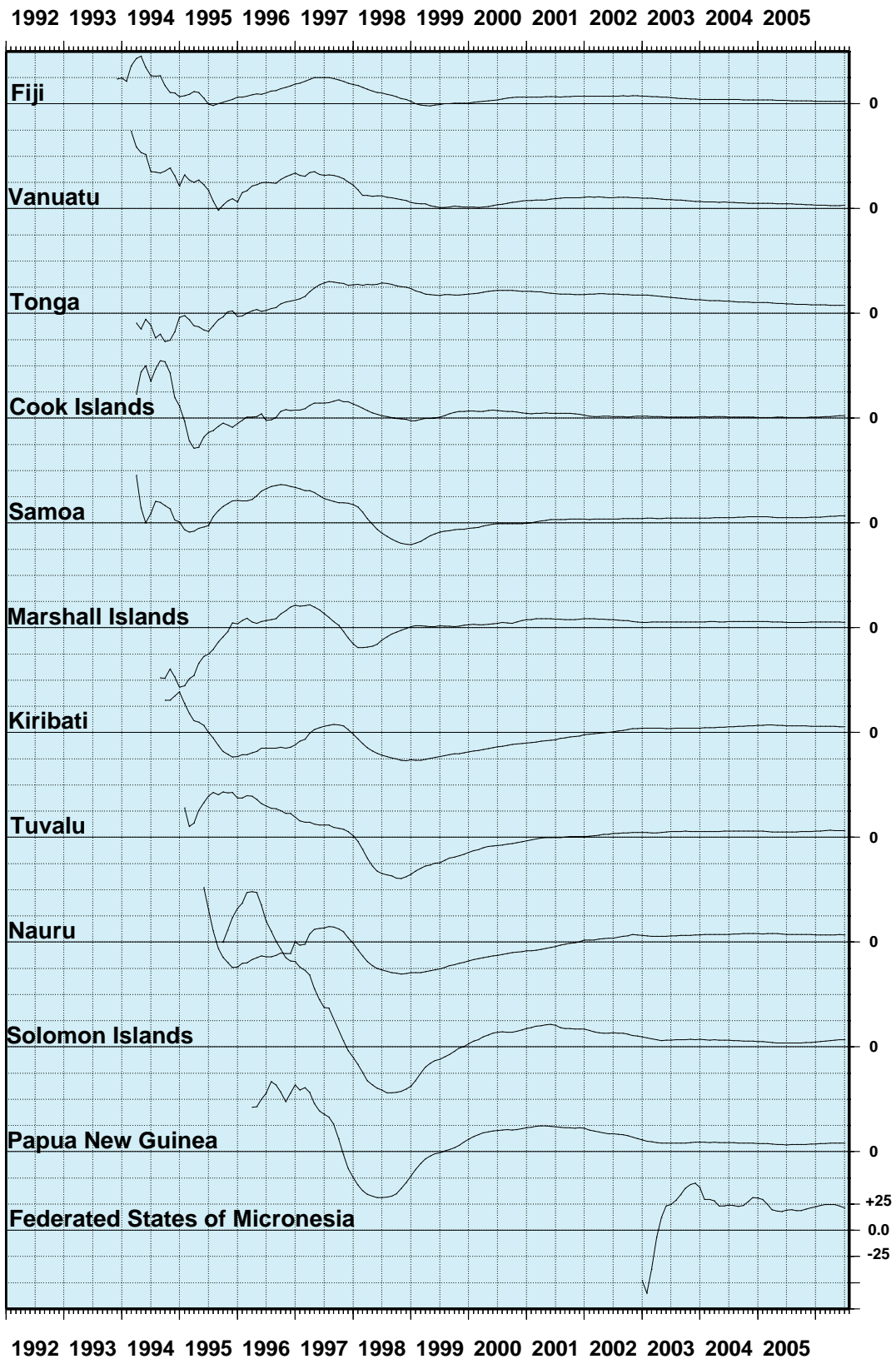

### 2.2.1 Vertical datum control of SEAFRAME sensors

Precise levelling of the height of the SEAFRAME sea level sensor relative to an array of land-based benchmarks is undertaken periodically, preferably every eighteen months. The precision to which the survey must be performed is dependent on the distance  $K_m$  (km) between the SEAFRAME sensor benchmark and the primary tide gauge benchmark (TGBM) and forms part of the project's design specifications.

The precise levelling program enables the vertical stability of the SEAFRAMES to be monitored. Registering the sea levels to land is especially important if the SEAFRAME needs to be replaced or relocated or is displaced by a boat or a storm. The rates of vertical movement of the gauges relative to the TGBM (determined by fitting a straight line to the survey results) that are contributing to observed sea level trends are listed in Table 2. Substantial subsidence of the tide gauge at Samoa is occurring at a rate of -1.1 mm/year. Subsidence is also occurring at Marshall Islands and Solomon Islands. The tide gauges at Cook Islands, Fiji, and Vanuatu are rising at 0.3 mm/year with respect to the tide gauge benchmark. The rates of vertical tide gauge movement are used to correct observed rates of relative sea level change.

**Table 2. Distance (km), required survey precision (mm), number of surveys and the rate of vertical movement of the SEAFRAME relative to the TGBM.**

Location	$K_m$ (km)	$\pm 2 \sqrt{K_m}$ (mm)	Number of Surveys	Vertical movement (mm/year)
Cook Is	0.491	1.4	8	+0.3
FSM	0.115	0.7	2	N/A
Fiji	0.522	1.4	8	+0.3
Kiribati	0.835	1.8	9	+0.1
Marshall Is	0.327	1.1	8	-0.5
Nauru	0.120	0.7	9	+0.0
PNG	0.474	1.4	7	-0.2
Samoa	0.519	1.4	8	-1.1
Solomon Is	0.394	1.3	4	-0.4
Tonga	0.456	1.4	8	-0.1
Tuvalu	0.592	1.5	8	-0.1
Vanuatu	1.557	2.5	7	+0.3

Continuous Geographical Positioning Systems (CGPS) stations have also been installed on most of the islands where SEAFRAME gauges are located (Table 3). The purpose of the CGPS program is to close the final link in establishing vertical datum control – that is, to determine whether the island or coastal region as a whole is moving vertically with respect to the International Terrestrial Reference Frame. Early estimates of the rates of vertical movement are supplied in Table 3 but continued monitoring is necessary before meaningful results emerge from the CGPS time series data. The latest CGPS information for the project is available from Geosciences Australia at <http://www.ga.gov.au/geodesy/slm/spslcmp/>

**Table 3. Status of CGPS installations and results to June 30, 2005\***

Location	Date of Installation	Trend in Height Component* (mm/year)	Uncertainty (mm/year)
Cook Is	10 September 2001	-2.1	0.6
FSM	1 May 2003	6.0	2.1
Fiji	25 November 2001	2.9	0.7
Kiribati	4 August 2002	0.0	1.1
Marshall Is	Not yet installed		
Nauru	30 June 2003	7.8	2.3
PNG	1 May 2002	5.3	0.9
Samoa	1 July 2001	-0.3	0.5
Solomon Is	Not yet installed		
Tonga	18 February 2002	1.8	0.8
Tuvalu	2 December 2001	-0.2	0.7
Vanuatu	11 September 2002	1.7	0.9
Palau	Not yet installed		
Niue	Not yet installed		

**\*Note of Caution:**

'It is important to note that the length of the time series is too short for reliable vertical station velocity estimation. As the data collection and the height time series becomes longer, and the strategy of simultaneous estimation of velocities and periodical or seasonal signals is used, the estimates of the vertical crustal motion will become more accurate and reliable.'

*South Pacific Sea Level and Climate Monitoring GPS Coordinate Time Series.*

*Geosciences Australia Online Report*

[http://www.ga.gov.au/image\\_cache/GA6732.pdf](http://www.ga.gov.au/image_cache/GA6732.pdf)

### **2.2.2. Inverted barometric pressure effect**

Another parameter that influences the estimates of relative sea level rise is atmospheric pressure. Known as the inverted barometer effect, if a 1 hPa fall in barometric pressure is sustained over a day or more, a 1 cm rise is produced in the local sea level (within the area beneath the low pressure system). Therefore, if there are trends in the barometric pressure recorded at the tide gauge sites, there will be a contribution to the observed relative sea level trends. The contribution will be a 10 mm/year increase (decrease) in relative sea levels for a 1 hPa/year decrease (increase) in barometric pressure.

Estimates of the contribution to relative sea level trends by the inverted barometric pressure effect at all SEAFRAME sites over the period of the project are listed in Table 4. The estimates are mostly positive, which means relative sea level trends are overestimated without taking the barometric pressure effect into consideration. An inverse barometer correction can be applied to observed rates of relative sea level change.

**Table 4. Recent short-term barometric pressure trends expressed as equivalent sea level rise in mm/year based upon SEAFRAME data to June 2006.**

<b>Location</b>	<b>Installed</b>	<b>Barometric Pressure Contribution to Sea Level Trend (mm/yr)</b>
Cook Is	19/02/1993	0.3
FSM	17/12/2001	-0.5
Fiji	23/10/1992	1.1
Kiribati	02/12/1992	0.5
Marshall Is	07/05/1993	0.3
Nauru	07/07/1993	0.6
PNG	28/09/1994	1.7
Samoa	26/02/1993	0.4
Solomon Is	28/07/1994	-0.3
Tonga	21/01/1993	0.9
Tuvalu	02/03/1993	0.6
Vanuatu	15/01/1993	1.2

\*The trend at FSM is from a comparatively short series and therefore varies considerably.

### 2.2.3. Combined net rate of relative sea level trends

The effects of the vertical movement of the tide gauge platform and the inverse barometer effect are removed from the observed rates of relative sea level change and presented in Table 5. These net rates are spatially coherent (with the exception of FSM and Tonga) and consistent with regional sea level trends observed from satellite altimeters over a similar timeframe. The net sea level trend at FSM is comparatively large because it is derived from a comparatively short record. The net sea level trend at Tonga is large in comparison to its neighbouring sites (Cook Islands and Fiji), which could possibly be due to vertical motion of the whole island, but the CGPS record there is still too short (since February 2002) for this motion to be reliably quantified.

**Table 5. The net relative sea level trend estimates as at June 2006 after the inverted barometric pressure effect and vertical movements in the observing platform are taken into account.**

Location	Installed	Sea Level Trend (mm/yr)	Barometric Pressure Contribution (mm/yr)	Vertical Tide Gauge Movement Contribution* (mm/yr)	Net Sea Level Trend (mm/yr)
Cook Is	19/02/1993	2.5	0.3	-0.3	2.5
FSM**	17/12/2001	21.4	-0.5	N/A	20.9
Fiji	23/10/1992	2.5	1.1	-0.3	1.7
Kiribati	02/12/1992	5.7	0.5	-0.1	5.3
Marshall Is	07/05/1993	5.2	0.3	+0.5	4.4
Nauru	07/07/1993	7.1	0.6	-0.0	6.5
PNG	28/09/1994	8.1	1.7	+0.2	6.2
Samoa	26/02/1993	6.9	0.4	+1.1	5.4
Solomon Is	28/07/1994	6.8	-0.3	+0.4	6.7
Tonga	21/01/1993	8.0	0.9	+0.1	7.0
Tuvalu	02/03/1993	6.4	0.6	+0.1	5.7
Vanuatu	15/01/1993	3.1	1.2	-0.3	2.2

\*The contribution is the inverse rate of vertical tide gauge movement

\*\* The sea level trend at FSM is derived from a comparatively short data record.

### 2.3. Sea Level Datasets from Additional Stations

Additional sea level data sets for the Pacific Forum Region are available from the Joint Archive for Sea Level (JASL). This archive was established in 1987 to supplement the University of Hawaii Sea Level Centre data holdings with contributions from other agencies. The research quality datasets available from the JASL may be accessed online at <http://uhslc.soest.hawaii.edu/uhslc/jasl.html>

Sea level in the Pacific Forum region undergoes large inter-annual and decadal variations due to dynamic oceanographic and climatic effects such as El Niño. Such variability or 'noise' affects estimates of the underlying long-term trend. In general, more precise sea level trend estimates are obtained from longer sea level records as is shown in Figure 5. Sea level records of less than 25 years are thought to be too short for obtaining reliable sea level trend estimates. A confidence interval or precision of 1 mm/year should be obtainable at most stations with 50-60 years of data on average, providing there is no acceleration in sea level change, vertical motion of the tide gauge, or abrupt shifts in trend due to tectonic events.

**Figure 5. 95% Confidence Intervals for linear mean sea level trends (mm/year) plotted as a function of the year range of data. Based on NOAA tide gauges with at least 25 years of record<sup>1</sup>.**

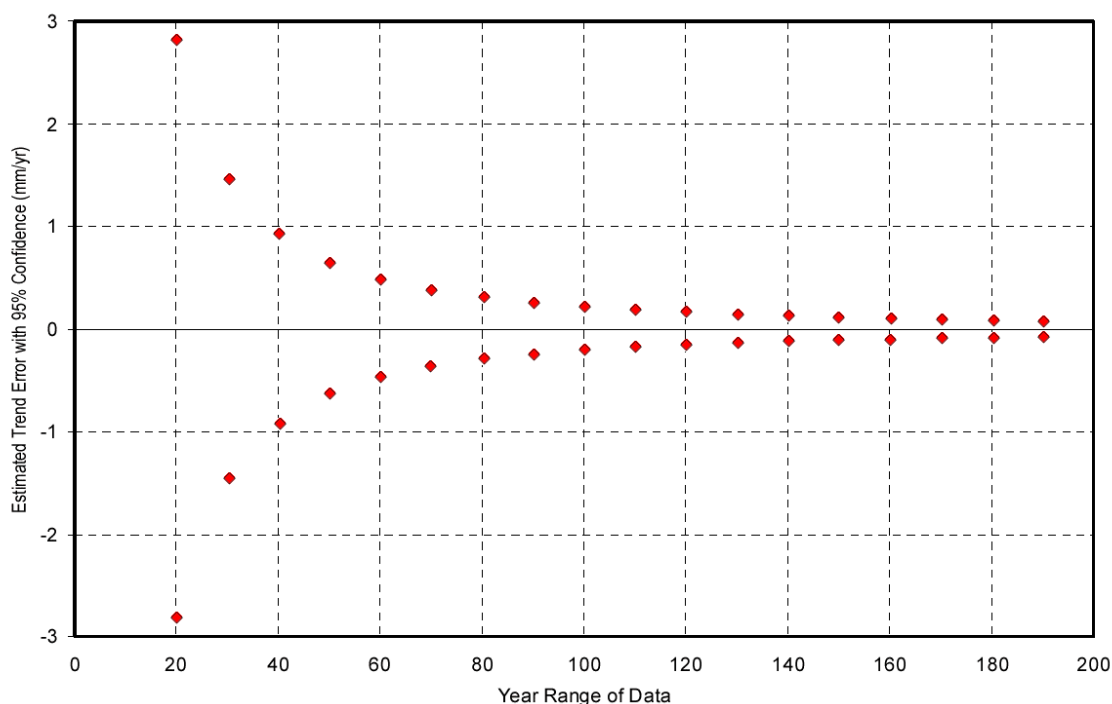

The annual mean sea levels and relative sea level trends for additional JASL sea level data sets are shown in Figure 6. The datasets are of different lengths covering different periods of time and climatic and sea level change. Many of the datasets are too short to provide reliable trend estimates. At some stations there are multiple sea level records, but joining them together can be problematic. They are archived separately on the Joint Archive for Sea Level because they either originate from different tide gauge

1. Zervas, C. (2001) Sea Level Variations of the United States 1854-1999. NOAA, USA.

locations or they have unrelated tide gauge datum.

Diverse climatic and oceanographic environments are found within the Pacific Islands region. Different rates of vertical land movement are likely at different stations. Many of the historical tide gauges were designed to monitor tides and sea level variability caused by El Niño and shorter-term oceanic fluctuations rather than long-term sea level change and lack the required level of instrumental precision and vertical datum control. All of these factors potentially affect the rates of relative sea level change that are listed in Table 6. The overall mean trend from stations with more than 25 years of data is 1.14 mm/year.

**Table 6. Sea level trends for Pacific Forum Stations on the Joint Archive for Sea Level Data Holdings as at March 2006.**

JASL	STATION	COUNTRY	START DATE	END DATE	SPAN (years)	TREND (mm/yr)
001a	Pohnpei-A	Fd St Micronesia	1-Jan-1969	31-Dec-1971	3	116.3
<b>001b</b>	<b>Pohnpei-B</b>	<b>Fd St Micronesia</b>	<b>1-Jan-1974</b>	<b>31-Dec-2004</b>	<b>31</b>	<b>1.78</b>
002a	Tarawa-A, Betio	Rep. of Kiribati	1-Jan-1974	31-Dec-1983	10	-5.26
002b	Tarawa-B, Bairiki	Rep. of Kiribati	1-Jan-1983	31-Dec-1988	6	29.76
002c	Tarawa-C, Betio	Rep. of Kiribati	1-Jan-1988	31-Dec-1997	10	3.27
004a	Nauru-A	Rep. of Nauru	1-Jan-1974	31-Dec-1995	22	-0.42
<b>005a</b>	<b>Majuro-A</b>	<b>Rep. Marshall I.</b>	<b>1-Jan-1968</b>	<b>31-Dec-1999</b>	<b>32</b>	<b>2.31</b>
006a	Enewetok-A	Rep. Marshall I.	1-Jan-1951	31-Dec-1971	21	1.29
006b	Enewetok-B	Rep. Marshall I.	1-Jan-1974	31-Dec-1979	6	-10.03
007a	Malakal-A	Rep. of Belau	1-Jan-1926	31-Dec-1939	14	-6.27
<b>007b</b>	<b>Malakal-B</b>	<b>Rep. of Belau</b>	<b>1-Jan-1969</b>	<b>31-Dec-2003</b>	<b>35</b>	<b>0.84</b>
008a	Yap-A	Fd St Micronesia	1-Jan-1951	31-Dec-1952	2	37.26
<b>008b</b>	<b>Yap-B</b>	<b>Fd St Micronesia</b>	<b>1-Jan-1969</b>	<b>31-Dec-2004</b>	<b>36</b>	<b>-0.42</b>
009a	Honiara-A	Solomon Islands	1-Jan-1974	31-Dec-1995	22	-5.65
<b>010a</b>	<b>Rabaul</b>	<b>Papua New Guinea</b>	<b>1-Jan-1966</b>	<b>31-Dec-1997</b>	<b>32</b>	<b>-2.21</b>
011a	Christmas-A	Rep. of Kiribati	1-Jan-1955	31-Dec-1972	18	-3.78
<b>011b</b>	<b>Christmas-B</b>	<b>Rep. of Kiribati</b>	<b>1-Jan-1974</b>	<b>31-Dec-2003</b>	<b>30</b>	<b>0.8</b>
012a	Fanning-A	Rep. of Kiribati	1-Jan-1957	31-Dec-1958	2	-21.67
012b	Fanning-B	Rep. of Kiribati	1-Jan-1972	31-Dec-1987	16	1.84
012c	Fanning-C	Rep. of Kiribati	1-Jan-1988	31-Dec-1990	3	118.86
013a	Kanton-A	Rep. of Kiribati	1-Jan-1949	31-Dec-1967	19	3.15
<b>013b</b>	<b>Kanton-B</b>	<b>Rep. of Kiribati</b>	<b>1-Jan-1972</b>	<b>31-Dec-2001</b>	<b>30</b>	<b>-0.43</b>
<b>018a</b>	<b>Suva-A</b>	<b>Fiji</b>	<b>1-Jan-1972</b>	<b>31-Dec-1997</b>	<b>26</b>	<b>4.67</b>
023a	Rarotonga-A	Cook Islands	1-Jan-1977	31-Dec-1997	21	4.34
<b>024a</b>	<b>Penrhyn</b>	<b>Cook Islands</b>	<b>1-Jan-1977</b>	<b>31-Dec-2003</b>	<b>27</b>	<b>1.69</b>
025a	Funafuti-A	Tuvalu	1-Jan-1977	31-Dec-1999	23	0.92
<b>029a</b>	<b>Kapingamarangi</b>	<b>Fd St Micronesia</b>	<b>1-Jan-1978</b>	<b>31-Dec-2003</b>	<b>26</b>	<b>1.46</b>
046a	Port Vila-A	Vanuatu	1-Jan-1977	31-Dec-1982	6	13.55
<b>053a</b>	<b>Guam</b>	<b>USA Trust</b>	<b>1-Jan-1948</b>	<b>31-Dec-2004</b>	<b>57</b>	<b>0.61</b>
<b>054a</b>	<b>Truk</b>	<b>Fd St Micronesia</b>	<b>1-Jan-1963</b>	<b>31-Dec-1991</b>	<b>29</b>	<b>1.79</b>
<b>055a</b>	<b>Kwajalein</b>	<b>Rep. Marshall I.</b>	<b>1-Jan-1946</b>	<b>31-Dec-2004</b>	<b>59</b>	<b>1.2</b>
<b>056a</b>	<b>Pago Pago</b>	<b>USA Trust</b>	<b>1-Jan-1948</b>	<b>31-Dec-2004</b>	<b>57</b>	<b>1.85</b>

The mean trend for datasets that span more than 25 years (bold font) is 1.14 mm/yr. Data from JASL as at March 2006

**Figure 6. Annual mean sea levels and linear sea level trends (mm/year) for additional stations on the Joint Archive for Sea Level.**

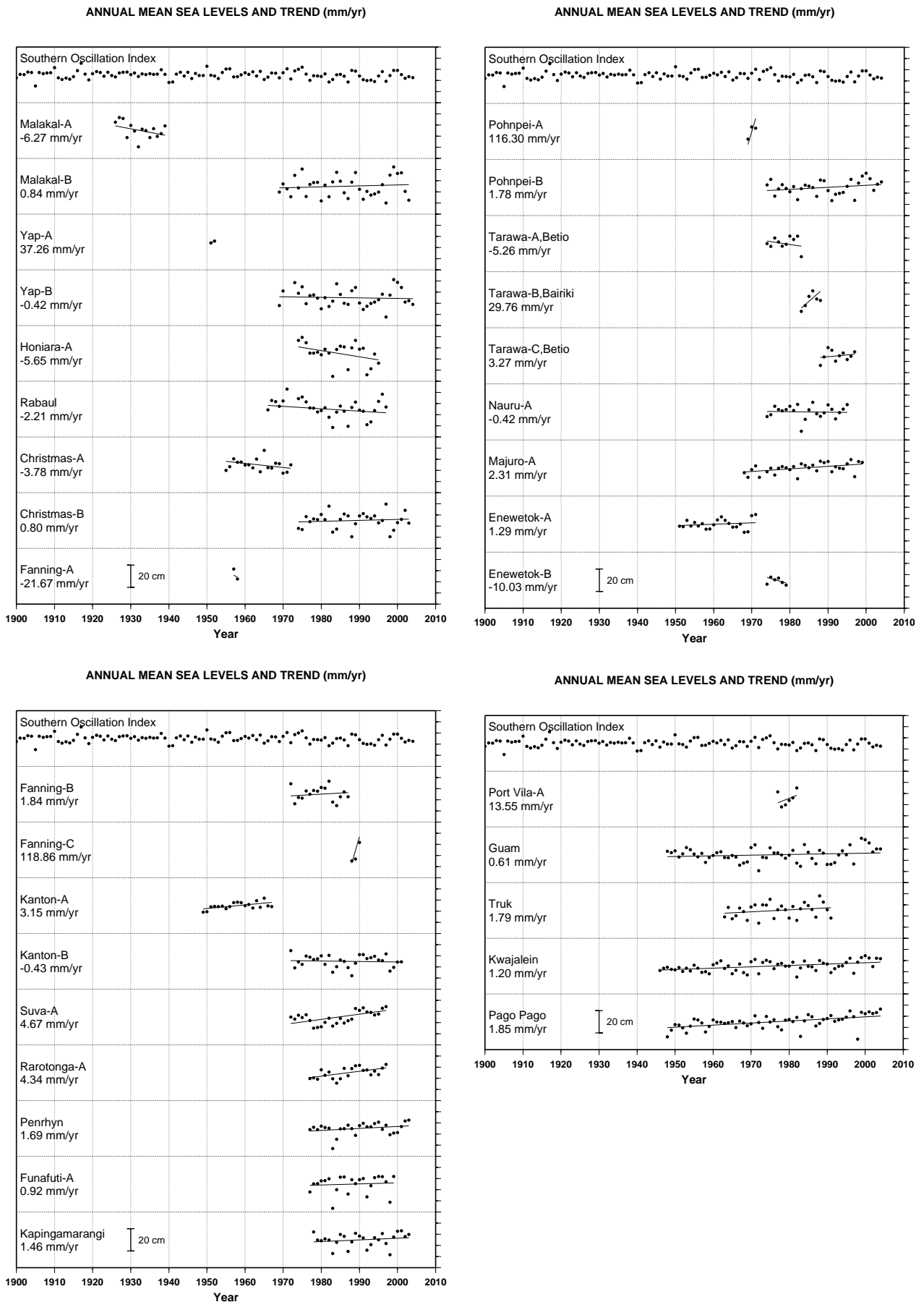



## 2.4. Satellite Altimetry

Satellite altimetry is technology that allows the height of the sea surface to be measured from satellites orbiting the earth. Satellites altimeters such as Topex/Poseidon and the follow-up mission Jason1 have provided a global record of sea level beginning in late 1992. Although the time interval between successive sea level measurements of the same position on earth is 10 days, the spatial coverage is particularly useful for mapping sea surface anomalies and monitoring development of basin scale events such as El Niño.

Satellite altimeters have an accuracy of several centimetres in the deep ocean, but are known to be inaccurate in shallow coastal regions. As such they cannot replace in-situ tide gauges. Tide gauges are needed to calibrate the satellite altimeters and provide accurate and more frequent sea level measurements in specific locations where reliable tide predictions and real time monitoring of extreme sea levels is of prime importance.

Information about global sea level change derived from satellite altimeters is available from the University of Colorado at <http://sealevel.colorado.edu/>.

Sea level data collected by Topex/Poseidon and Jason show that global mean sea level has risen at a rate of  $2.9 \pm 0.4$  mm/yr since late 1992 (Figure 7).

**Figure 7. Global Mean Sea Level Change Measured By Satellite Altimeters between Dec 1993 and Aug 2005. (Figure Courtesy Of University Of Colorado)**

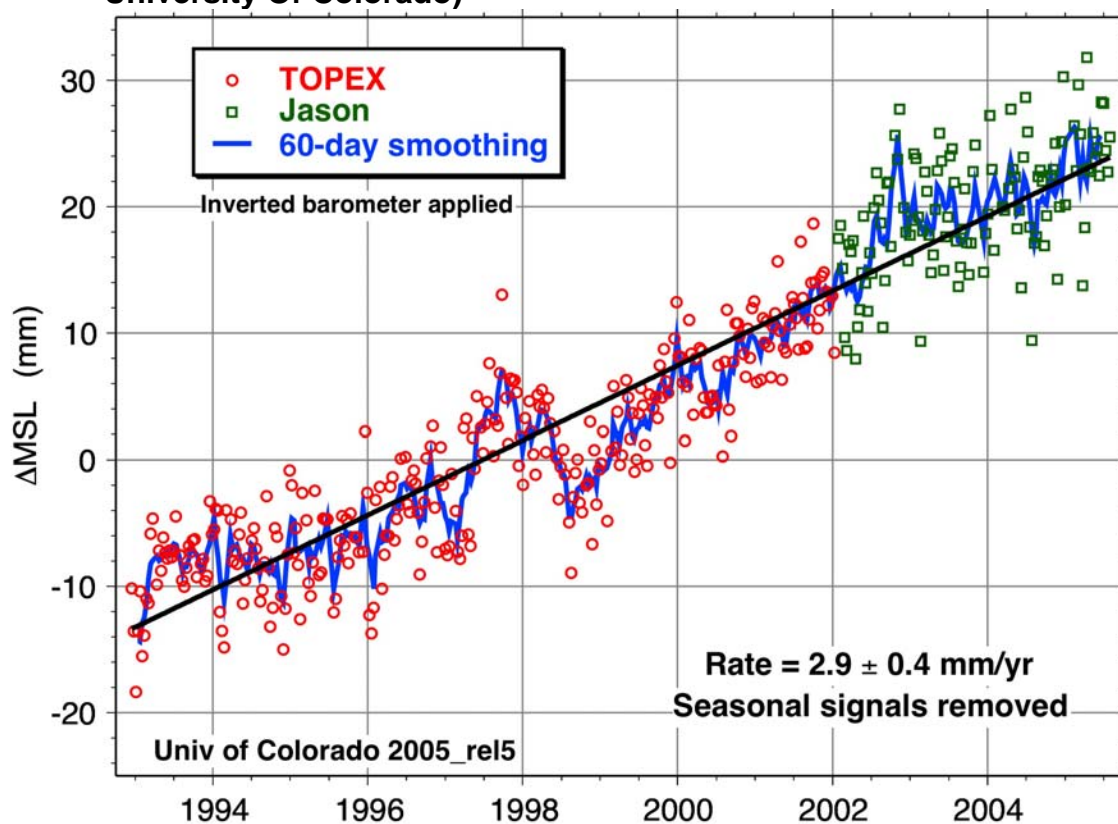

However global mean sea level change during this time has not been geographically uniform and continued monitoring is necessary (Figure 8). For example, sea level has risen at higher rates in the southwest Pacific region and has fallen in the northwest Pacific due to a basin-wide decadal 'slosh' in the Pacific Ocean. The satellite altimetry data has a similar length of record to the South Pacific Sea Level Monitoring Project SEAFRAME stations. The sea level trends from SEAFRAME stations (Table 5) are mostly higher than the global average rate shown in Figure 7, but this is consistent with the map of regional sea level trends shown in Figure 8.

**Figure 8. Regional Rates of Sea Level Change from December 1992 to Aug 2005 as measured by satellite altimeters. (Figure courtesy of University of Colorado)**

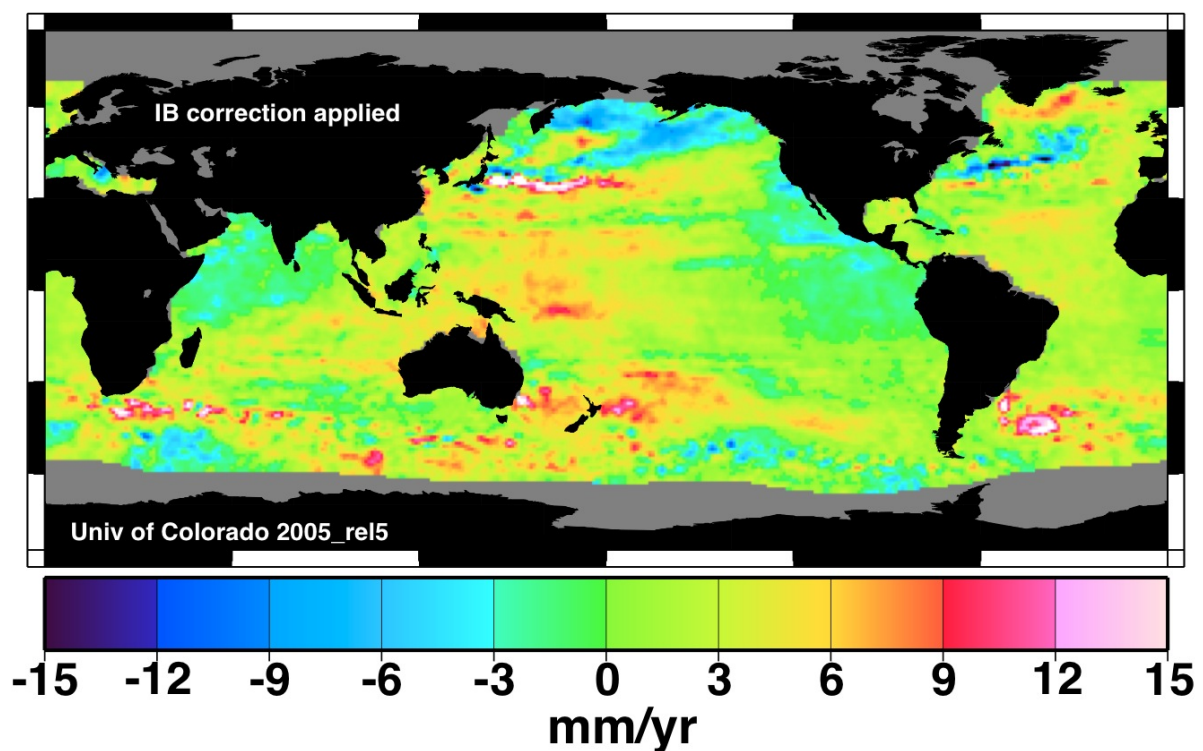

This section has provided an overview of aspects of the climate and sea level of the South Pacific Sea Level and Climate Monitoring Project region as a whole. The following section provides further details of project findings to date that are relevant to Tuvalu.

### **3. Project findings to date – Tuvalu**

#### **3.1. Extreme Events**

##### **3.1.1. Tropical Cyclones**

Tropical Cyclone Gavin originated close to the Southwest of Funafuti on the 3<sup>rd</sup> March 1997 (see Figure 9). The storm surge (the non-tidal part of the recorded sea level) generated by Gavin reached a peak of 0.3 metres on the 5<sup>th</sup> of March but since this was at a time of Neap tides, did not cause as much damage as it might have at Spring tides. However, Gavin did cause considerable erosion through wave action reaching into the lagoon.

**Figure 9. Track of Tropical Cyclone Gavin**

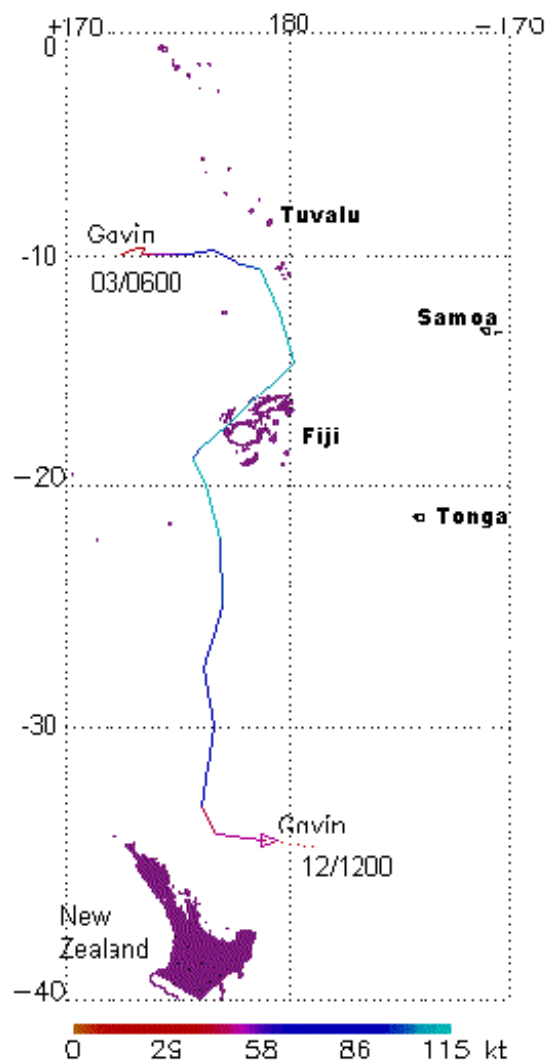

### 3.1.2. Tsunamis

A tsunami is a series of waves generated by an impulsive disturbance such as an undersea earthquake, coastal or submarine landslide, volcanic eruption, or asteroid impact. Tsunamis are most commonly generated along tectonic plate margins where earthquakes and volcanoes are found. Due to their association with seismic events tsunamis are also referred to as *seismic sea waves*. The term *tidal wave* is incorrect, as tsunamis have nothing to do with tide generating forces. Tsunami waves may be barely discernible in the open ocean but as they propagate into shallow coastal waters their size may increase significantly.

Figure 10 shows the sources of historical tsunami events listed in the *Integrated Tsunami Database for the Pacific and the Eastern Indian Ocean*<sup>1</sup>. A number of tsunamis have been generated in the South Pacific Sea Level and Climate Monitoring Project region. The SEAFRAME tide gauge network has an important role in real time tsunami monitoring and contributes toward the tsunami warning system for the Pacific Ocean.

**Figure 10. Historical Tsunami Events in the Pacific and Eastern Indian Ocean. Circle size indicates earthquake magnitude and colour indicates tsunami intensity.**

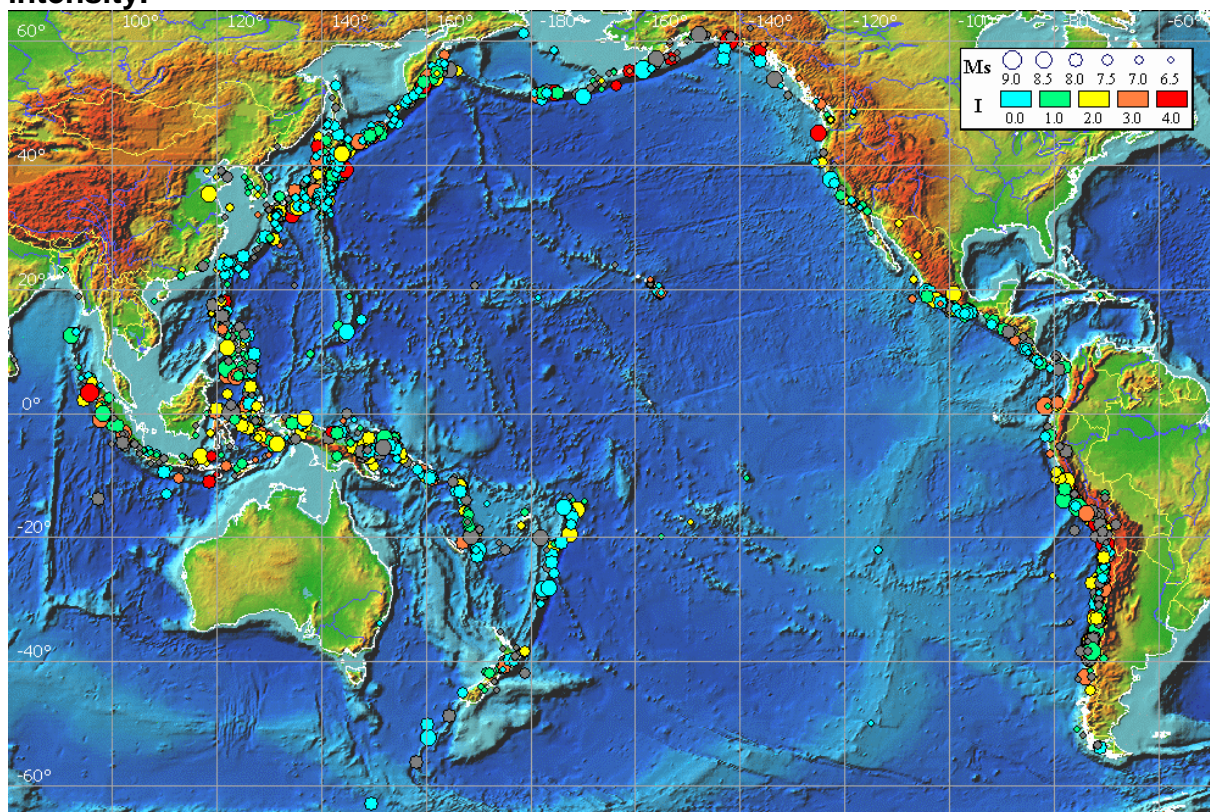

The historical record reveals few reported tsunamis have been observed at Tuvalu. Figure 11 shows the inverse tsunami travel time chart for Tuvalu. This chart may be

<sup>1</sup> ITDB/PAC (2004) Integrated Tsunami Database for the Pacific, Version 5.12 of December 31, 2004. CD-ROM, Tsunami Laboratory, ICMMG SD RAS, Novosibirsk, Russia.

used to provide an estimate of the time taken for a tsunami to arrive at Tuvalu from any source location.

**Figure 11. Inverse Tsunami Travel Times (hours) for Tuvalu.**

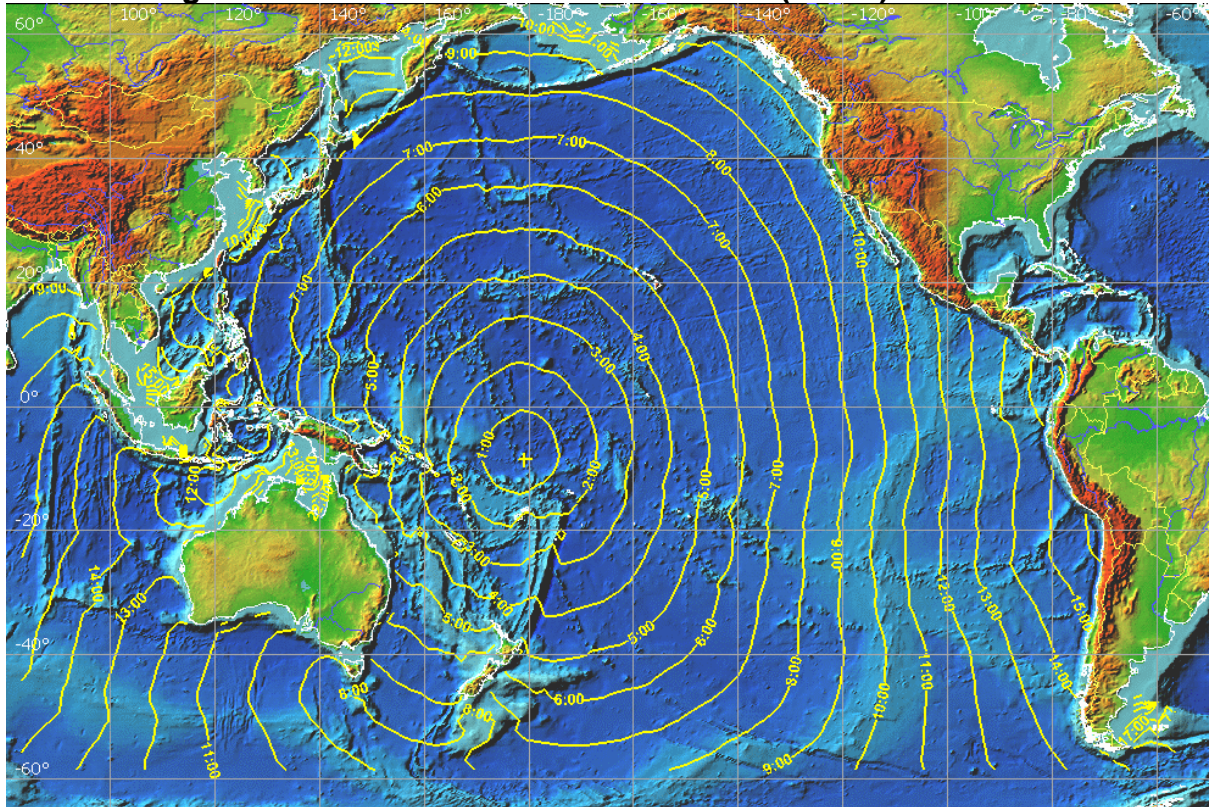

In June 2001 a tsunami generated off the coast of Peru following a magnitude Mw8.4 earthquake was detected at a number of SEAFRAME sites including Vanuatu, Tuvalu, Fiji, Samoa, Tonga and Cook Islands. At Tuvalu the amplitude was about 6 cm (Figure 12).

**Figure 12. The non-tidal sea level record (m) at Tuvalu following a tsunamigenic earthquake off Peru at 20:33 UTC on 23 June 2001.**

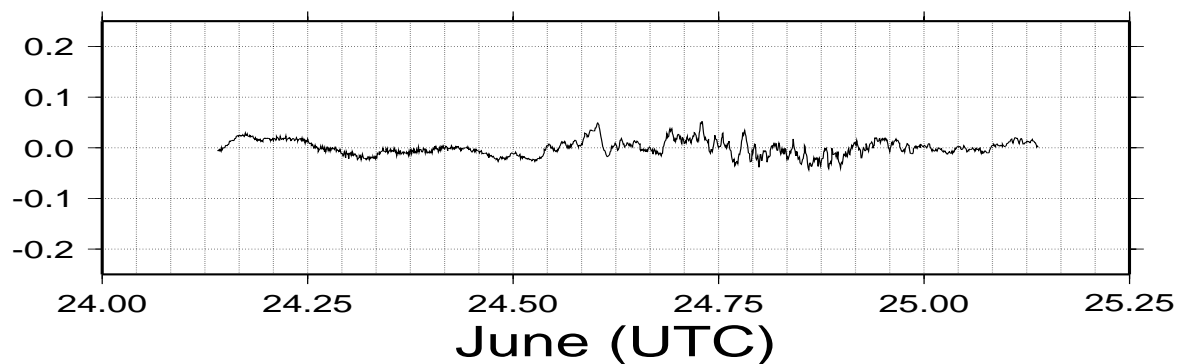

In November 1999 a tsunamigenic earthquake of magnitude Ms 7.3 occurred near

Vanuatu, causing considerable damage there. The tsunami propagated through the region. At Tuvalu the amplitude was about 6 cm (Figure 13).

**Figure 13. The non-tidal sea level record (m) at Tuvalu following a tsunamigenic earthquake off Vanuatu at 13:21 UTC on 26 November 1999.**

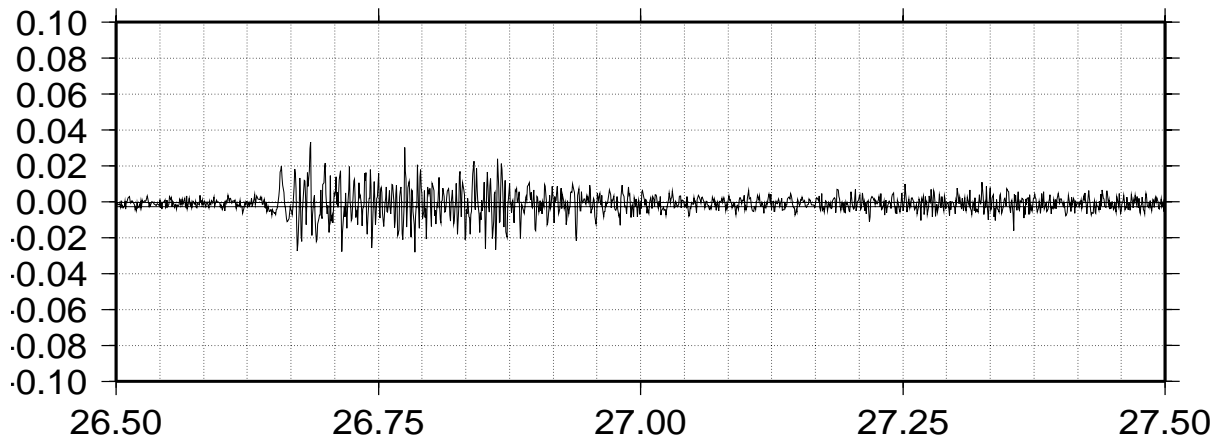

### **3.2. SEAFRAME sea level record and trend**

A fundamental goal of the Project is to establish the rate of sea level change. It has been recognised since the beginning that this would require several decades of continuous, high quality data. The preliminary findings are being provided, but caution should be exercised in interpreting this information. Figure 5 shows that confidence in trend estimates improve as more data becomes available.

As at June 2006, based on the short-term sea level trend analyses performed by the National Tidal Centre using the Tuvalu SEAFRAME data, a rate of **+6.4 mm per year** has been observed. Accounting for the inverted barometric pressure effect and vertical movements in the observing platform, the net sea level trend is **+5.7 mm per year**. By comparison, the Intergovernmental Panel on Climate Change (IPCC) in its Third Assessment Report (IPCC TAR, 2001) estimates that global average long-term sea level rise over the last hundred years was of the order of 1 to 2 mm/yr.

Figure 4 shows how the trend estimate has varied over time. In the early years, the trend appeared to indicate an enormous rate of sea level rise. Later, due to the 1997/1998 El Niño when sea level fell 35 cm below average, the trend actually went negative, and remained so for the next three years. Given the sea level record is relatively short, it is still too early to deduce a long-term trend.

The sea level data recorded since installation is summarised in Figure 14. The middle curve (green) represents the monthly mean sea level. The upper and lower curves show the highest and lowest values recorded each month. The most notable features of the monthly means are the annual peaks, which appear every year around March except in 1998, when a large drop in sea level was recorded during the 1997/1998 El Niño. Tuvaluans are accustomed to the annual peaks, which bring well-documented flooding

throughout the low-lying atoll nation. In the past decade or so, as our understanding of El Niño has improved, they also have come to expect lower sea levels during such events.

Although sea levels in the Tuvalu region normally fall in response to El Niño, the decrease that occurred during 1997/1998 El Niño can be considered extraordinary. Sea levels were lowered by 35 cm in March and April of 1998. By November 1998, sea level had completely recovered. Following the El Niño, the sea level resumed its normal seasonal cycle.

The mean sea level over the duration of the record is 2.0 m. The minimum sea level over the duration of the record is 0.53 m in February 1998 during the El Niño. Sea levels reached 3.33m in March 1997 as a result of Tropical Cyclone Gavin. The maximum sea level recorded over the duration of the record is 3.44 m in February 2006. This was not caused by a tropical cyclone, but was due to the highest predicted astronomical tide for several decades (3.24m) combined with a sea level anomaly of 0.2m due to the regional climate activity.

**Figure 14**

**Monthly sea level at Funafuti  
SEAFRAME gauge**

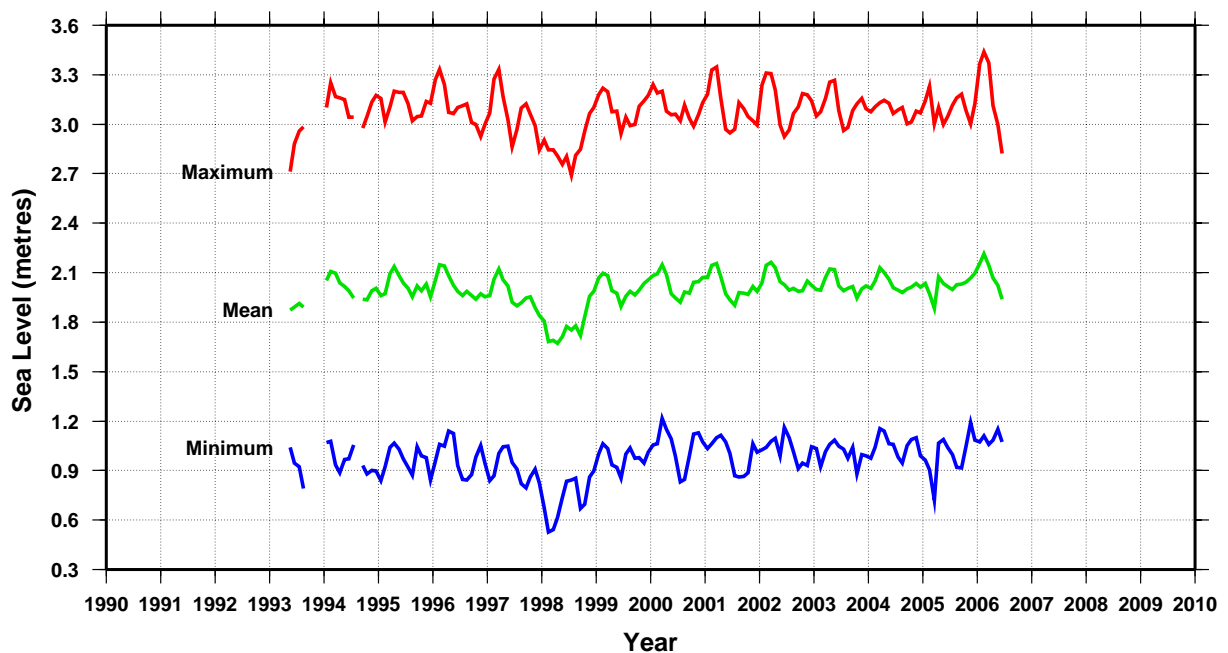

### 3.3. Additional sea level records and trend

An additional sea level record for Tuvalu is available from the Joint Archive for Sea Level, namely a 23-year sea level record for Funafuti. The monthly sea level data for this record are shown in Figure 16 and contains a relative sea level trend of +0.92 mm/year. Older tide gauge installations were primarily designed for monitoring tides and shorter-term oceanic fluctuations such as El Niño rather than long-term sea level monitoring which requires a high level of precision and datum control.

Figure 15

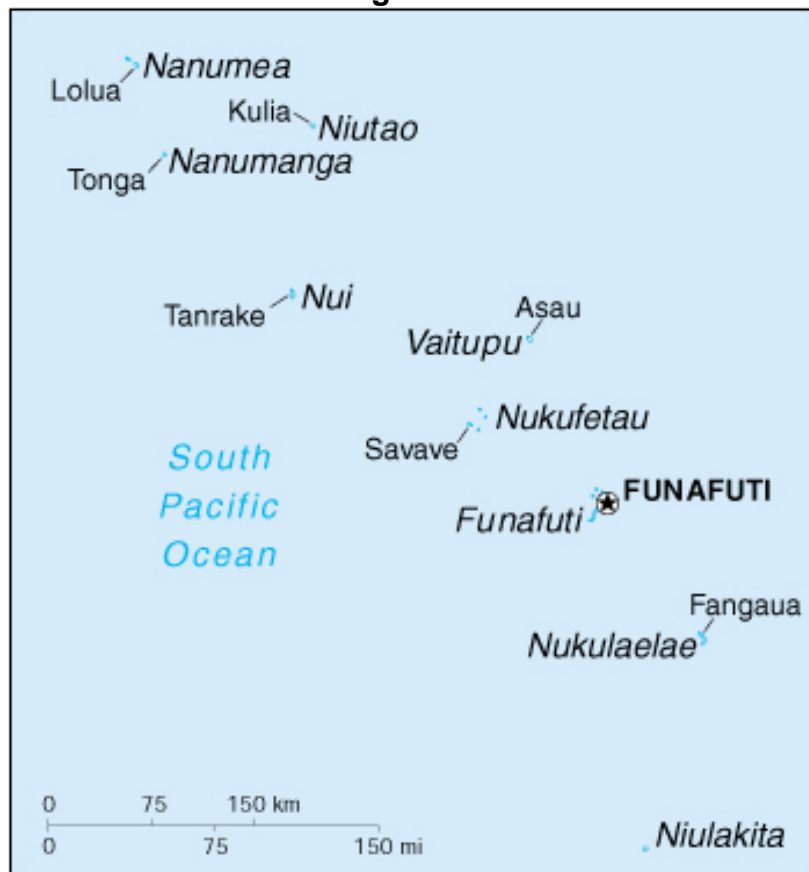
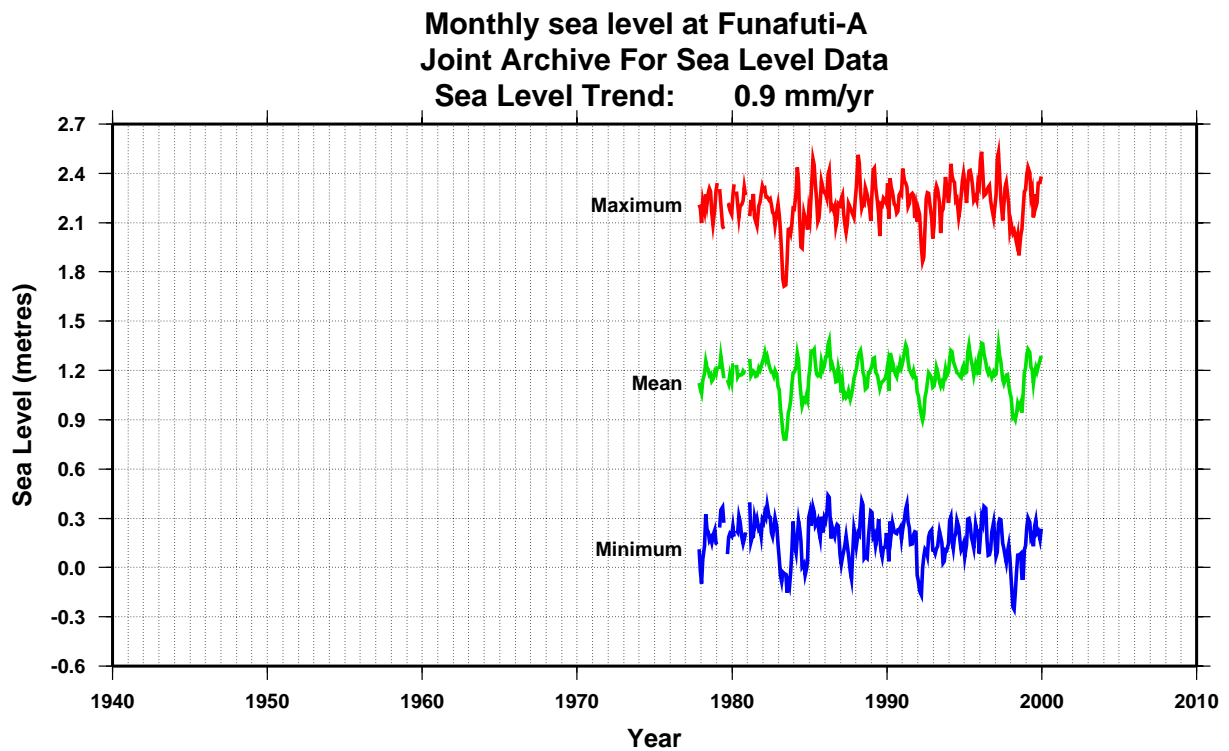



Figure 16



Precise levelling of the SEAFRAME gauge also incorporated ties to the historical gauge at Funafuti and its benchmarks. The historical gauge was sinking relative to the SEAFRAME primary benchmark by an average of about 1 mm per year. For effective long-term sea level monitoring the vertical stability of tide gauges must be monitored relative to a benchmark network that stretches a fair distance inland to stable ground. The SEAFRAME gauge at Funafuti, which is located around 3 km from the historical gauge, is considered to be vertically stable.

### 3.4. Predicted highest astronomical tide

The component of sea level that is predictable due to the influence of the Sun and the Moon and some seasonal effects allow us to calculate the highest predictable level each year. The highest astronomical tide is the highest sea level that can be predicted under any combination of astronomical conditions, including the proximity of the earth to the sun and the moon. Figure 17 shows that the highest predicted level (3.24 m) over the period 1990 to 2016 was at 17:26 Local Time on the 28<sup>th</sup> February 2006. Regional sea levels were 20cm higher than normal at the time due to climatic conditions such as enhanced trade wind activity, and so the actual sea level reached 3.44m on this day.

Figure 17

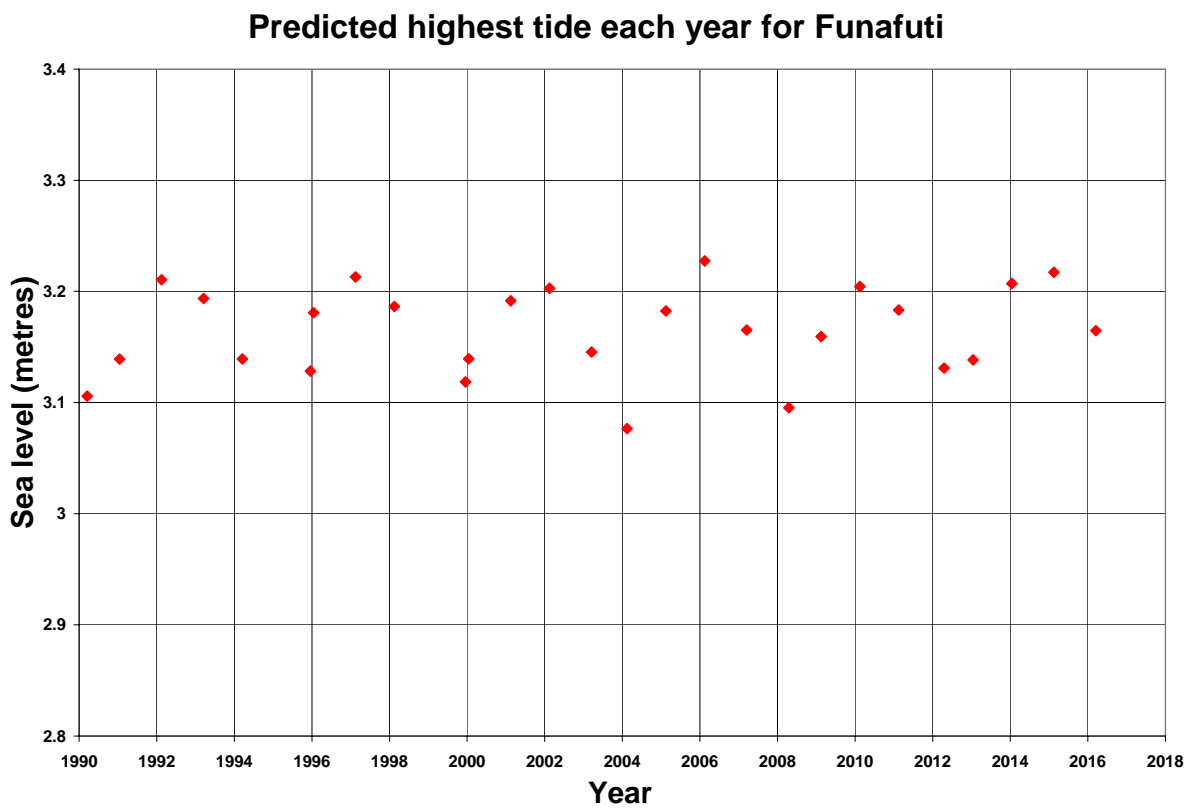

### 3.5. Monthly means of air temperature, water temperature, and atmospheric pressure

The data summarised in Figures 18-20 follows the same format as the monthly sea level plot: the middle curve (green) represents the monthly mean, and the upper and lower curves show the highest and lowest values recorded each month.

The air temperature at the Funafuti SEAFRAME gauge shows a slight downward trend in the monthly means from installation until 1999, followed by a slight upward trend. From 1999 - 2000, air temperature maxima were relatively low. The mean air temperature over the duration of the record is 28.4°C. The minimum air temperature of 22.8°C was reached in January 1999, and a maximum of 33.7°C was reached in November 2005.

Figure 18

Monthly air temperature at Funafuti SEAFRAME gauge

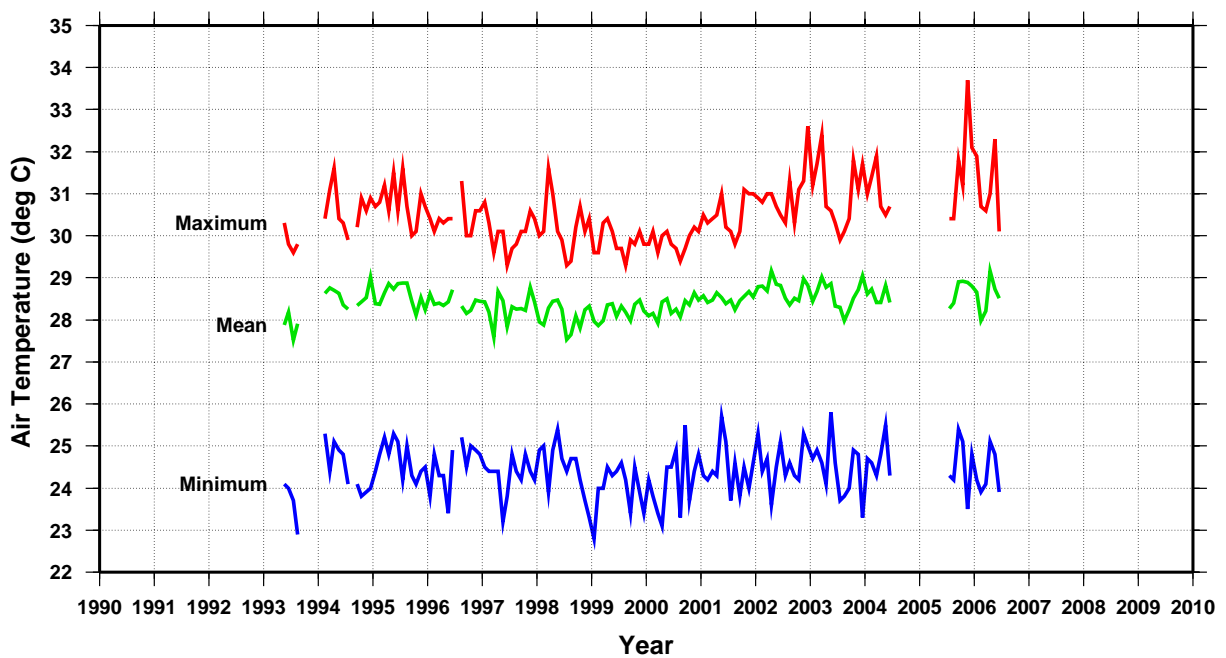

Since installation of the SEAFRAME, mean water temperatures initially declined until 1998 (the El Niño year) followed by an upward trend. The annual maximum temperatures typically occur in November each year, although during El Niño the seasonal cycle of sea level and water temperature are interrupted. The mean water temperature over the duration of the record is 29.4°C. The maximum water temperature was 32.7°C in November 2001, and the minimum was 27.6°C in July 1993.

**Figure 19**

**Monthly water temperature at Funafuti  
SEAFRAME gauge**

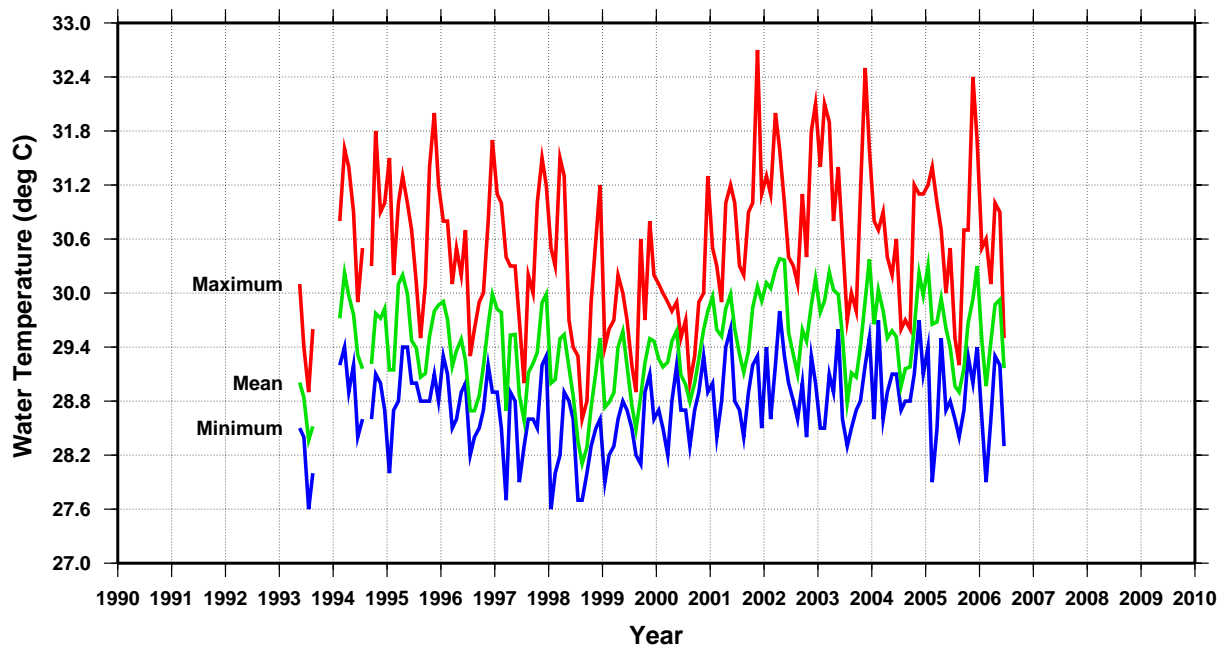

The sea level also responds to changes in barometric pressure. As a rule of thumb, a 1 hPa fall in the barometer, if sustained over a day or more, produces a 1 cm rise in the local sea level (within the area beneath the low pressure system). The monthly atmospheric pressure at Funafuti shows a decline over the years after the El Niño of 1998. The mean barometric pressure over the duration of the record is 1008.5 hPa. The highest pressure recorded was 1016.4 hPa in July 1998, while the lowest was 995.4 hPa in March 1997 coinciding with the passage of Tropical Cyclone Gavin.

**Figure 20**

**Monthly atmospheric pressure at Funafuti  
SEAFRAME gauge**

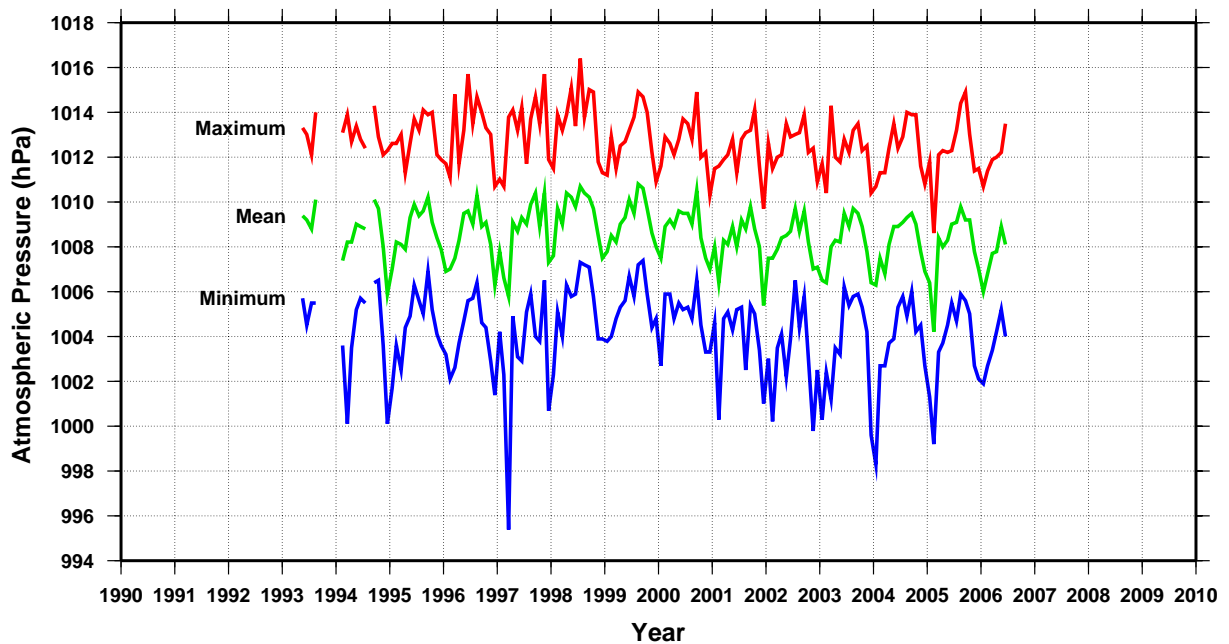

### 3.6. Precise Levelling Results for Tuvalu

While the SEAFRAME gauge exhibits a high degree of datum stability, it is essential that the datum stability be checked periodically by precise levelling to an array of deep-seated benchmarks located close to the tide gauge. For example, a wharf normally supports the SEAFRAME, and wharf pilings are often subject to gradual vertical adjustment, which in turn can raise or lower the SEAFRAME.

Precise levelling is carried out on a regular 18-monthly cycle between the SEAFRAME Sensor Benchmark and an array of at least six deep benchmarks. The nearest stable benchmark is designated the “Tide Gauge Benchmark (TGBM)”, and the others are considered the “coastal array”.

Figure 21 summarises the most important survey information being the movement of the SEAFRAME Sensor benchmark relative to the TGBM. The graph does not include the results for the other benchmarks on the coastal array. In this graph, each survey is plotted relative to the first. Thus, the second survey at Tuvalu found that the SEAFRAME Sensor benchmark had *risen* relative to the TGBM by 0.5 mm, however the Sensor level has *fallen* by 0.1 mm/year overall.

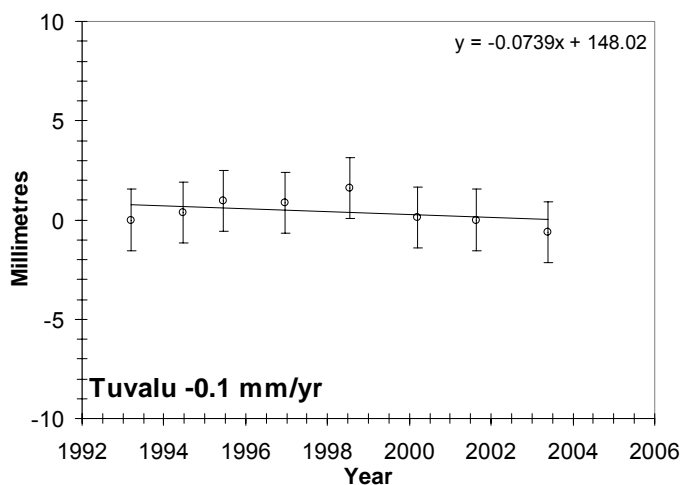

**Figure 21. Movement of the SEAFRAME Sensor relative to the Tide Gauge Bench Mark.**



**Levelling of SEAFRAME Sensor benchmark. Photo credit: Steve Turner, NTC.**

## Appendix

### **A.1. Definition of Datum and other Geodetic Levels at Funafuti**

Newcomers to the study of sea level are confronted by bewildering references to “Chart Datum”, “Tide Staff Zero”, and other specialised terms. Frequently asked questions are, “how do NTC sea levels relate to the depths on the marine chart?” and “how do the UH sea levels relate to NTC’s?”.

Regular surveys to a set of coastal benchmarks are essential. If a SEAFRAME gauge or the wharf to which it is fixed were to be damaged and needed replacement, the survey history would enable the data record to be “spliced across” the gap, thereby preserving the entire invaluable record from start to finish.

**Figure 22**

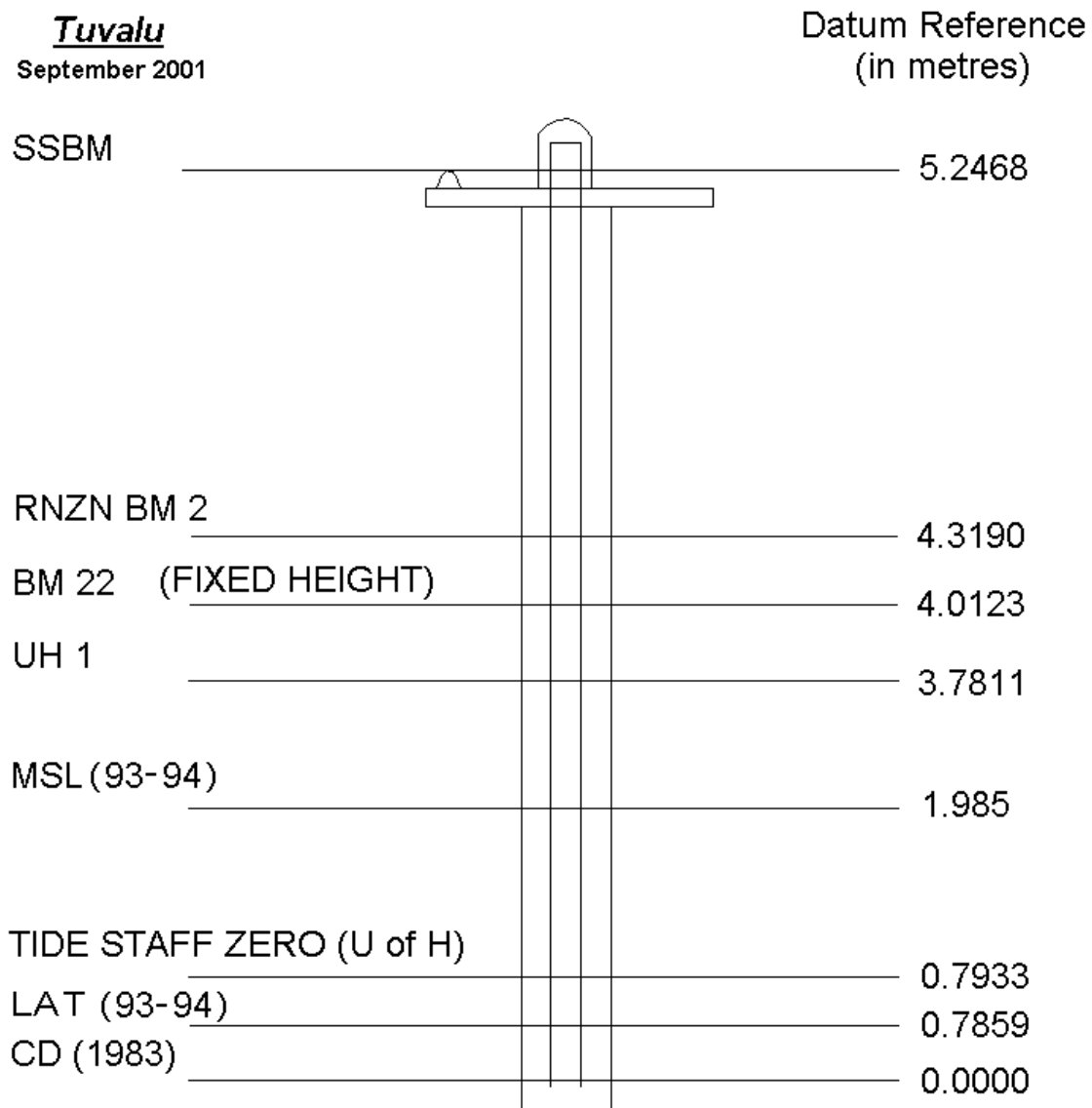

The word “datum” in relation to tide gauges and nautical charts means a reference level.

Similarly, when you measure the height of a child, your datum is the floor on which the child stands.

“Sea levels” in the NTC data are normally reported relative to “Chart Datum” (CD), thus enabling users to relate the NTC data directly to depth soundings shown on marine charts – if the NTC sea level is +1.5 metres, an additional 1.5 metres of water may be added to the chart depths.

Mean Sea Level (MSL) in Figure 22 is the average recorded level at the gauge over the two year period 1993/1994 (as indicated). The 1993/1994 MSL at Tuvalu was 1.985 metres above CD.

Lowest Astronomical Tide, or “LAT”, is based purely on tidal predictions over a 19 year period. In this case, LAT is 0.7859 metres, meaning that if the sea level were controlled by tides alone, the sea level reported by NTC would drop to this level just once in 19 years.

UH “tide staff zero” is also placed on the figure. It is 0.7933 metres, which explains why the NTC sea levels in the figure appear to be about 0.8 metres higher than the UH sea levels.

