

Nearshore fishing techniques

A manual for community fishers in the Pacific Islands



Pacific
Community
Communauté
du Pacifique

Nearshore fishing techniques

Fish & Tips

Training videos for better
and safer fishing
beyond the reef edge



Experience the perfect
complement to this
manual with Fish & Tips,
our captivating
training videos.

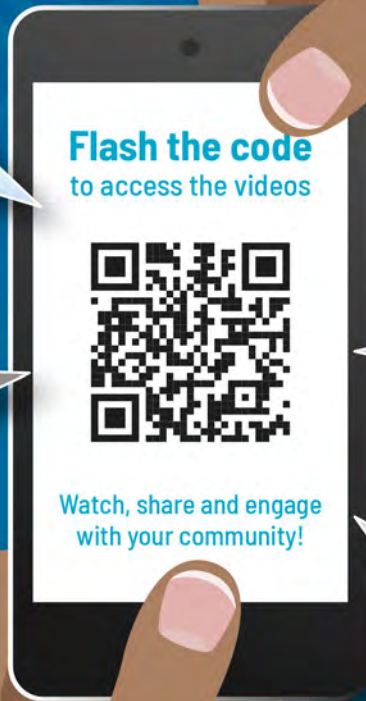

Join Pacific fishers – William, Ian, Soni, Stephanie and Kura – as they unveil the secrets of catching nearshore fish such as tunas, wahoo, mahi mahi or scads.

Access the training videos at:
<https://tinyurl.com/2hwy7pht>

Nearshore fishing techniques

A manual for community
fishers in the Pacific Islands

Ian Bertram, William Sokimi,
Garry Preston, Kim Des Rochers and Aymeric Desurmont



Pacific
Community

Communauté
du Pacifique

Noumea, New Caledonia, 2023

© Pacific Community (SPC) 2023

All rights for commercial / for profit reproduction or translation, in any form, reserved. SPC authorises the partial reproduction or translation of this newsletter for scientific, educational or research purposes, provided that SPC and the source document are properly acknowledged. Permission to reproduce the document and/or translate in whole, in any form, whether for commercial / for profit or non-profit purposes, must be requested in writing. Original SPC artwork may not be altered or separately published without permission.

Original text: English

Pacific Community Cataloguing-in-publication data

Bertram, Ian

Nearshore fishing techniques: a manual for community fishers in the Pacific Islands / Ian Bertram, William Sokimi, Garry Preston, Kim Des Rochers and Aymeric Desurmont

1. Fishery technology – Oceania.
2. Fisheries – Management – Oceania.
3. Coral reefs and islands – Oceania.
4. Fishery management – Oceania.
5. Fishing – Oceania.

I. Bertram, Ian II. Sokimi, William III. Preston, Garry IV. Des Rochers, Kim V. Desurmont, Aymeric VI. Title VII. Pacific Community

639.90995

AACR2

ISBN: 978-982-00-1519-7

Please cite this publication as:

Bertram I., Sokimi W., Preston G., Des Rochers K. and Desurmont A. 2023. Nearshore fishing techniques - A manual for community fishers in the Pacific Islands. Noumea, New Caledonia: Pacific Community (SPC). 144 p. <https://purl.org/spc/digilib/doc/z3dww>

All illustrations and cover design by Hughes Charron, SARL Eudanla, ©SPC.
Layout by Boris Colas (SPC) from an original template by Hughes Charron.

Published by:

Pacific Community
BP D5, 98848 Noumea Cedex
New Caledonia
www.spc.int | spc@spc.int

Foreword

It is my great privilege to write a few lines as the foreword to this new training manual: *Nearshore fishing techniques: A manual for community fishers in the Pacific Islands*. The focus is on sustainable fishing – targeting more productive fisheries, using widely available fishing gear, and highlighting selective techniques that will help fishers diversify their catch.

We collectively rely heavily on our blue Pacific to nourish us day to day – both physically and culturally. The art of fishing, and the necessity of catching seafood, are key themes in our culture, traditions and conversations. Many of my favourite moments in life involve the joy of sharing a fish catch with family and friends, and later sharing stories about particular catches with fellow fishers. This manual has been crafted and compiled by Pacific master fishers to help increase your chances of catching fish.

This manual intends to address the growing need to provide alternative livelihood options to Pacific Island fishing communities. As reef fisheries have come under increasing pressure, your SPC Coastal Fisheries team has developed an information toolkit that includes this manual, which describes in detail nearly 20 fishing techniques (trolling, mid-water fishing, deep-bottom fishing and catching small pelagic fish), and a series of training videos titled *Fish and Tips*. The toolkit focuses on the more resilient pelagic species and, where possible, it describes fishing gear and materials that can be found (or easily made) across most Pacific Island countries and territories.

It is the first time this array of fishing techniques has been captured in one place, making use of modern illustrations in the manual, and separate “how-to” videos. It is exciting to note that the manual is a blend of traditional knowledge and modern science and technology. Some of the methods have been used for centuries and have evolved only in the materials used, while other traditional methods have evolved based on ideas and experiences from elsewhere.

So, with a sustainable future in focus, and with a careful blend of traditional knowledge and modern technology, we wish you all tight lines and catches that feed your family!



Neville Smith

Director

Fisheries, Aquaculture and Marine Ecosystems Division

Pacific Community (SPC)

Contents

1	Background information	1
1.1	Introduction	1
1.2	Weights and measurements	3
1.3	Techniques and target species for nearshore fishing	4
1.4	Nearshore fishing safety	8
2	Boats and equipment	13
2.1	Vessel basics	13
2.2	Hand reels	14
2.3	Anchors	15
2.4	Sea anchors	18
2.5	Fishing lights	22
2.6	General equipment	23
3	Fishing gear	25
3.1	Hooks	25
3.2	Connectors, swivels and snaps	27
3.3	Ropes and lines	29
3.4	Mainlines and leaders	31
3.5	Sinkers	34
3.6	Bait and chum	35
4	Knots, crimps and splices	39
4.1	Know your knots	39
4.2	Rope knots	41
4.3	Line knots	42
4.4	Knots for hooks and swivels	43
4.5	Loop and dropper knots	45
5	Trolling basics	49
5.1	The leader	50
5.2	Matching the gear	51
5.3	Rigging trolling lines	51
5.4	Trolling with lures	55
5.5	Trolling with natural bait	57
5.6	Using chum	61
5.7	Subsurface trolling	62
5.8	Using trolling booms	67

6	Mid-water line fishing	69
6.1	Mid-water line fishing basics	69
6.2	Drop-stone fishing	71
6.3	Palu-ahi fishing	75
6.4	Cone-bag fishing	78
6.5	Spreader-rod jigging	82
6.6	Simple soft float and self-righting float drifting lines	84
6.7	Chum canister fishing	87
6.8	Ika-shibi fishing	89
6.9	Vertical longlining	92
6.10	Deep-water squid fishing	98
7	Deep-bottom fishing	99
7.1	Deep-bottom droplining	100
7.2	Deep-bottom longlining	109
8	Catching small pelagic fish	111
8.1	Flyingfish scoop-netting	111
8.2	Baitfish gillnetting	115
8.3	Baitfish jigging	119
8.4	Pencil squid jigging	122
9	After fishing	125
9.1	Care of the boat	125
9.2	Care of the fishing gear	127
9.3	Rust and corrosion	129
9.4	Care of the catch	130
9.5	Keeping records	132
10	Appendices	135
10.1	Appendix 1: Safe Operation Plans	135
10.2	Appendix 2: Five minutes that can save your life	138
10.3	Appendix 3: Further reading	142

Acknowledgements

This manual was produced with financial assistance from the European Union and the Government of Sweden through the Pacific-European Union Marine Partnership (PEUMP) programme; the New Zealand Aid Programme through the Effective Coastal Fisheries Management Project; and the Australian Government.

It draws on fisheries training materials previously published by the Pacific Community (see Appendix 3), which include contributions from Steve Beverly, Lindsay Chapman, Paul Gates, Archie Moana, Paul Mead, Pale Taumaia, Peter Watt and Paxton Wellington as well as Steve Belew, Kay Legras and Sylvia Rodgers.

The methods presented have been tested by fishers in various parts of the Pacific Islands, allowing the authors to modify and improve them. The authors would like to thank them for their help and their willingness to share their expertise.

Disclaimer

Reference to or mention of specific commercial products or brand names should not be interpreted as an endorsement by the Pacific Community or any of its funding partners. Reference to persons in any particular gender is understood to include persons of the opposite gender unless otherwise stated or made explicit by the context.

The contents of this manual are the sole responsibility of the Pacific Community and do not necessarily reflect the views of the European Union, the Government of Sweden, the New Zealand Government, or the Australian Government.



1 Background information

1.1 Introduction

What is nearshore fishing?

This manual has been written to help Pacific Island fishers increase their chances of success by targeting fish in the nearshore area. But what exactly is meant by “nearshore”?

In this manual, we have divided the ocean into three zones:

- **Inshore:** This zone is close to shore and easily reached by a small boat or canoe, or even on foot. It is where people can catch fish, shellfish and marine plants with very basic gear.
- **Nearshore:** The nearshore zone starts from outside the reef or lagoon, and goes out to about 12 nautical miles (nm), where the ocean is at least 500 metres (m) deep. This zone is reached by medium-sized fishing boats up to 12 m long, and which can carry out fishing trips that last a few days.
- **Offshore:** This zone starts at 12 nm from shore and extends out to 200 nm. The offshore zone is usually fished by large fishing vessels such as longliners or purse-seiners, which carry out fishing trips that last weeks or even months!

This manual focuses on fishing techniques for nearshore waters, although many of these techniques can also be carried out in offshore waters, as long as the vessel is safe and seaworthy for that zone.

Why does this manual focus on nearshore fishing?

Long ago, Pacific Island populations were much smaller than they are today. The recent increase in human populations throughout the Pacific has led to the overfishing of fish and invertebrates, especially those that are close to cities and towns. Many Pacific Island governments and communities want to manage inshore fishery resources as a source of healthy nutrition, particularly after cyclones and other natural disasters when food supplies may be disrupted. So, Pacific Island governments are encouraging fishers to leave inshore resources alone, and instead target nearshore fish species (those that are found beyond the reef edge). Government aid may be available to fishers who do this, and could include financial assistance, cheap (or free) fishing vessels, fishing gear, safety equipment and anchored fish aggregation devices (FADs), and help with marketing fish catches. All of these activities help to move fishing away from the inshore zone and into the nearshore zone.



The nearshore zone starts from outside the reef or lagoon, and goes out to about 12 nm.



Fish aggregation devices improve fishing performance and sea safety.

Fish smart: Follow the rules and regulations

Most Pacific Island countries have rules or regulations to ensure that fish are able to grow up and become big enough to breed and restock the ocean for future generations.

For inshore resources, rules and regulations might include:

- closed areas and closed seasons;
- size limits;
- bans on harmful gear that leaves very few fish behind (poison root fishing, scuba spearfishing or limits for gill net mesh sizes);
- bans on using destructive fishing methods (e.g. dynamite or bleach); and
- catch quotas or bag limits.

For nearshore resources such as fish, crabs, sea cucumbers and other marine animals, other rules might include:

- getting a fishing licence, if it is required;
- not allowing vessels above or below a certain size to fish within 6–12 nm of the coast;



Discussing community-based fisheries management options.

- using the right boat for the right purpose – flat-bottom boats are not recommended for nearshore fishing;
- having onboard safety gear and communications equipment, and ensuring your vessel can handle the sea conditions;
- following the rules about releasing protected species such as turtles and sharks.



Part of an information poster produced by SPC to improve knowledge of fishery regulations.

Specific rules and regulations vary from country to country, so it is important for you to know which rules apply. Although fishery regulations may seem restrictive, it is important that all fishers follow these rules; not only to ensure that fishery resources continue to benefit our children and grandchildren, but also because breaking these rules can mean big fines and confiscation of fishing vessels and gear.

Find out the main rules and regulations for your country on the Reeflex database on the Pacific Community's website: (www.spc.int/CoastalFisheries/Legislation/main).

Community-based fisheries management

The islands and atolls of the Pacific are scattered over large areas of the ocean, which makes it difficult to enforce fishery regulations. Traditional ownership and user rights of inshore areas enable communities to take the lead in managing fishing activities in their own areas. More and more, communities are becoming

involved in what is now called community-based fisheries management, or CBFM.

CBFM arrangements and plans generally include national laws and regulations, but also a community's own agreed rules, such as closed areas or seasons, species restrictions, gear restrictions, and bans on fishing during fish spawning times and places of aggregation. These rules may be set informally through community decisions, or be backed up by local bylaws.

This manual helps to support CBFM initiatives that try to manage inshore fisheries by helping communities and fishers obtain food and income from the more abundant and resilient nearshore resources. The Pacific Community has produced a wide range of other information materials about CBFM that can be found on SPC's website at <https://fame.spc.int/resources/documents>

1.2 Weights and measurements

Metric to imperial and US conversions

In this manual we mostly use metric measurements, such as kilograms and centimetres, but some Pacific Island countries use US or imperial measurements, such as pounds and feet. The table below provides conversion information between these different units.

Nautical miles and knots

Long distances at sea are measured in nautical miles (nm), and boat speed is measured in knots (or nm/hour).

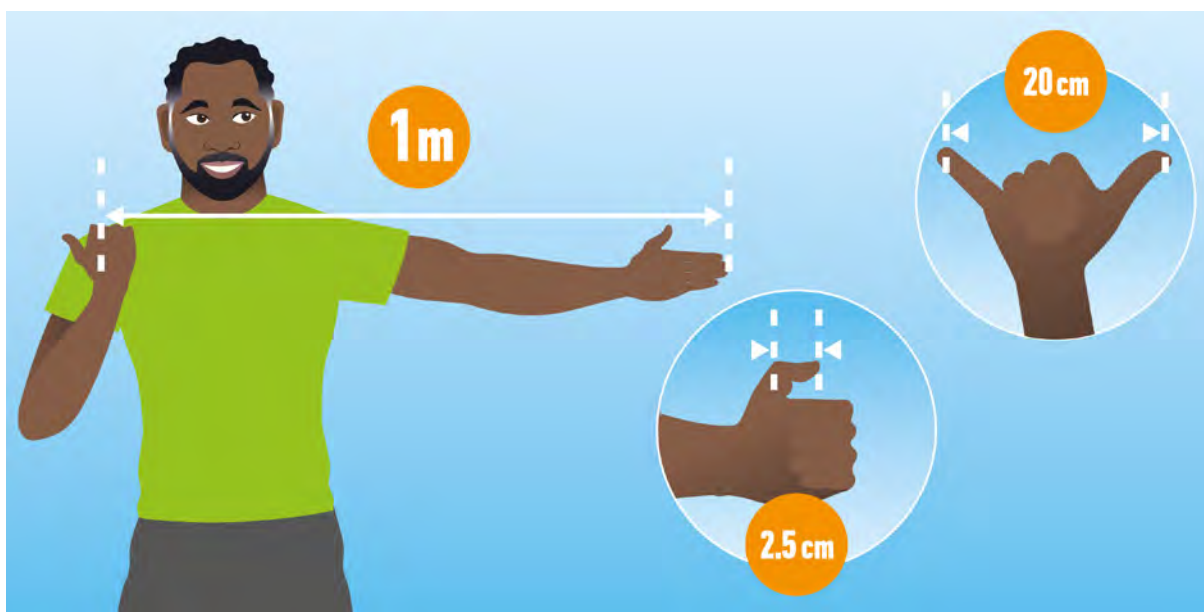

Some measurements can easily be taken using parts of the body.

Measure	Metric unit	Imperial equivalent	Conversion
Length	centimetre (cm)	inch (in)	1 cm = 0.39 in
	metre (m)	foot (ft)	1 m = 3.28 ft
		fathom	1 fathom = 6 ft or 1.83 m
Distance	kilometre (km)	statute (land) mile	1 km = 0.62 miles
		nautical mile (nm)	1 km = 0.54 nm
Weight	kilogram (kg)	pound (lb)	1 kg = 2.20 lb
	tonne (t)	imperial ton (2240 lb)	1 t = 0.98 imperial tons
		short ton (2000 lb)	1 t = 1.10 short tons
Volume	litre (l)	imperial gallon	1 l = 0.21 gallons
		US gallon	1 l = 0.26 US gallons

1.3 Techniques and target species for nearshore fishing

Fishing methods covered

This manual provides general information on vessels and gear, including fishing lines, hooks, sinkers, anchors and other equipment, as well as the main species of fish targeted in the nearshore zone.

All gear specifications given in this manual are given as a guide. They can be adapted according to the local availability of materials and each fisher's experience and preferences.

The chapters that follow give descriptions of a wide range of fishing methods used in the nearshore area, including:

- **trolling** with lures and natural baits;
- **mid-water line drop-stone**, palu-ahi and ika-shibi fishing;
- **vertical longlining**;
- **deep-water fishing** for demersal snappers and squids;
- **catching small pelagics**, flyingfish scoop netting, baitfish gillnetting or

The publication ends with three appendices, the first two being dedicated to sea safety. *Appendix 1* provides a safe operation plan (SOP) to follow when running a fishing vessel. A poster named "5 minutes which can save your life" and a "Small boat safety checklist" are reproduced in *Appendix 2*.

And finally, *Appendix 3* gives a list of manuals already produced by SPC on fishing, fish handling and fish identification techniques. This manual tries to combine many nearshore techniques into one publication.

It is not necessary to read the manual from beginning to end. The material is presented in a way that allows the reader to quickly find the information he or she wants.

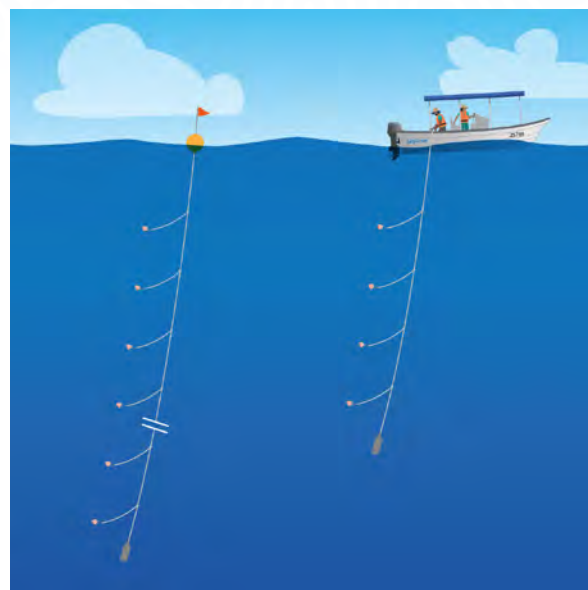

Vertical longlining

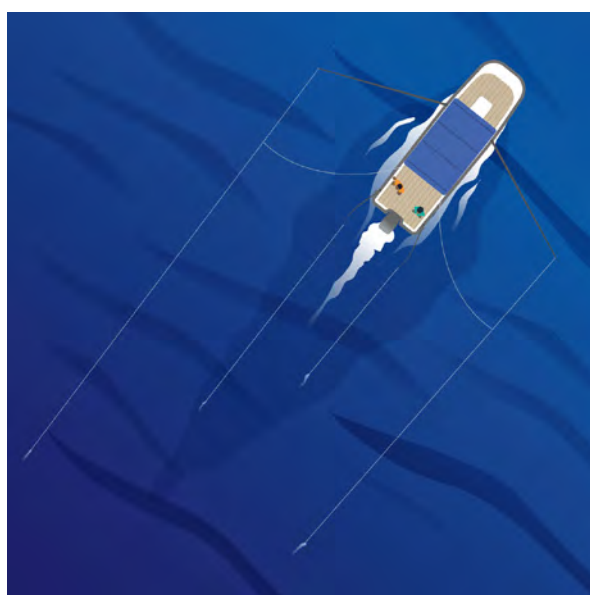

Trolling

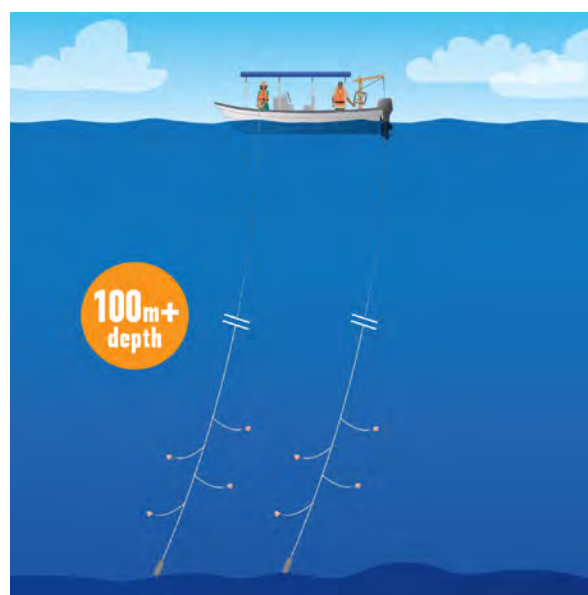

Deep-bottom fishing

Large pelagic finfish species

This manual describes fishing techniques that will help fishers to catch skipjack tuna, yellowfin tuna, bigeye tuna and albacore tuna.

These large pelagic fish are caught using many fishing methods covered in this manual, especially trolling, mid-water line fishing and longlining.

Trolling (see Chapter 5) primarily catches surface-schooling tunas such as skipjack and yellowfin, but also mahi mahi, rainbow runner, wahoo and shark. Trolling farther offshore may catch marlin and (rarely) swordfish, while fishing closer to an island's outer reef or shore may catch more barracuda, trevally, Spanish mackerel, green jobfish and dogtooth tuna.

Mid-water line fishing includes techniques such as drop-stone and ika-shibi, as well as horizontal and vertical longlining. These methods tend to take many of the same species as trolling, with the exception of skipjack, which is not common in mid-water.

Sharks are also caught by these fishing methods, often when they attack a hooked fish and end up being caught themselves.

Additional species typically caught by mid-water line fishing (especially at night) include Roudi escolar, snake mackerel and oilfish, which are also caught when deep-bottom fishing.



Skipjack tuna



Yellowfin tuna



Mahi mahi



Wahoo



Barracuda



Rainbow runner



Striped marlin

The most important large pelagic fish caught by trolling or mid-water line fishing.



Snake mackerel



Oilfish

Additional species taken by mid-water line fishing.

Small pelagic species

Smaller pelagic finfish often share the same habitat and place in the water column. These fish include anchovies, herrings, scads, mackerels, fusiliers, flyingfish, halfbeaks and silversides.

Other fish, such as long toms, small tunas and shark mackerel, fall between the large and small pelagic groupings. Others in this category include some of the smaller barracudas and some jacks and trevallies.

The sea surface fishing methods that target these species include baitfish netting and jigging (see [Chapter 8](#)), and scoop-netting, which mainly catches flyingfish. As well as being good to eat, most small pelagic species make excellent bait for larger fish.



Mackerel scad



Bigeye scad



Flyingfish

Small pelagic species

Squid

The pencil squid family includes several types of reef squids that support important food fisheries in some Pacific Islands countries. Various species occur in very shallow water such as bays and estuaries, seagrass meadows and coral reefs, down to depths of several hundred meters or more. Squid are short-lived (often no more than two years), fast-growing and have high reproductive rates. Squid stocks can be highly resilient to fishing pressure, and are thought to be less susceptible to overfishing than some fish species.

The fishing methods described in [Chapter 6](#) of this manual target the large deep-water diamond-backed squid and the neon flying squid. The methods to catch the much smaller pencil squid are described in [Chapter 8](#).



Pencil squid

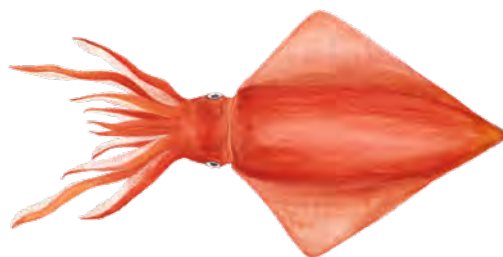

Diamondback squid

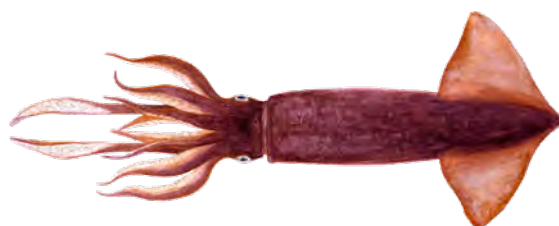

Neon flying squid

Squid

Deep-water fish

Deep-water fishing methods, which are described in [Chapter 7](#), target a wide range of deep-water snappers, emperors and groupers, as well as oilfish, snake mackerels and other species. Some of these fish are highly valuable and important for commercial fisheries, including for export.

The Pacific Community's [Fish species identification manual for deep-bottom snapper fishermen](#) includes a larger species list (see also [Appendix 3](#)).

Shark

Most of the fishing methods described in this manual will catch sharks. In some locations, sharks are caught for food, or their fins are cut off and dried for sale. Some fishers consider sharks a nuisance and try to kill them

even if they do not want them. But here is why they should not:

- Sharks play a key role in both coastal and oceanic ecosystems.
- Most species of sharks are threatened or endangered.
- International agreements prohibit industrial fishing vessels from catching or retaining certain shark species, and encourage conservation of all of them.
- Some Pacific Island countries have established shark sanctuaries or banned the export of shark products.

Pacific Island fishers should avoid catching and killing sharks whenever possible.



Ruby snapper



Pygmy ruby snapper



Long-tailed snapper



Crimson jobfish



Goldeneye jobfish



Comet grouper



Amberjack



Saddleback fusilier



Large-eye bream

A few of the deep-water fish species taken by deep-bottom line fishing.



Silky shark



Oceanic whitetip shark

Two shark species occasionally encountered when fishing at FADs.

Sensitive species

The term “sensitive species” is used in this manual to refer to fish, turtles and other marine animals whose populations and/or habitats may be negatively affected by human activities, including fishing. Some of the fishing methods described in this manual may occasionally catch sensitive species such as turtles, sharks, seabirds and even marine mammals. The Pacific Community encourages all fishers to release these animals carefully and unharmed, and has produced instructional materials showing how to do this.¹

1.4 Nearshore fishing safety

Nearshore fishing is more dangerous than fishing in inshore waters. The fishing operation typically involves heavy-duty fishing gear and big fish, which increases the risk of significant injuries. Because fishers and their vessels venture farther offshore when they are fishing in the nearshore zone – and for longer periods of time – they are more likely to experience bad weather.

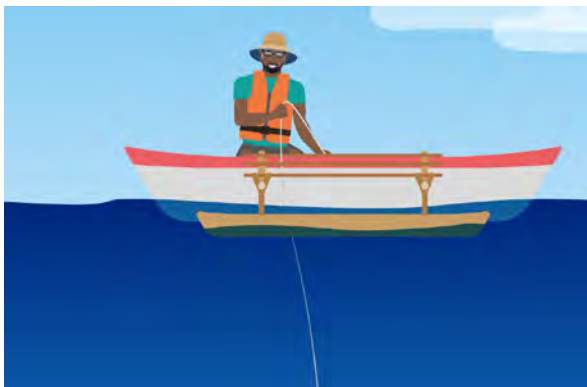

The change from traditional to motorised vessels has increased the risks of fishing operations.

This requires good boat handling skills and knowledge of basic navigation, particularly in the use of a compass or GPS (global positioning system).

Safety legislation

Canoes and small non-motorised boats that are 5–12 m long have been used in the Pacific Islands for centuries to fish in inshore, nearshore and even offshore waters. The transition from these vessels to predominantly power-driven boats throughout the region has mostly evolved in the absence of legislation for small-boat safety requirements. Most fishers phased into handling motorised boats and equipment through hands-on adaptation without any formal training or guidance.

Recently, many Pacific Island countries and territories have introduced boating requirements and crew safety regulations that reflect the treaties and guidelines of the International Maritime Organization, such as:

- compulsory and recommended safety gear and equipment to be carried on board at all times, depending on boat size or voyage type;
- maximum distance from shore or shelter, depending on type of boat (area of operation);
- minimum number of crew members on medium-sized boats (including roles and training); and
- boat construction requirements.

Such rules often exclude non-motorised boats or boats below a certain size, and may not completely apply to fishing vessels. As a result, Pacific Island countries continue to have high accident rates and many small boats go missing at sea. This has been costly to governments and catastrophic for the families who lost their loved ones.

Safe operation plan

A safe operation plan (SOP) sets out step-by-step procedures that help a fisher to carry out fishing trips safely. The SOP provides a practical checklist of safety requirements and appropriate fishing gear to ensure that the fishing operations on your boat are carried out safely and successfully. The exact form of an SOP depends on the type of boat and fishing being used. Appendix 1 shows an SOP template that can be adapted to different vessels and fishing situations.

¹ Releasing hooked turtles: <https://purl.org/spc/digilib/doc/zw2vz>
WCPFC shark and ray handling guidelines for purse-seiner and longliner crew: https://www.spc.int/DigitalLibrary/Doc/FAME/Manuals/Parts/Park_19_Shark_and_Ray_ID_Manual_Chap5.pdf



Each fisher should prepare an SOP for the type of boat and fishing operations they conduct and check it before every trip. After each fishing trip, the same form can be used to keep a record of any gear and equipment that needs repair, replacement or maintenance. The fisher should then check to make sure those issues have been addressed before the next fishing trip.

Safety preparations

Several important steps need to be carried out before setting off on a fishing trip:

- Check the forecast and make sure there are no predictions of bad weather.
- Tell family and friends where you are going, and when you will be back.



- The boat should be clean (because it was properly cleaned after the previous trip).
- Top up portable fuel tanks onshore and wipe off overflows before loading. Take care that the fuel does not enter the water. Take at least 50% more fuel than you think you will need, in case you break down or get lost, and end up farther away from home than you had planned.
- Test the engine and make sure other equipment (radio, GPS, echo-sounder) are working properly.

Ideally, every fisher should prepare an SOP (see [Appendix 1](#)) and use it as a pre-departure checklist before every trip.

As well as fishing gear, every fisher should carry safety and emergency equipment such as:

- lots of water and any food needed;
- navigation equipment (compass, GPS);
- an anchor and/or sea anchor;
- flotation devices;
- tools and supplies to repair the engine and other equipment;
- signalling devices;
- emergency propulsion, such as oars or sails;
- tarpaulin for shade and water collection; and a
- first-aid kit.



In some Pacific Island countries, boat owners are legally required to carry a basic first-aid kit. Even if a first-aid is not mandatory in your country, your fishing boat should have some first-aid supplies on board inside a water-tight container. Some of the items in your first-aid kit should include:

- aspirin or paracetamol (Panadol) for pain relief;
- sticking plasters/band-aids;
- bandages; and
- antiseptic liquid and ointment.

All gear and equipment should be loaded and stowed in an organised manner so that they can be easily found and accessed during fishing operations.

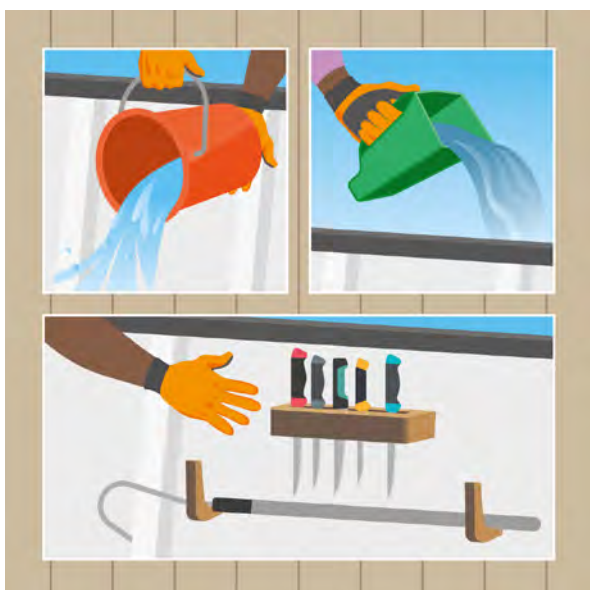
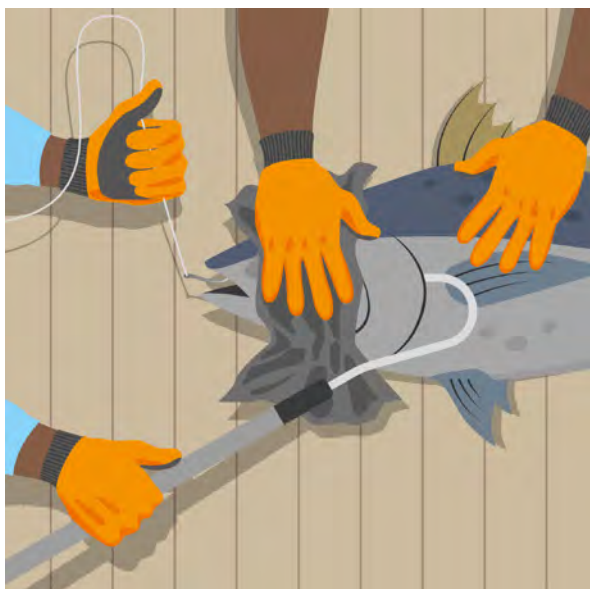

Wear gloves, keep the boat clean and the fishing gear safely stowed.

Safety while fishing

Several simple, common-sense practices will help avoid most accidents while you are fishing:

- Protect the gunwale and boat hull from line chaffing.
- Prevent fish from thrashing wildly when they are on board. Cover their eyes with a cloth, or stun them immediately with a fish club. Take extra care if there are loose hooks flying around.
- Wear gloves.
- Wash the boat down regularly. Keep the boat clean of fish guts, scales and other wastes;
- Keep the bilge clean and dry.
- Keep fishing gear organised (e.g. stow knives, hooks, gaffs and other sharp implements in safe places).

Safety and maintenance back in port

When the fishing trip is over, take the following steps to make sure your boat and equipment are ready for the next outing:

- offload fish and gear that is normally stored onshore.
- use fresh water to rinse or wipe down the boat engine, electronic equipment and fishing gear, including the trailer if needed;
- wash down the boat, fish storage bag or cooler, fish handling equipment, fishing tackle and working space so they are always clean and hygienic. Try to use solutions of vinegar, baking soda or other natural cleaning products when possible because detergents and disinfectants are harmful to marine life;
- bail, pump or drain the bilge, transom wells and areas that should not retain water;
- remove aquatic plants, barnacles and mud (silt) from the boat sides and hull, equipment, gear, and trailer (if there is one);
- inspect the boat, electronic equipment and fishing gear for damage and defects;
- repair defects before the next fishing trip; and
- stow all gear in a safe and dry place.



Emergencies

Vessel mishaps at sea can happen through unexpected or unplanned problems such as running out of fuel, a collision, swamping, engine breakdown, and other issues. Individual fishers can be injured by knife cuts, hook punctures, fish bites, spinning fishing reels, ropes, pulleys or other equipment. Line burns are a common cause of injury, especially with the growing use of small-diameter braided lines that should be handled with extra care.

Some of the emergencies that nearshore fishers may face, and steps that can be taken to avoid or minimise them, are shown in [Appendix 2](#).



2 Boats and equipment

2.1 Vessel basics

Vessel types

Fishers in the Pacific use different types of small fishing boats, and many of them are suitable for nearshore fishing. But, it is critical that any vessel used for fishing offshore be seaworthy and safe, and big enough to carry the necessary fishing gear and crew. There should also be a suitable place on board to store the catch, even if it is just in an icebox.

Boats that are 9–15 metres (m) long with deck space and some sort of cover are ideal for nearshore fishing because crew are able to stay at sea for several days. Even smaller vessels can be used for day-time nearshore fishing in situations where deep-water fishing grounds are not too far away.



Paddle canoes are used throughout the Pacific Islands.



Small outboard-powered aluminium dinghies are used for trolling, netting and handlining very close to shore.



Fiberglass banana boats are very popular and can be used for all sorts of fishing, including deep- and mid-water fishing. They are suitable for day trips only.



Cabin boats that are 9–15 m long can be used for all the fishing techniques described in this manual. They allow fishers to stay at sea for several days.

Vessel layout

Boats can be rigged and equipped in different ways, depending on the type of fishing method you use.



Cabin boat equipped for nearshore trolling, mid-water and deep-bottom fishing. Equipment includes a large icebox, a safety grab bag, a couple of floats, a gaff and fishing reels.

The boat shown in the illustration above is rigged for trolling. Other than the booms that stick out to the sides of the boat, most of the equipment can be used for the other fishing methods described in this manual.

Because nearshore fishing boats may be several miles out to sea, safety is very important. [Section 2.4](#) provides more information on the use of sea anchors for safe fishing operations.

2.2 Hand reels

Hand reels can be used for many types of fishing, and can either be handheld or mounted permanently on a boat. It is also possible to make your own hand reel (see [SPC Handbook No 25: Notes on the construction of the FAO wooden hand reel](#)).

A hand reel makes it easier to handle lines and estimate the depth of the fishing gear. By measuring the length of the line doing one turn around the reel and counting the number of turns of the reel when you pay your line out. In doing so, you can roughly determine the depth at which you place your hook(s) and bait.

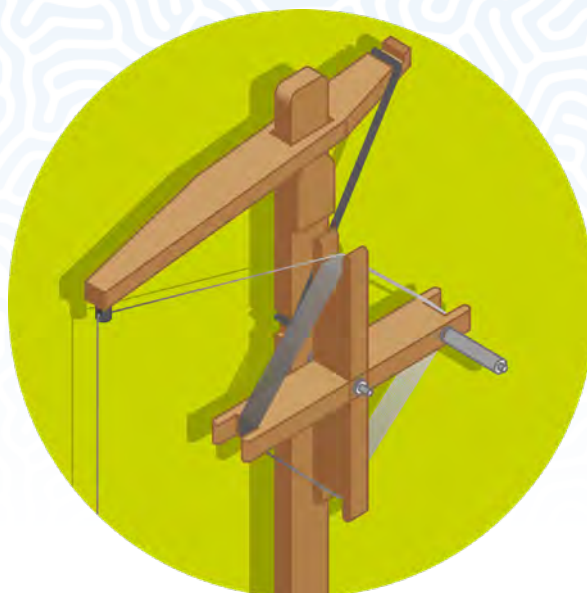

FAO wooden hand reel.

A hand reel can be mounted onto small boats as shown in the illustration below. Because these are small boats, they are only used for one-day fishing trips.

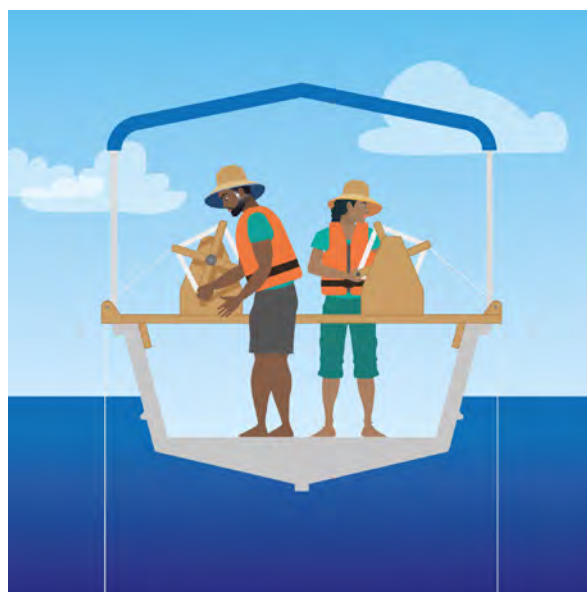

Wooden hand reels mounted on a small aluminium boat.

Commercial reels can be either manual or motorised. These types of reels make fishing easier and more efficient, but they are far more costly and are not always available. Plus, spare parts for them may be hard to come by, which makes it hard to maintain the reels.

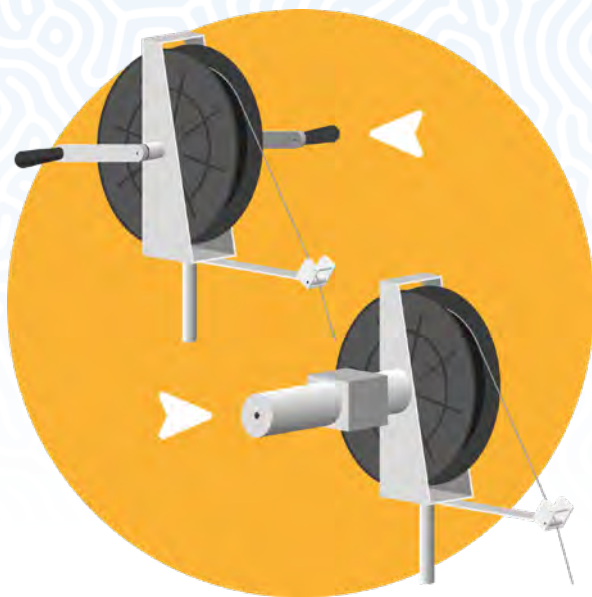

Manual (top) and electric (bottom) commercial fishing reels.

2.3 Anchors

Many of the fishing methods described in this manual are carried out in water that is too deep to anchor. In these cases, fishing is carried out while the vessel drifts freely or by using a sea anchor as shown in [section 2.4](#).

There are many types of anchors, but the best for nearshore fishing is a simple home-made anchor made of steel reinforcing rods (also called rebar) that are bent into prongs and welded or lashed together. This kind of anchor is usually made of two 2–4 m lengths of 8–10 mm

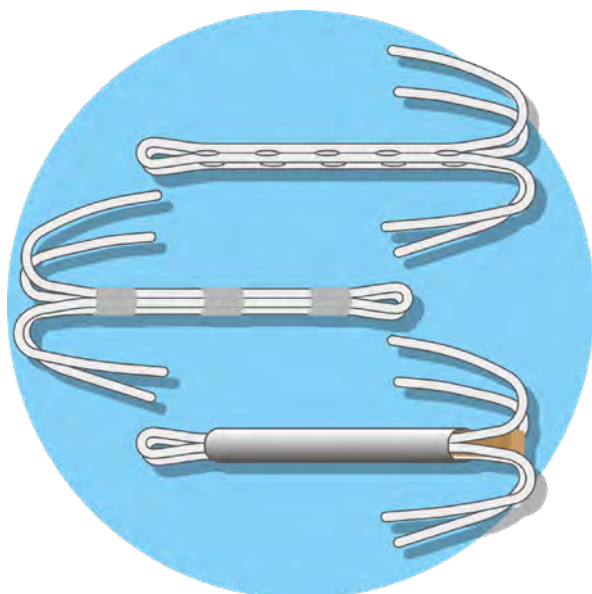

Homemade fishing anchors made of rebar.

diameter rebar. The diameter of the rebar must be strong enough to allow the prongs to straighten when the anchor is hauled up. This prevents the anchor from becoming stuck on a seafloor that has many rocks or coral rubble.

The anchor rope should be made from a material that floats, such as polypropylene, so that it will not become snagged on the bottom. The size of the rope should be adapted to the weight of the boat. For example, a 12 mm rope is suitable for an 8.5 m boat, while a 10 mm rope can be used for a smaller vessel.

The rope should be attached to the anchor by a short length (3–5 m) of chain so that the rope does not become worn out or cut by rocks on the seafloor.



A short length of chain prevents the rope from chafing on the sea floor.

If the wind is blowing your boat away from the reef, it is possible to anchor in depths of less than 100 m and fish in deeper depths. A float is attached to the anchor rope using a clip or shackle that allows it to slide freely along the rope. It acts as a shock absorber.

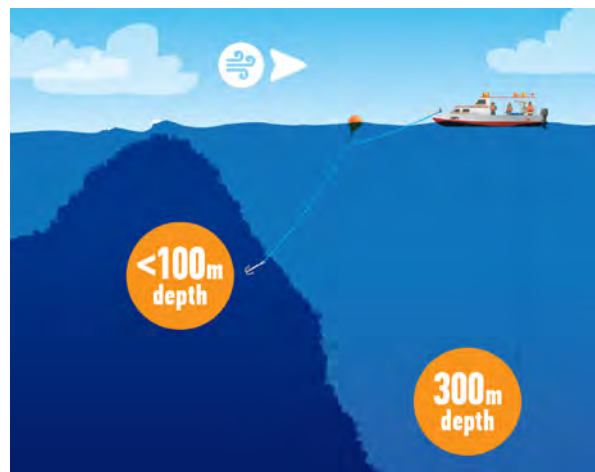

A float sliding along the anchor rope at the surface acts as a shock absorber.

Hauling the anchor up from a depth of several hundred metres is back-breaking work but can be made

a lot easier if a float is used and a non-return barb is fixed to the anchor line, close to the chain.



A float and non-return barb make hauling up a ground anchor much easier.

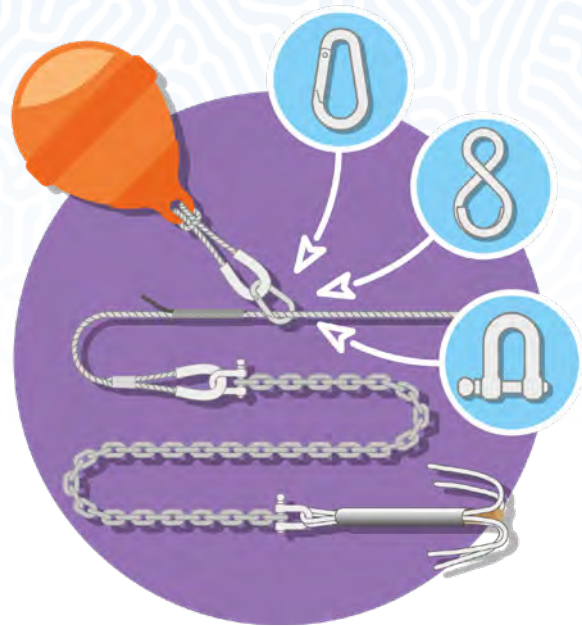

Several types of hardware can be used to connect the float, as long as they slide easily along the anchor rope.

Hauling up the anchor should be done as follows.



The end of the anchor line must be transferred from the front of the boat to the back.



The boat then motors away from the anchor so that the anchor breaks free and is hauled up to the surface...



... by the float sliding along the rope. The float eventually reaches the non-return barb on the anchor rope (about 2-3 m from the chain), which prevents the anchor from sinking back to the bottom.



The boat is then slowly turned back towards the float...



... while the anchor rope is easily hauled in.



The non-return barb prevents the chain and anchor from sinking back to the bottom.

If the anchor becomes snagged on the seafloor, the boat must be moved in different directions until the anchor breaks free.

If the anchor remains snagged, try pulling on it in different directions.



2

Once the anchor is onboard, any prongs that may have been straightened when the anchor was unhooked from the seafloor can be bent back to the correct shape.



Using a length of steel pipe helps to bend the prong back to the correct shape.

2.4 Sea anchors

Purpose

A sea anchor is useful in nearshore fishing. It prevents the boat from drifting with the wind, and instead causes the boat to move in the same direction as the ocean current. This is helpful when using vertical longlines because the sea anchor will cause the vessel to stay relatively close to the gear, which means fishers will spend less time and waste less fuel following the gear. And, there is less chance of losing the lines when they drift out of sight.

A sea anchor is also a valuable piece of safety equipment. If the engine breaks down, the sea anchor will prevent the boat from drifting too far away from its original position, which is a big help during search and rescue operations. If the boat is caught in a storm, deploying the sea anchor will help the boat to ride with its bow facing the wind and waves, thereby reducing the likelihood that waves will cause the vessel to broach, swamp or sink.

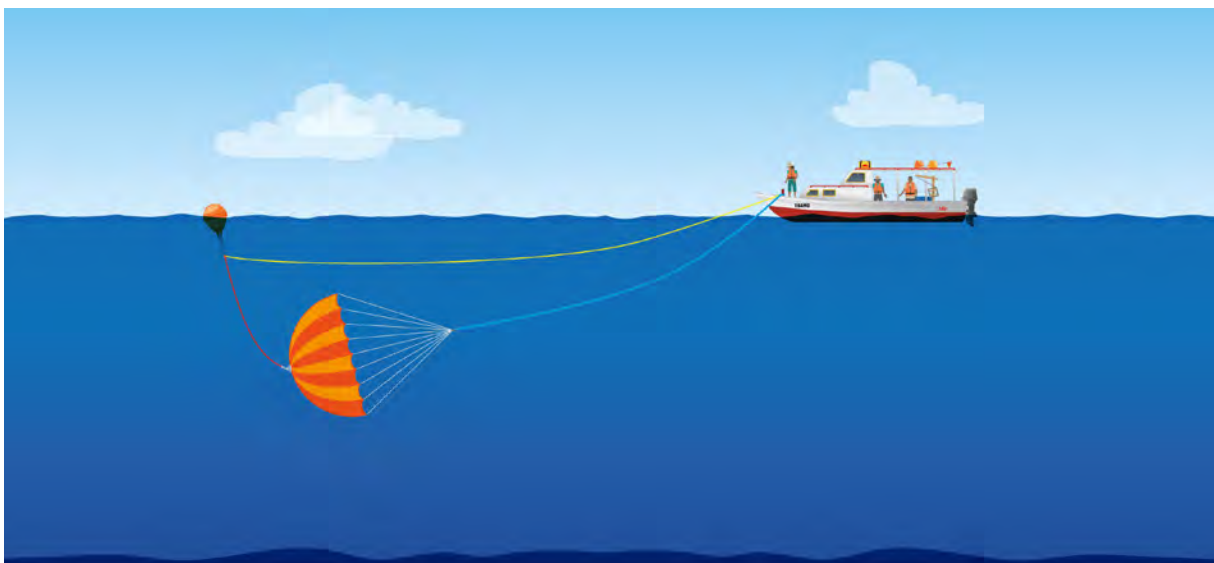

A parachute anchor

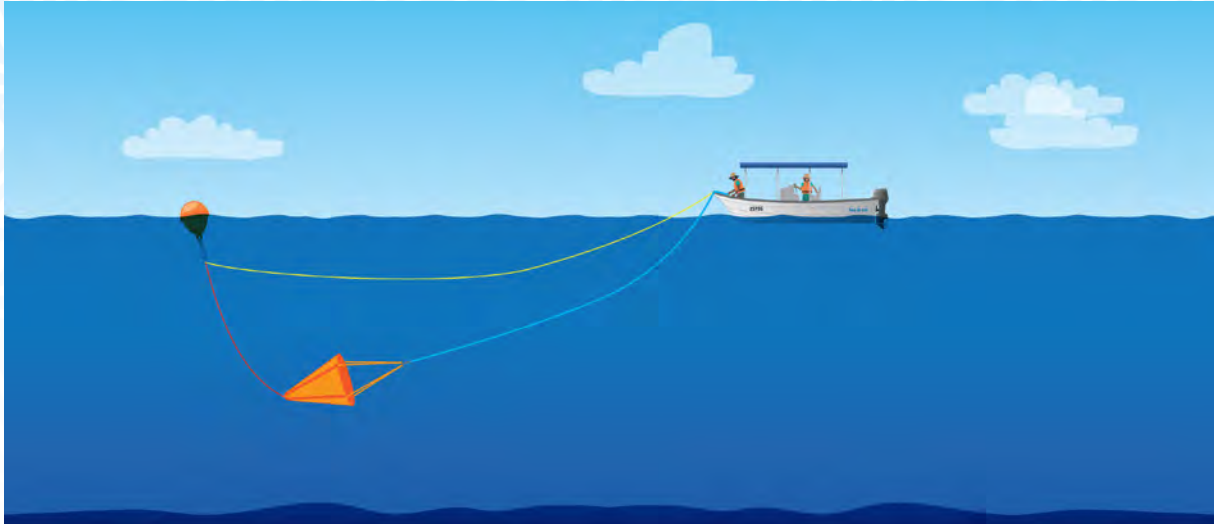

A drogue anchor

Attaching the sea anchor

Whatever size sea anchor is used, it is rigged with three main types of lines.

- The **anchor line** (often referred to as “rode”) is a length of strong rope (preferably nylon, which is stretchy and sinks) and is about 10 times the length of the vessel. The diameter of the rode is the same as that used for a normal ground anchor. One end of the anchor line is connected to the shrouds of the sea anchor, and the other end to the boat.
- The **tripline** is used to haul the sea anchor back onboard the vessel. Without a tripline, it is practically impossible to haul in the anchor due to the enormous resistance caused by

the seawater filling the parachute anchor. The tripline can be a lighter rope than the anchor line because it is not intended to take the weight of the boat. The line should be rigged with a small float to keep it at the surface where it will not interfere with the sea anchor.

- A **haul-in line** is used to recover the tripline. It should be made of polypropylene, which floats.

If possible, a large swivel should be used between the anchor line and the shrouds. The best type to use is a “dome” swivel, which is specially made for this purpose. The swivel does two jobs: 1) it stops the sea anchor from becoming twisted up while it is being used, and 2) it provides a weight to prevent the parachute from being pulled to the surface and collapsing.

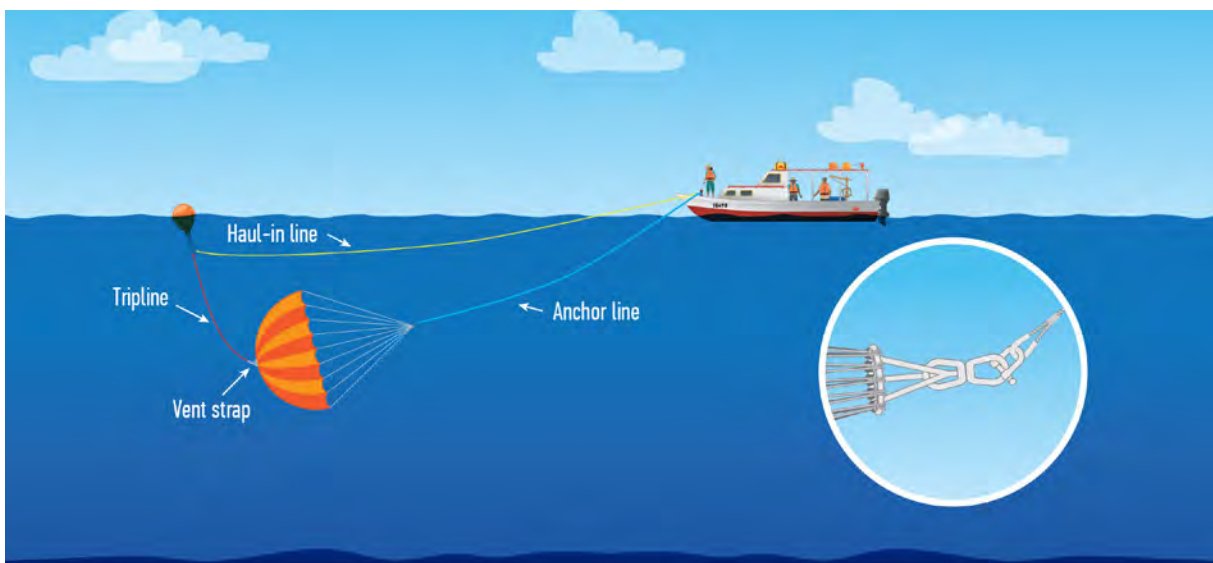

Sea anchor arrangement (shown on the left), and dome swivel (shown on right) used to connect the anchor line.

Setting and hauling in the sea anchor

To set a sea anchor:



With the boat drifting across the wind, lower the sea anchor over the bow and keep the opening of the parachute turned into the current to help it fill quickly.

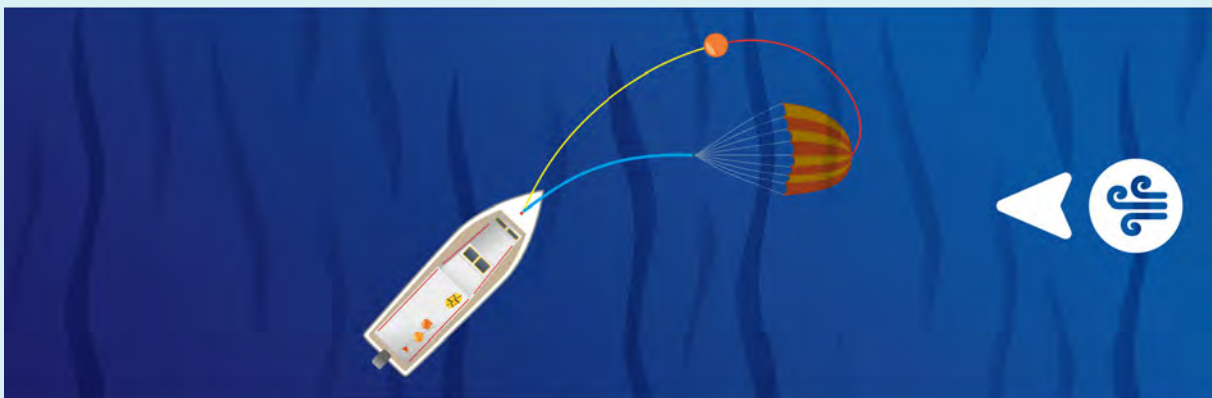

Pay out the retrieving line, tripline and float as the sea anchor fills, and allow them to float freely with no tension on the lines.

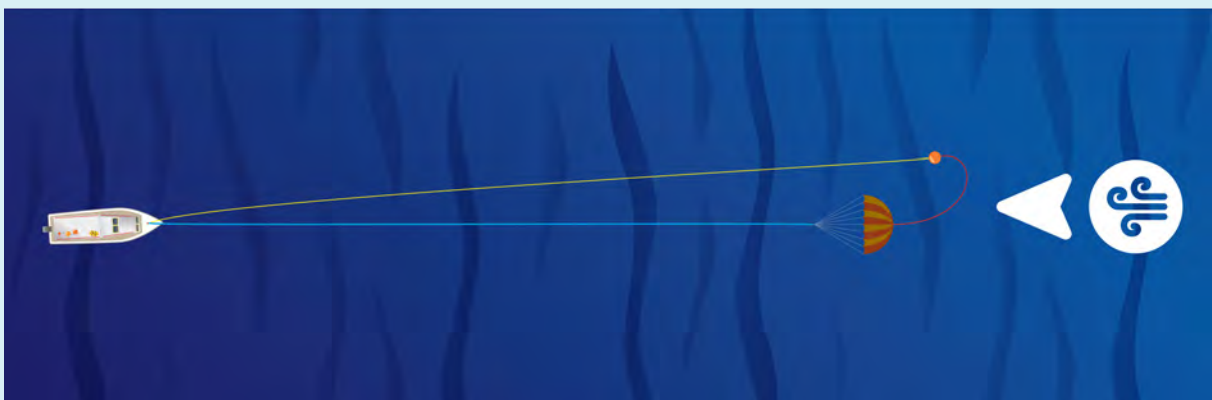

Once you feel some resistance, pay out the anchor rope until the anchor is 5-10 boat lengths away, then tie off the rope.

Setting the sea anchor can be done faster if the boat is put into reverse gear for a few seconds. An experienced crew can set a sea anchor in less than a minute and be ready to fish.

A catamaran, or two-hulled vessel, should have a bridle connection from the vessel to the anchor line, just as you would when deploying a normal bottom anchor.

To haul in a sea anchor

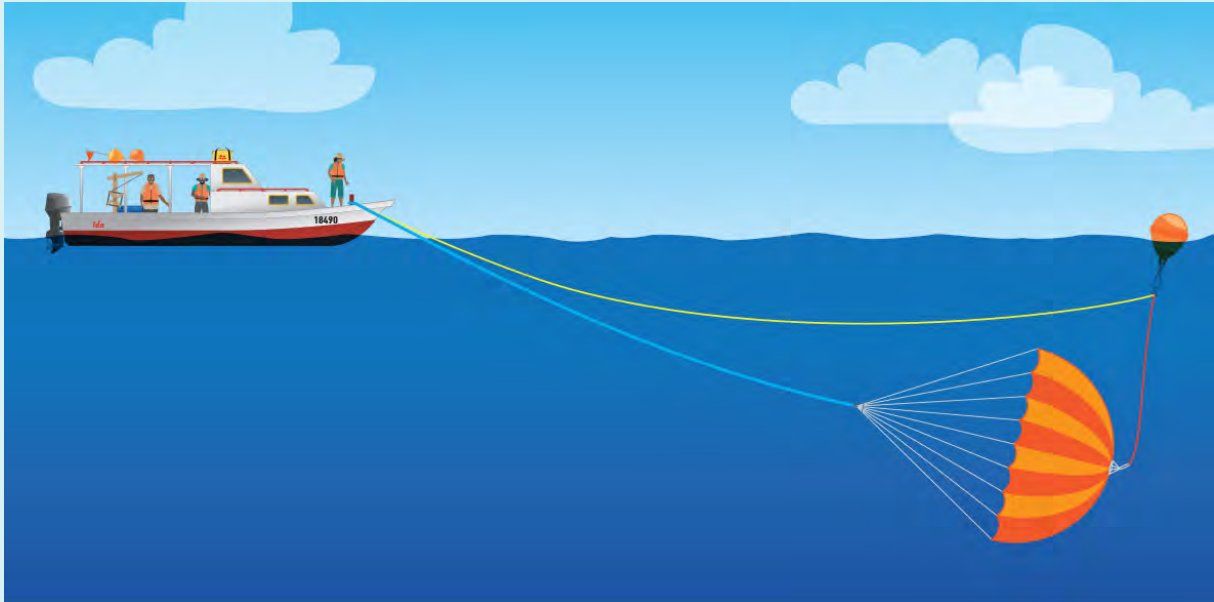

Pull on the haul-in line and...

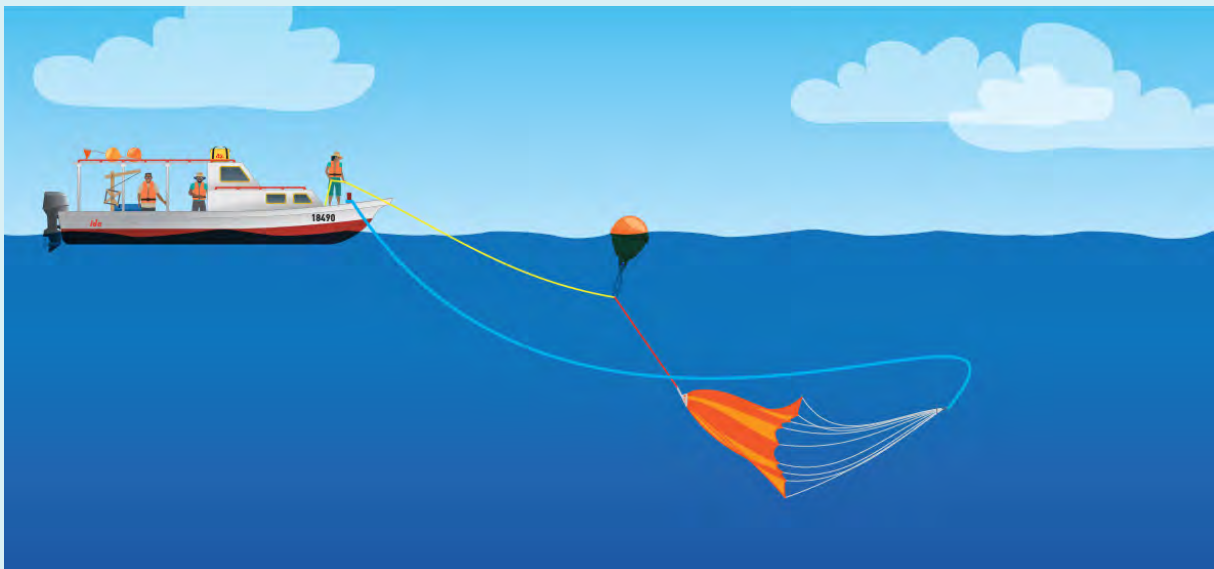

...haul in the float, tripline and vent end of the sea anchor. Then, once the sea anchor is onboard, pull in the anchor line.

2.5 Fishing lights

Lights are used in many of the fishing methods described in this manual, including ika-shibi fishing and squid jigging (sections 6.8 and 6.9); flyingfish scoop-netting (see section 8.1); and baitfish netting and jigging (sections 8.2 and 8.3). Nearshore fishing will be more successful if you have a boat equipped with lights that can be used for night-fishing. Both above-water and underwater lights can be used, depending on the type of fishing you plan to do, and the boat and equipment being used.

One way to set up onboard lighting is to wire a car headlight to a car battery using a thick electrical cable, and hang it from a high point on the boat. For underwater lighting, a 12-volt light bulb is set into a waterproof underwater light socket, or sealed into a normal socket using silicone sealant. A dimmer is usually added to the system to reduce light intensity when required.

Recently, high-powered underwater LED lights and rechargeable waterproof above-water worklights have become available. These can do the same job more effectively and are less of a fire risk on a petrol-powered boat.

When using an above-water light:

- Hang the light on a support that sticks out at least 50 cm beyond the gunwale of the boat, so that the light is shining into the water, not onto the deck.

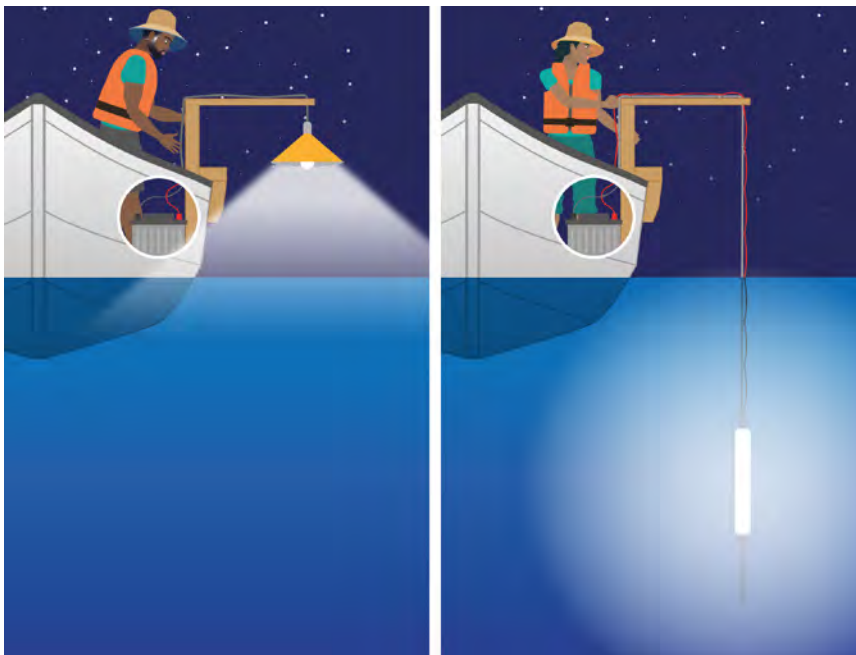

Above-water light davit and bulb shade (left), and underwater light (right).



Modern 12-volt underwater or waterproof LED lights make attracting baitfish easy.

- Some fishers hang above-water lights from their trolling booms.
- Direct the light downwards by using a light shade, plastic cone or bucket so that it does not blind you and other crew members.

If you use an underwater light, attach the electrical cable to a length of rope using twine, tape or cable ties, so that the weight of the equipment is on the rope, not the cable. Lower the light to a depth of 5–10 m and tie off the rope to a strong point on the gunwale.

2.6 General equipment

As well as the usual equipment and fishing gear already described, other essential equipment needed for fishing methods described in this manual include a sharp knife or cutting tool, gaff, club, and a way to keep the catch cool.



Filleting, cutting and blood knives. A short blood knife or drop knife is specially made for bleeding the fish by cutting the blood veins without damaging the meat.

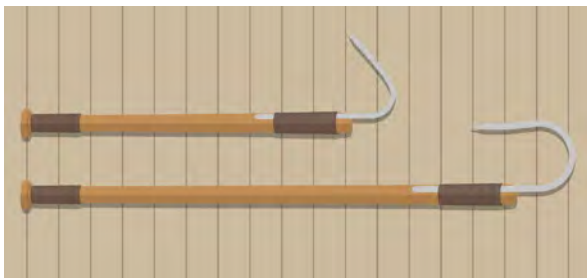

Gaffs



A fishing club or mallet to stun the fish after landing it.

Ice boxes

Whenever possible, fish should be kept on ice after being caught so they will not spoil. Keeping the catch cool is especially important for fish destined for high-priced domestic or export markets, where consumers expect the best quality for their money. A wide variety of insulated ice boxes are available in most Pacific Island locations.



Ice boxes are available in various sizes and shapes.

Insulated ice bags

These are preferred by some fishers. Bags are handy to have because they can be easily packed away or used as cushions when empty. They are also lighter than an ice box and easier to transport when full of fish.

Section 9.4 provides more information on taking care of the catch so that you can get the best price for your hard work.



Insulated ice bags are available in various sizes.



3 Fishing gear

3.1 Hooks

A hook has two functions: 1) to catch a fish, and 2) to keep a fish hooked until it is safely onboard the boat. In order to catch a fish:

- the hook must be the right shape so that the point will catch in the fish's mouth or gills;
- the hook's point must be hard enough and sharp enough to penetrate through skin and bone; and
- the shank and bend of the hook must be solid and strong enough to take the impact of a fish when it strikes the hook, and struggles to break free.

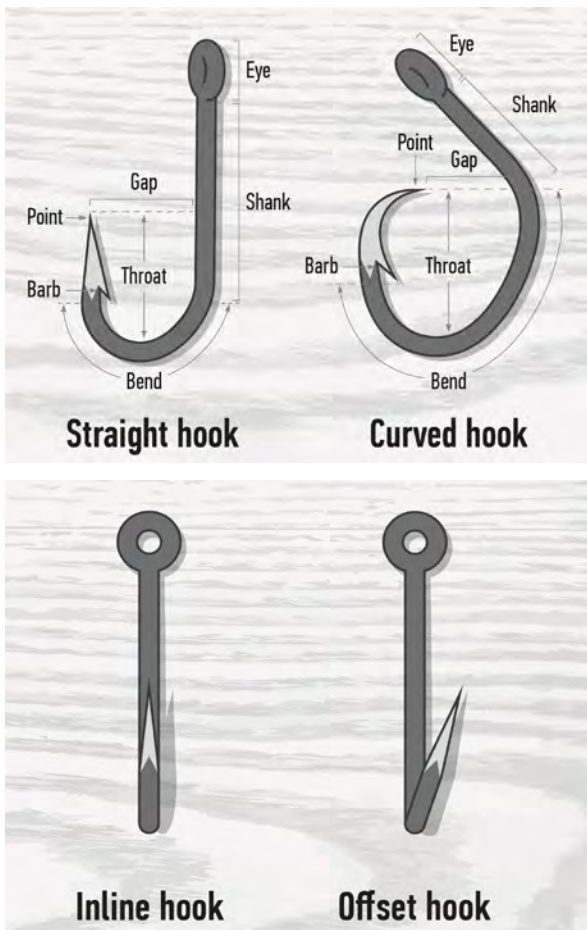

Some basic hook types.

Some hooks have an offset barb, which increases the likelihood of hooking a fish.

Besides being strong and sharp, a good hook should not rust. Hooks made of stainless steel, or ones that are chrome-plated or galvanised, are best.

Hooks come in a wide variety of shapes and sizes. Single, double and even triple hooks are used for different types of fishing.

Hooks for deep-bottom fishing

The preferred hook for deep-bottom fishing (Chapter 7) is a curved hook, like the ones shown here.

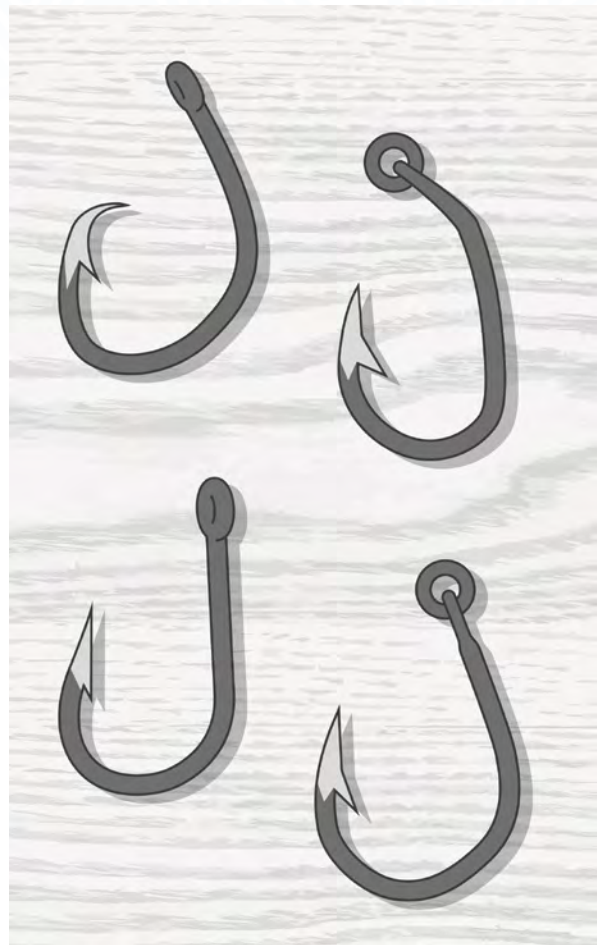

Curved hooks suitable for deep-bottom fishing.

When the fish takes the bait or pulls back, the hook rotates and catches in the corner of the fish's mouth. This type of hook is called a circle hook or "self-hooking" hook. It is a good choice for deep-bottom fishing because it is hard to feel fish bite when the hook is in very deep water.

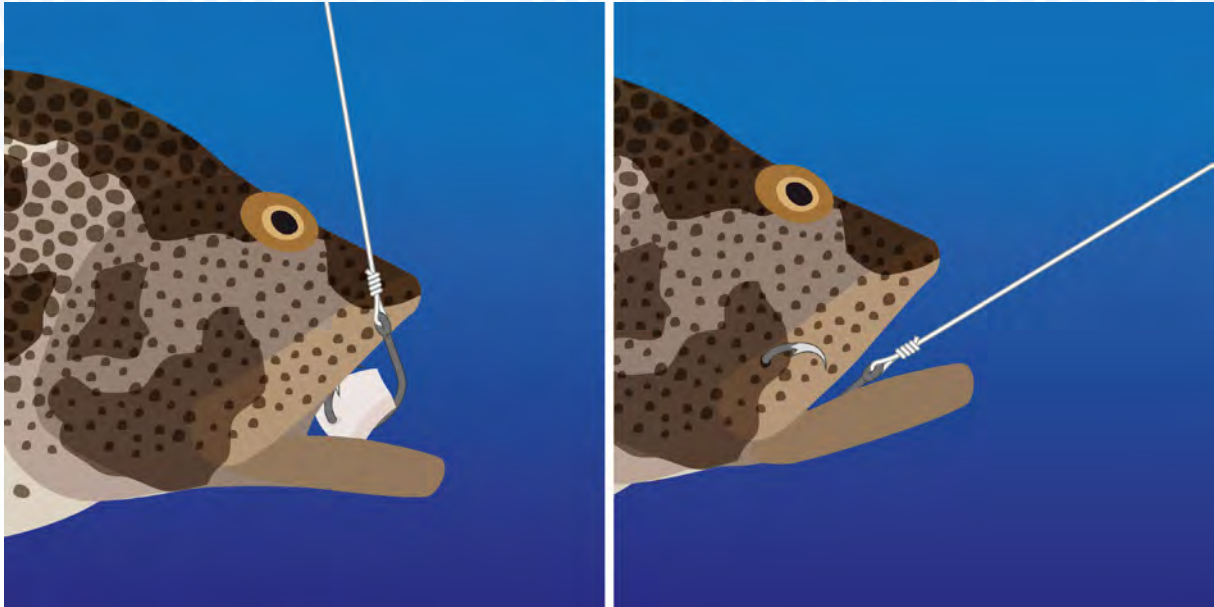

When the fish feels the point of the circle hook... any pressure will cause the hook to rotate and take hold.

As well as being effective at keeping a fish hooked, a circle hook helps prevent the capture of bycatch species, such as turtles. But, if you accidentally do hook a turtle, shark or undersized fish, a circle hook increases the chances of that animal's survival because it mainly goes through the mouth, and hardly ever goes into the stomach or guts. This makes it easier for you to unhook an unwanted species before releasing it.

Hooks for mid-water fishing and longlining

Circle hooks are also the best ones to use for mid-water fishing methods ([Chapter 6](#)). In mid-water fishing, the gear does not move and relies on the fish to hook itself, just as with deep-water fishing. In some cases, such as with drop-stone fishing ([section 6.2](#)), palu-ahi fishing ([section 6.3](#)) and ika-shibi fishing ([section 6.8](#)), the fisher may be able to yank the line at the right moment in order to set the hook, but this is not possible with longlining, which relies on the fish hooking itself.

Some circle hooks come equipped with welded steel rings inserted through the eye so that the hook can swing freely at the end of the line.

Hooks for trolling

In trolling ([Chapter 5](#)), the boat moves forward, towing or dragging a lure or baited hook through the water. Because the lure (or baited hook) is pulled quickly through the water, a circle hook does not work well, so a straight or only slightly incurved hook is better for this fishing method. Some fishers do not like offset hooks because they tend to spin when trolling.

Ganged hooks - where two or three hooks are joined together in a line by threading the point of one through the eye of the next - are used by some fishers, especially when trolling with natural bait ([section 5.5](#)).

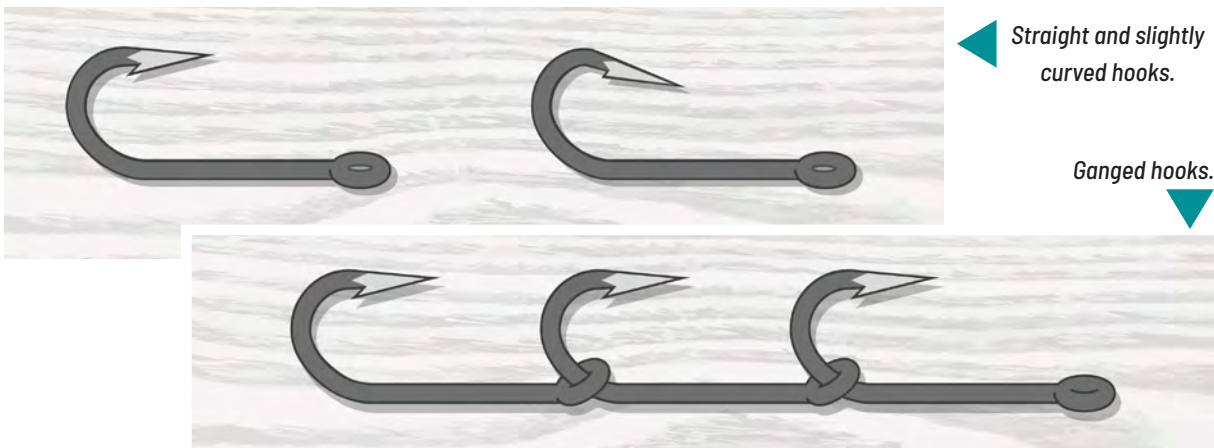

◀ Straight and slightly curved hooks.

Ganged hooks. ▼

The eyes of many straight hooks are not big enough to let the point of another hook pass through, so you may need to spread the eye a little with pliers, and then close it after threading the other hook through it. You may also need to slightly bend the eye on all but the first hook to make the gang lie in a straight line.

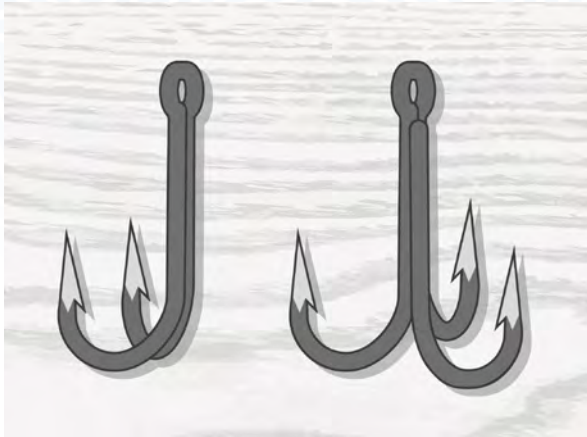

Double and treble hooks.

You can also use double hooks and even treble (triple) hooks. These types of hooks are often used with artificial lures, and many lures come already fitted with one or more double or treble hooks.

3.2 Connectors, swivels and snaps

Connectors

The usual way to connect fishing lines to one another is by using knots ([section 4.1](#)). But, there are many situations in which a line connector may be needed, including when:

- the lines are of different materials and there is a danger that one may cut or wear through the other;
- there is a danger that lures or hooked fish may spin on the line, causing twisting and tangling; and
- the line sections need to be frequently disconnected and reconnected.

Various types of connectors are available to deal with these situations.

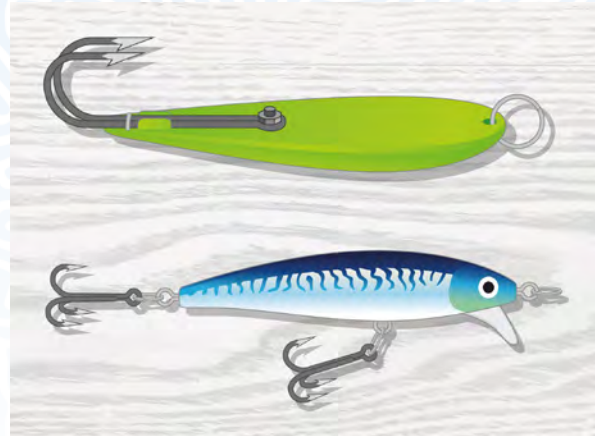

Multi-hook artificial lures.

Rings

Connector rings can be used when there is a need to join a softer line – such as monofilament nylon – to a more abrasive line – such as galvanised or stainless-steel wire.

Although they are suitable for some limited circumstances, connector rings are generally less useful than swivels and snap clips.

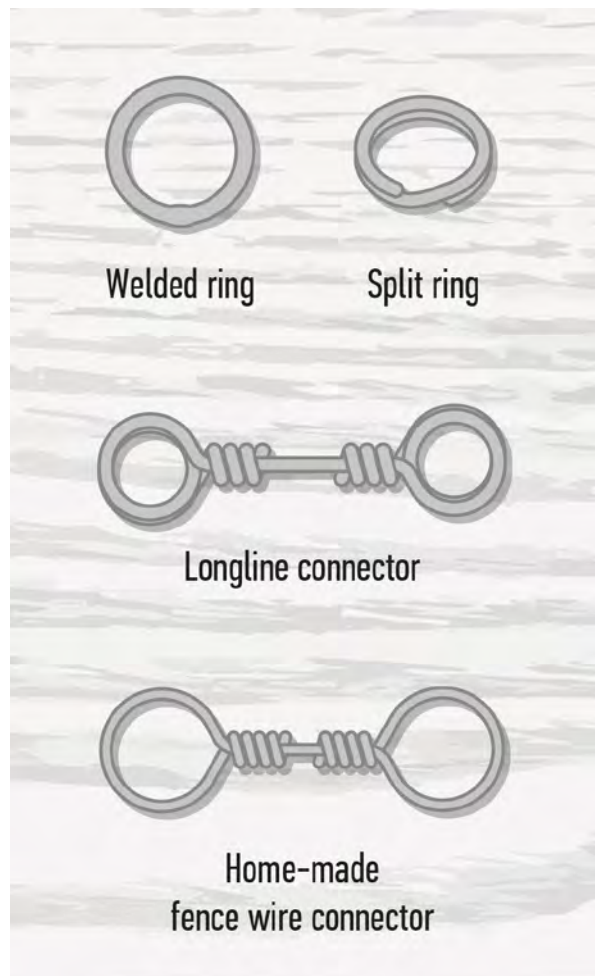

Swivels

Swivels have the same function as connector rings but can also help keep the line from twisting and tangling. There are many kinds of swivels available, as shown below.

When you use a swivel, make sure that it is strong enough for the job it has to do. The breaking strain of the swivel you use should be the same or higher than the strength of the fishing line.

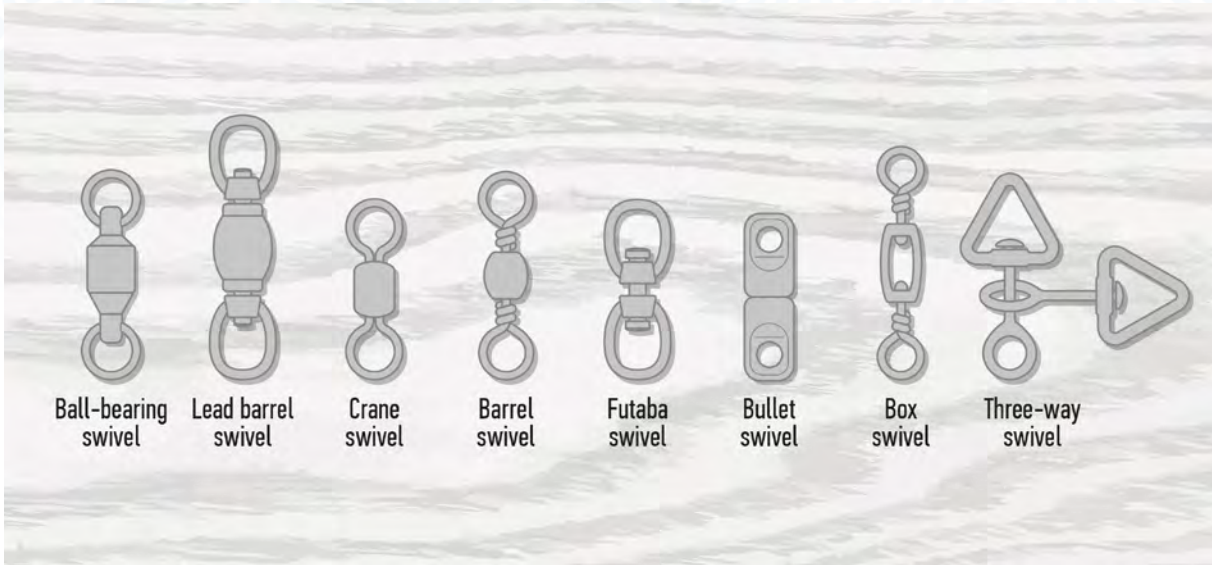

Swivel types

Snaps and clips

Snap or clip swivels are the best kind of line connector. They help prevent the line from twisting, and allow different sections of line to be quickly disconnected or reconnected. This is really helpful when disconnecting a fish and then quickly getting new bait on the line and

into the water. It is also useful when trolling, and when a fisher wants to test different lures or bait.

Connector rings, swivels and snaps can be joined to the line using the knots shown in [Chapter 4](#).

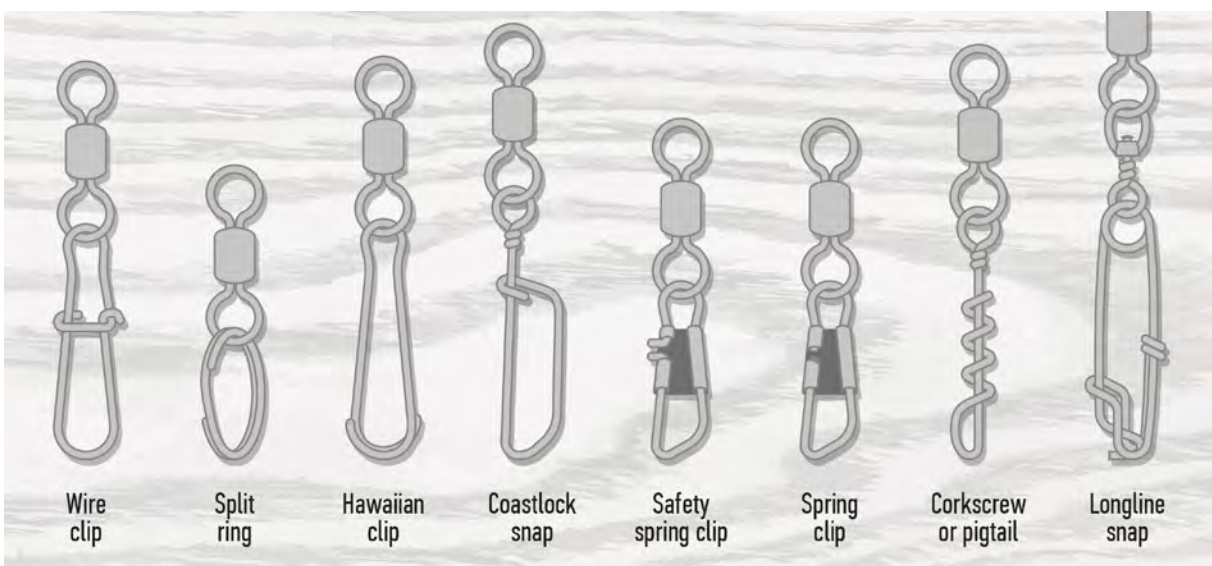

Snaps and clips

3.3 Ropes and lines

Types of rope and line

Many kinds of ropes and lines, wires and cables are used in nearshore fishing. Ropes are used for mooring or anchoring a boat, for securing gear and equipment, and many other purposes. Fishing gear may comprise several types of monofilament and multifilament lines made of different materials, including natural fibres, plastics, synthetic fibres, and metals. The main types of lines are described below.



Monofilament. This is the mostly commonly used line because it is inexpensive, readily available and hard for fish to see. Monofilament is also very stretchy (which can be good or bad, depending on the circumstances) and is less resistant to cutting or abrasion than other line types.



Twine, cord and rope. All of these are made of multifilament lines in which several bundles of fibres are twisted together. The picture shows a Kuralon™ longline rope.



Braided line. This consists of several filaments woven together, often as a sleeve around a central core of fibres. Braided line is very strong for its diameter and stretches very little. The picture above shows a braided line dyed a different colour every 10 m.



Wire. A wire is made of a single strand of metal, and is used when catching fish that can cut or bite through softer material.



Cable. A cable consists of several individual wires twisted or braided together.

Line characteristics

The table below lays out the pros and cons of the main types of line, wire and cable used in the fishing methods described in this manual.

Type of line and their main uses	Pros	Cons	
Lines	Monofilament nylon <i>Mainlines and traces/leaders</i>	Good strength for diameter. Comes in many sizes. Can easily be tied and knotted. Very elastic, sets hook well. Smooth surface, low drag in water. Usually quite cheap. Widely available. Low visibility in water.	Very easily cut. Very springy and tangles easily. Can become kinked. Smooth surface that is hard to grip, especially when wet. Knots liable to slip.
	Twine, cord or rope <i>Backing cords, mainlines</i>	Often cheaper than monofilament. Can be highly elastic. Lies flat when flaked so is less likely to tangle. Easily knotted and tied. Wide range of sizes. Easy to grip.	Very expensive. Not widely available. High drag in water. Highly visible in water.
	Soft braided lines (e.g. Dacron, Spectra) <i>Mainlines</i>	Very strong. Not elastic (good for bottom fishing). Lies flat when flaked. Resistant to abrasion and cutting. Easily knotted and tied. Easy to grip. Low drag and relatively low visibility in water.	Will tangles easily. Very expensive. Not widely available.
	Rigid braided lines (e.g. Gosen Super Toto, Sekiyama Nylon) <i>Mainlines</i>	Strong. Not elastic (good for bottom fishing). Lies flat when flaked. Very rarely gets tangled up. Resistant to abrasion and cutting. Easily knotted and tied. Easy to grip.	Very expensive. Not widely available. High drag and highly visible in water.
Wires	Piano wire <i>Traces/leaders</i>	Strong for diameter. Range of sizes available. Inexpensive. Very resistant to cutting. Can be joined without crimps. Low drag in water.	Brittle, breaks easily if kinked. Rusts. Difficult to handle. Not widely available.
	Single strand stainless-steel wire <i>Traces/leaders</i>	Strong for diameter. Range of sizes available. Very resistant to cutting. Does not rust. Usually widely available. Low drag in water.	Moderately expensive. Kinks easily. Springy and very hard to handle
Cables	Galvanised Bowden cable <i>Traces/leaders</i>	Fairly strong for diameter. Smooth surface, low drag in water. Not prone to kinking. Does not harden with use. Lies flat. Easy to handle.	Rusts. Requires crimps. May not be locally available.
	Galvanised 9-strand (3x3) steel cable (e.g. Turimoto longline wire) <i>Mainlines, Traces/leaders</i>	Strong for diameter. Usually inexpensive. Resists twisting and kinking. Can be joined with crimps.	Rusts. Fairly high drag in water. Only available in limited number of sizes. May not be locally available.
	7-strand and 49-strand (7x7) stainless steel cable <i>Mainlines, Traces/leaders</i>	Strong for diameter. Lies flat and relatively easy to handle. Moderately resistant to twisting or kinking. Many sizes available.	Expensive. May rust or corrode if used with dissimilar metals. Frays with wear, becoming difficult and painful to handle. Breaks if twisted badly.

Joining lines

It is important to know how to join lengths of rope and line together, either permanently or temporarily. There are different ways to do this, depending on the types of materials you are connecting.

- **knots** are used to make permanent or temporary connections between lines of all kinds other than wire and cable;
- **splices** are used to make permanent connections between ropes, as well as some kinds of cable;

- **twists** are used to make permanent connections in single strand wire; and
- **crimps** are used to make permanent connections between lines, especially if one or both of the lines to be joined is multi-strand wire.

These same methods can be used to attach lines to hooks, connectors or other objects, as shown in more detail in *Chapter 4*.

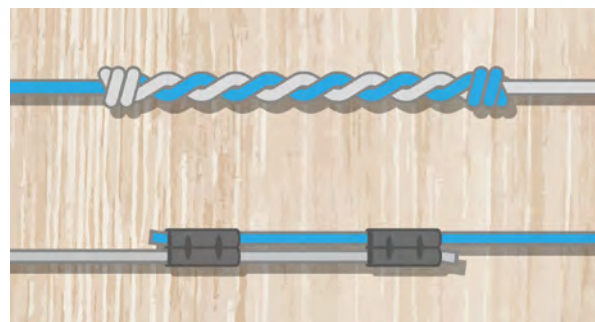
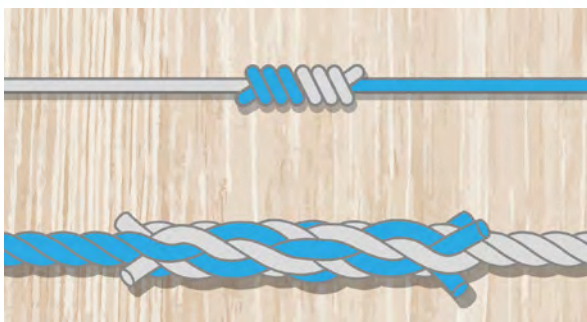

Four different ways to join lines.

3.4 Mainlines and leaders

Line components and some typical gear

The fishing gear described in this manual is made up of sections of line that are usually made of different materials.

- The **mainline** is usually the longest part of the gear, and made of strong material such as cord, braid or heavy-duty monofilament nylon. Many of the hook-and-line methods described in this manual require mainlines of 200 metres or more.
- **Branchlines** are used in some fishing methods so that multiple hooks are attached at intervals along the mainline.
- A **trunkline** is a short section of line that is joined to the end of the mainline, and has multiple hooks or lures attached on shorter branchlines.
- A **leader** (sometimes called a **trace**) is a shorter section of line that has a hook or lure at one end. The other end may be joined to the mainline, a branchline or a trunkline. In some fishing methods, leaders are attached using clips or other connectors (see *section 3.2*) so that they can easily be removed for changing or storage.
- **Floatlines** are used in some fishing methods so that buoys can be attached to one or more sets of fishing gear, which lets fishers fish independently from the boat. Clips or connectors may be used to attach floatlines to the mainline or to the float itself.
- **Backing** is a heavier line that is used – especially when trolling – to connect the mainline to a fishing reel. The backing provides cushioning between the reel and the mainline and can be joined to the mainline using a swivel, knot or splice.

The diagrams on the following page show the ways that different parts of the line are assembled in some of the fishing methods described in this manual.

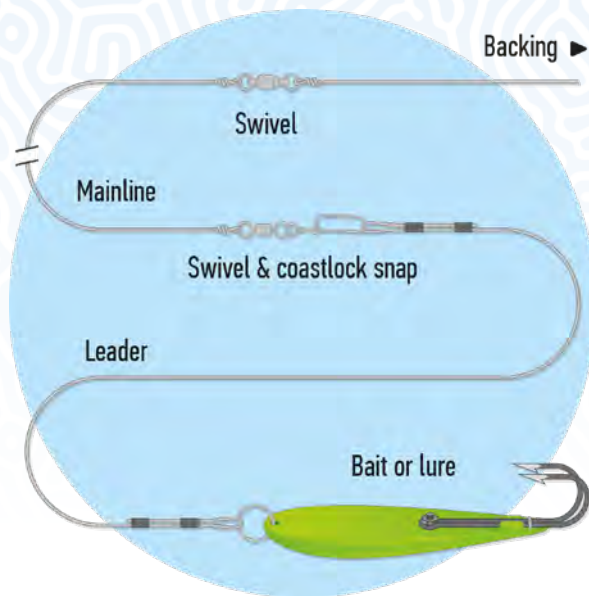

Trolling line

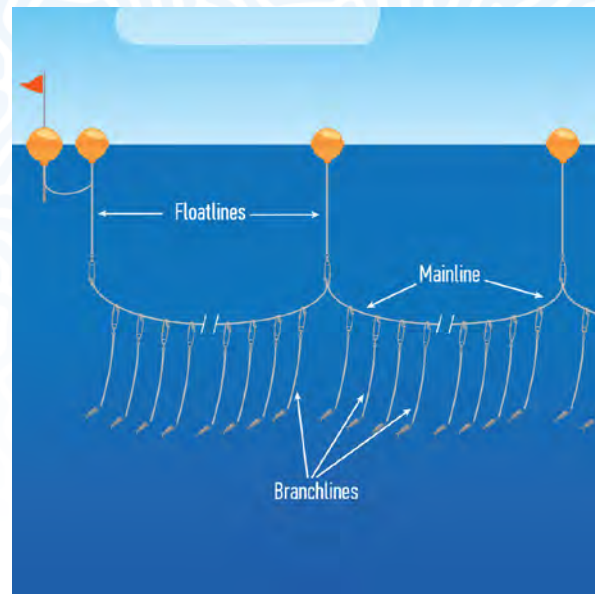

Horizontal longline

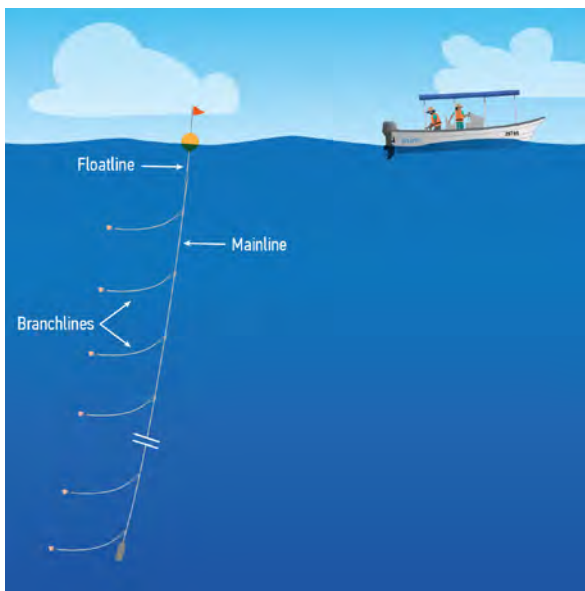

Buoyed-off single dropline, or vertical longline.

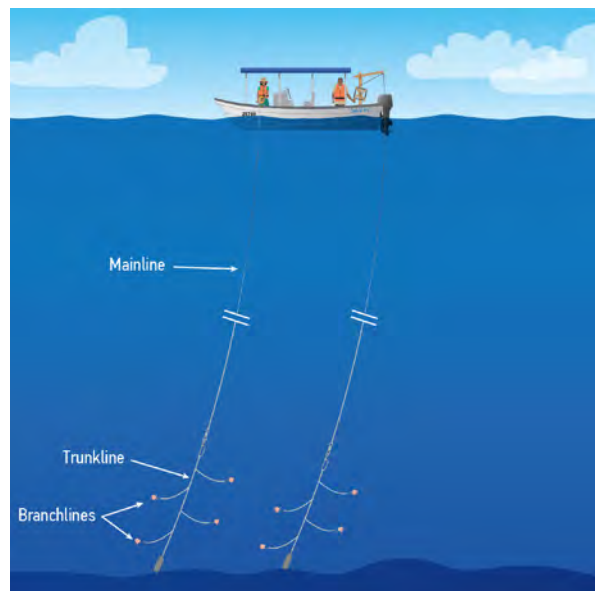

Deep-bottom fishing lines.

Trunklines, branchlines and leaders are usually weaker than the mainline so that they are the first to break under excess strain, and only part of the fishing gear will be lost.

A leader is made of material that is specific to the fishing method. For example, it may be made of wire or cable if the target species has sharp teeth, or made of low-visibility monofilament for species such as tuna or squid that have good eyesight.

Line storage

The best way to store most kinds of fishing lines is on commercially made plastic spools or hand casters. A large (30-cm diameter) spool is big enough to store one mainline or multiple traces or branchlines. Old purse-seine floats, which are often found drifting at sea, make good line spools when partially cut away to hold the line.

Avoid using flat wooden frames that will kink the lines, or old plastic bottles that are easily crushed.

If you set multiple drifting lines ([section 6.6](#)), it helps to store the mainlines in a plastic crate to keep them from tangling. This also makes it easy to rinse the lines off.

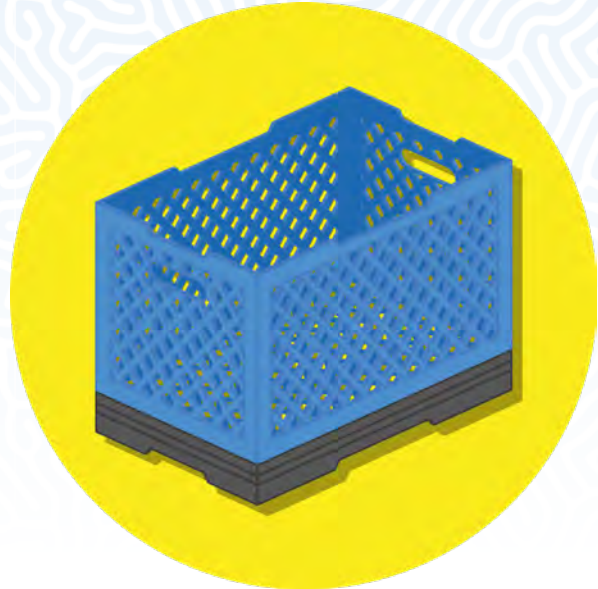

Plastic crate to store mainlines.

Plastic spools and carved-out purse-seine floats are good for storing line; wooden frames are not.

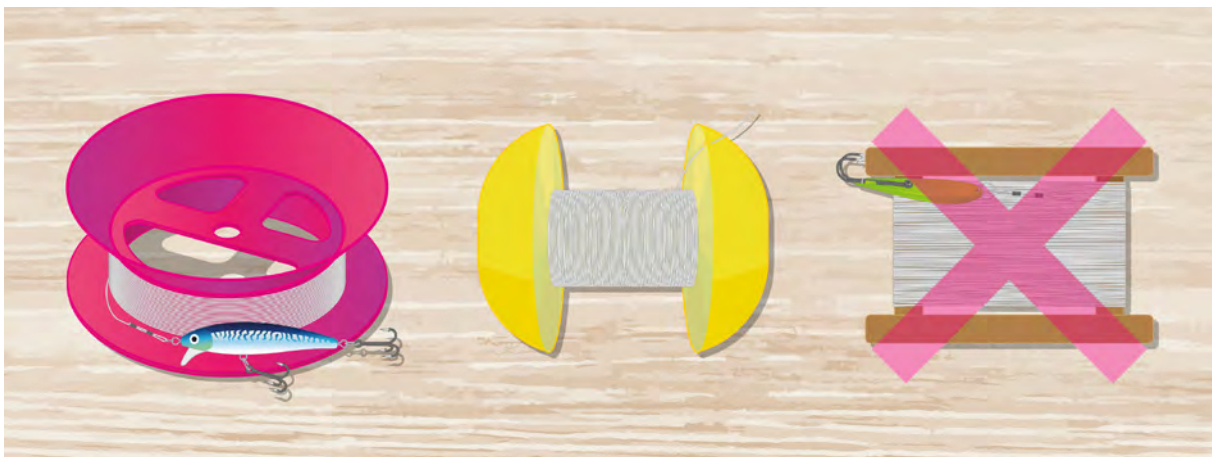

3.5 Sinkers

Most of the fishing techniques in this manual use sinkers to get the gear down to the correct fishing depth, which for some fishing methods can be quite deep.

The cheapest way to get sinkers is to make your own, and the best material to use is lead, because of its high density. A common source of lead is the plates of old

car batteries, or used wheel balancing weights, but it can also be purchased as sheet lead from a hardware store. The lead must be melted down on a gas burner or open wood fire in a small pan or ladle. Lead is toxic so avoid breathing the fumes and make sure the pan is never used for cooking food.

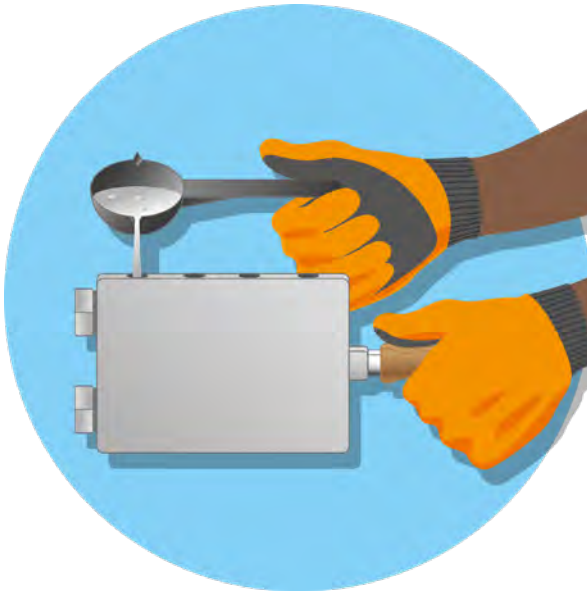

You can buy lead sinker moulds in many shapes and sizes...



...or you can make your own from wood, or even cardboard set in a bed of sand.

Sinker moulds, usually made from aluminium, can be bought in various shapes and sizes from fishing gear stores, but you can also make your own from used tin cans or even wood.

If lead is unavailable or too costly, sinkers can be made from lengths of steel bar, or from cement poured into tins or paper cups. These materials are not as dense as lead but can still do the job. Whatever material you use, insert some wire or cable into the sinker to make a strong attachment point.

More information on sinker types is given in the descriptions of each fishing method.

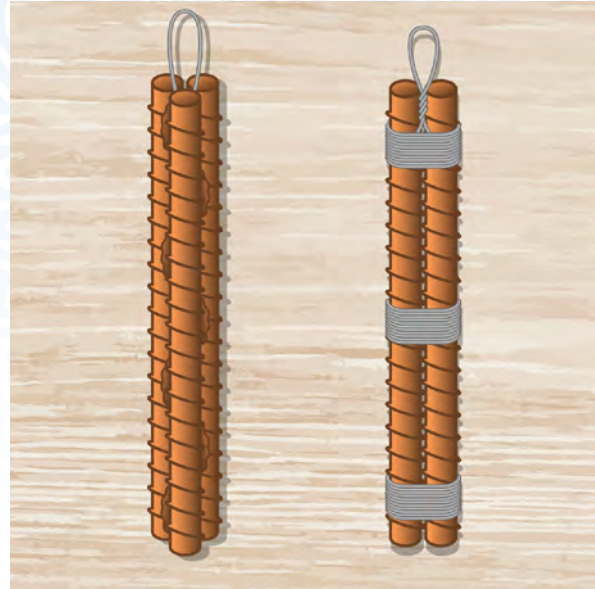

Homemade rebar sinkers.



Ball, bell, egg, rod, inline and banana sinkers.

3.6 Bait and chum

Bait

Most fishing methods in this manual use hooks and lines to catch fish. Hooks may be attached to artificial lures or they may use natural bait, which can be a whole fish (such as a scad or small mackerel), strip bait (fillet or belly flap) or cut bait (chunk or piece).

Whole fish and strip bait are often used for trolling and mid-water line fishing, while cut bait are more commonly used for deep-bottom fishing and, sometimes, longlining.

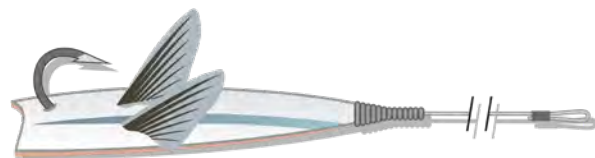

... and strip bait rigged for trolling...

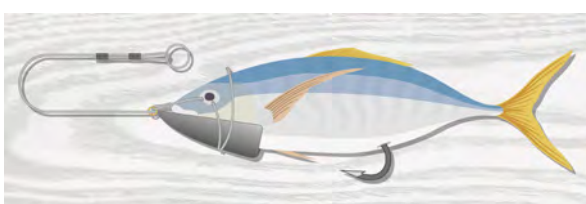

Using a whole fish...

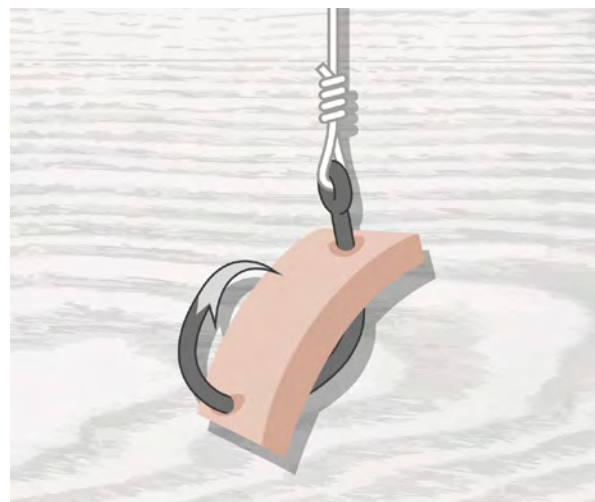

... and cut bait prepared for bottom fishing.

Salting

Oily bait such as tuna easily becomes soft and mushy, especially after it has been frozen. To prevent this, the bait can be hardened by salting it for a few hours before fishing. To harden the bait:

- cut it into chunks;
- sprinkle with plenty of salt, or mix in a bucket with at least a third as much salt as there is bait;
- do not add water;
- after 2-3 hours, the outside of the fish chunks will toughen and hold onto the hook better.



Cut bait into pieces...



...and sprinkle them with a lot of salt.

Salting can also be used to preserve bait when there is no refrigeration, or when bait is hard to come by. The more salt you use, the longer the bait will last. Chunks of fish can be salted whole, but fish larger than 1 kilogramme should be filleted or cut into pieces. To preserve bait: 1) mix the fish chunks with at least a third as much salt as there is bait, 2) stir, and 3) store the salted bait in a sealed container.



Bait mixed with salt will harden in a couple of hours.

Chum

Chum (also called burley) is ground up bait that is placed in the water to attract fish. Chum is made of finely chopped food scraps or waste such as fish, meat, vegetables, cooked rice or cassava. Many fishers have their own special chum recipes, such as chewed up coconut meat or ground boiled sweet potato mixed with the mashed flesh of scads or small mackerels. Chum can be salted for later use in the same way as bait.

Once the chum is made, it is placed in the water close to a baited hook or line of hooks. But, this can be very hard to do in deep water. Each of the sections in this manual that discuss fishing methods provide more information on how to get the chum where it needs to go.



Chum is made up of a mix of all kinds of chopped food or garden scraps.



4 Knots, crimps and splices

4.1 Know your knots

Knowing how to tie knots properly is a key part of fishing and is essential for boat operations and safety. Poorly tied knots in anchor ropes or mooring lines can result in the loss of an anchor or damage to your boat, and may cause injury to you and your crew.

Basic knot types

Every fisher should be familiar with several kinds of knots.

- **Rope knots** are used for mooring the boat, attaching the anchor, lashing down gear and equipment, and other boat handling purposes. Rope knots should be quick and easy to tie but they should also be easy to undo. There is nothing worse than a jammed or tangled knot that cannot be undone when you need to let the rope go.
- **Line knots** are used to join lengths of line together.
- **Hook and swivel knots** are used to attach hooks, rings, swivels and lures to a line.
- **Loop and dropper knots** are used to form loops in the body of the line or at the end. The loops are often used as an attachment point for other lines.

There are many kinds of knots in each of the above categories, and this manual shows a few of the best ones. There are many books and internet resources that provide more information.²

Overhand knots

The most basic and common knot is the overhand knot. Single or double overhand knots can be used to quickly join two lines together, to make simple end loops, and as a stopper knot on a rope.

Lines can be joined together with a fisherman's knot, which uses two overhand knots, or by tying a reef knot.

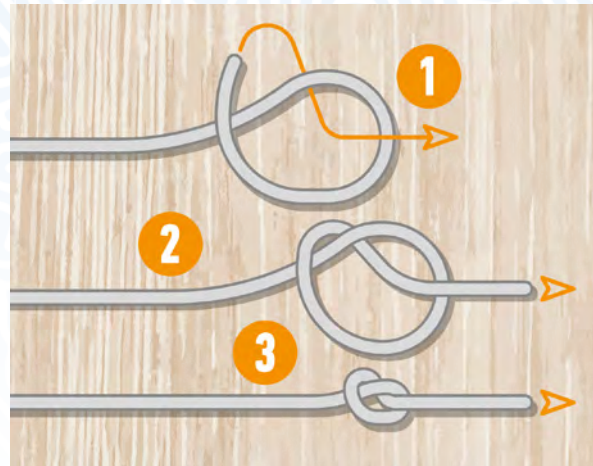

Single overhand knot.

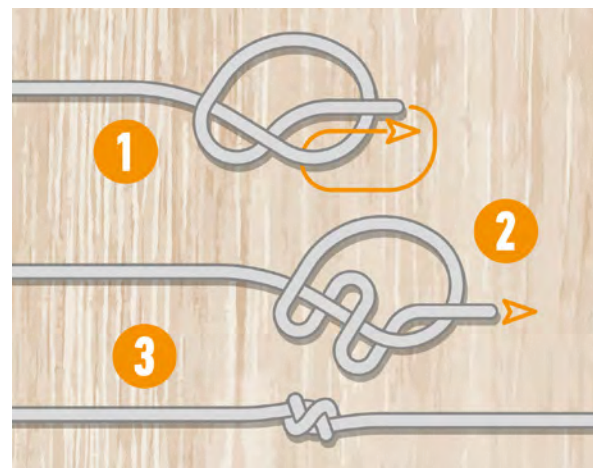

Double overhand knot.

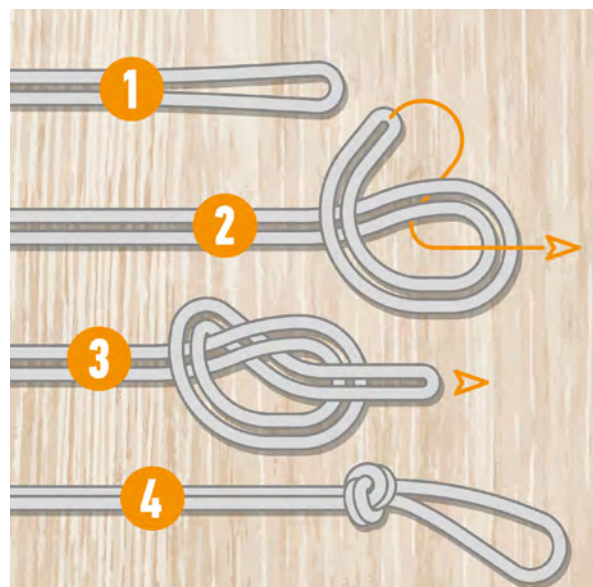

End-loop overhand knot.

² See Geoff Wilson's books *Complete book of fishing knots and rigs* and *Fishing baits and rigs*. Also check out the websites Animated Knots (<https://www.animatedknots.com/>) or NetKnots.com (<https://www.netknots.com/>).



Fisherman's knot

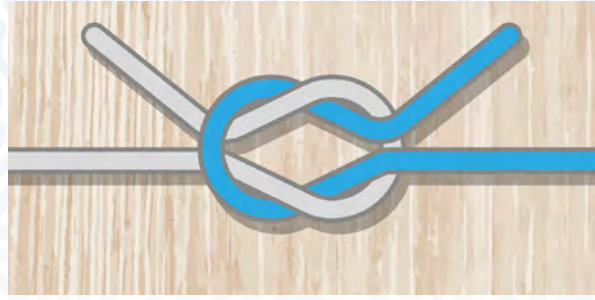

Reef knot

Crimps

Sometimes it is better to use crimps instead of knots, especially with heavy monofilament line where it is hard to make the knots tight. And, when working with cable where knots cannot be used, brass or copper crimps – single lock or dual lock – are used instead. Aluminium crimps should not be used on stainless-steel cable because they will cause galvanic corrosion of the cable (see [section 9.3](#)).



Crimps



Crimping tool

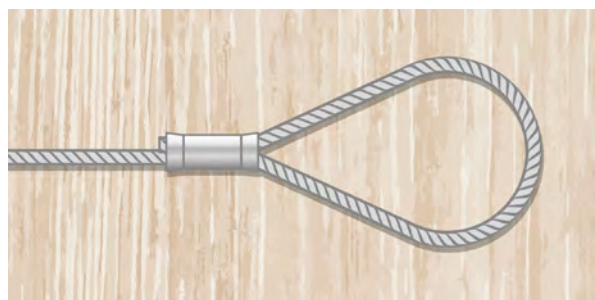

Finished crimped eye

Crimps can be used with monofilament, wire or cable to do many of the things that knots can do, including

joining lines, attaching hooks and swivels, and creating end loops where other lines can be attached.

Splices

Splices are used to join lengths of rope, cable or other multi-strand lines to one another. A splice is made by partially untwisting one end of two separate ropes, cables or wires, and then braiding them together to make one length. Special tools are needed to both separate and re-braid the strands of rope or wire.

Splices are very strong and form a smoother joint than a knot or a crimp, and work well if the line has to run through a pulley or sheave where a knot might jam.

Many kinds of splices can be used to: make a neat finish on the end of a rope or cable with a back splice; join two lengths of rope or cable together with a short or cut splice; or create loops and attachment points with an eye splice.

Splices are also used when fitting "eyes" or "thimbles" into ropes to protect them from chafing, such as where an anchor rope is attached to a length of chain.

Splicing is not covered in detail in this manual, but there are many books and online resources available for those who want to know more.



Back splice



Short splice



Cut splice



Eye splice

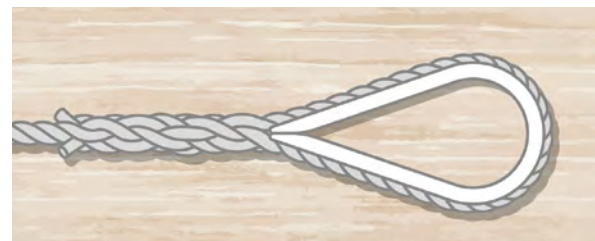

Eye splice protected by a thimble.

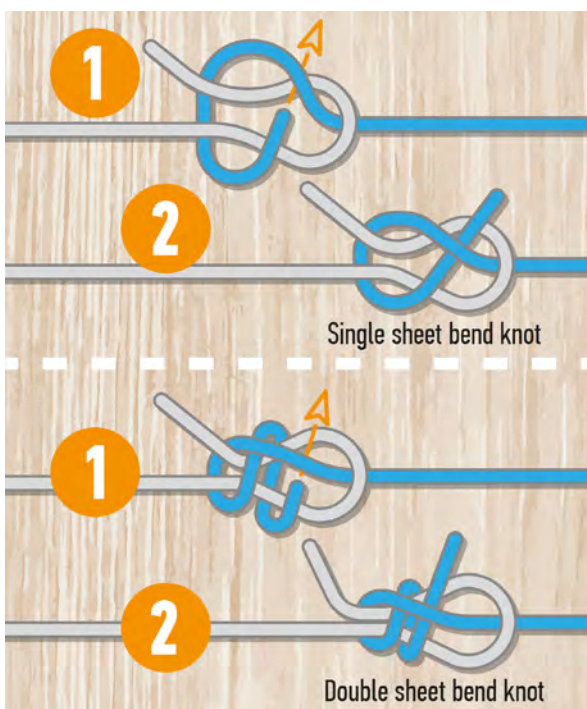

Single sheet bend knot

Double sheet bend knot

4.2 Rope knots

Sheet bend (single and double)

Use: For quickly joining ropes of equal or unequal diameter.

An advantage of the sheet bend knot is that it can quickly be untied when needed.

◀ Single and double sheet bend knots.

Round turn and two half hitches

Use: securing the end of a rope to a fixed object, such as a bollard or rail.

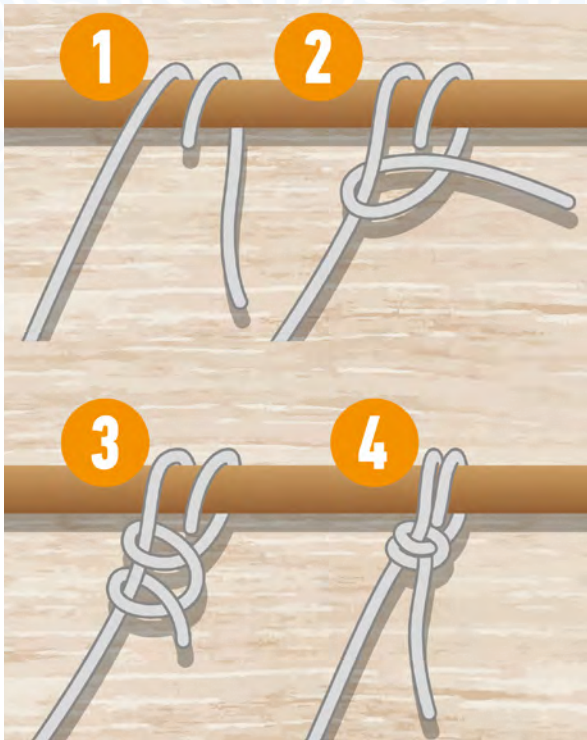

Round turn and two half hitches.

Clove hitch

Use: quickly securing a rope to a post, rail or other object.

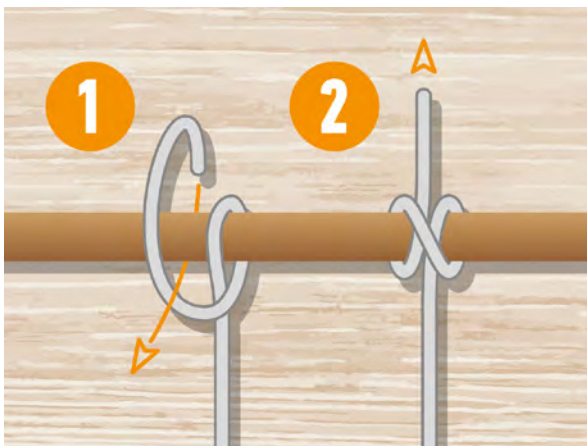

Clove hitch

Warning! The clove hitch can be a dangerous knot. Under a heavy load it can pull so tight that it becomes impossible to undo. Because of this, we do not recommend using clove hitches for temporary attachments. Only use it in situations where you want the fastening to be permanent.

4.3 Line knots

Double uni knot

Use: joining lines of roughly similar diameter or strength, such as connecting braided line to a fluorocarbon or monofilament leader.

- When tying mono to braided line, make about 5 turns with the mono and about 8 with the braided line. Remember to trim tag ends close to the knot.

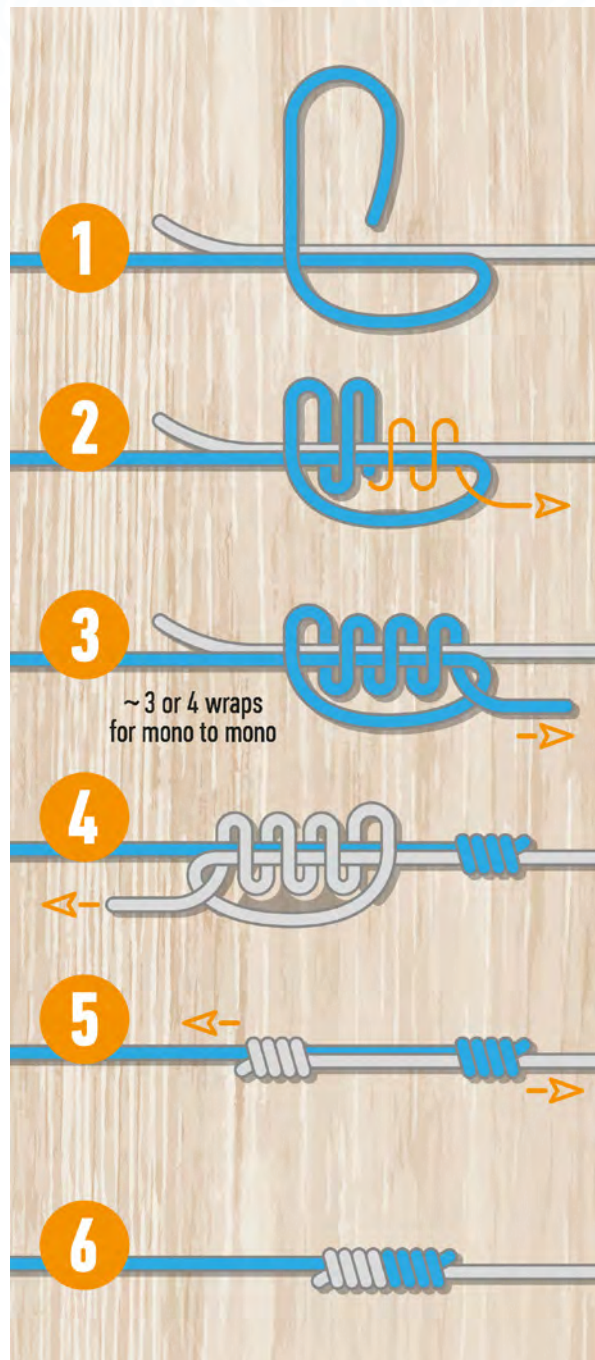

Double uni knot

Blood knot

Use: joining two lines of similar strength and diameter, particularly monofilament.

- When using monofilament, moisten the lines with saliva or water to help tighten the knot.

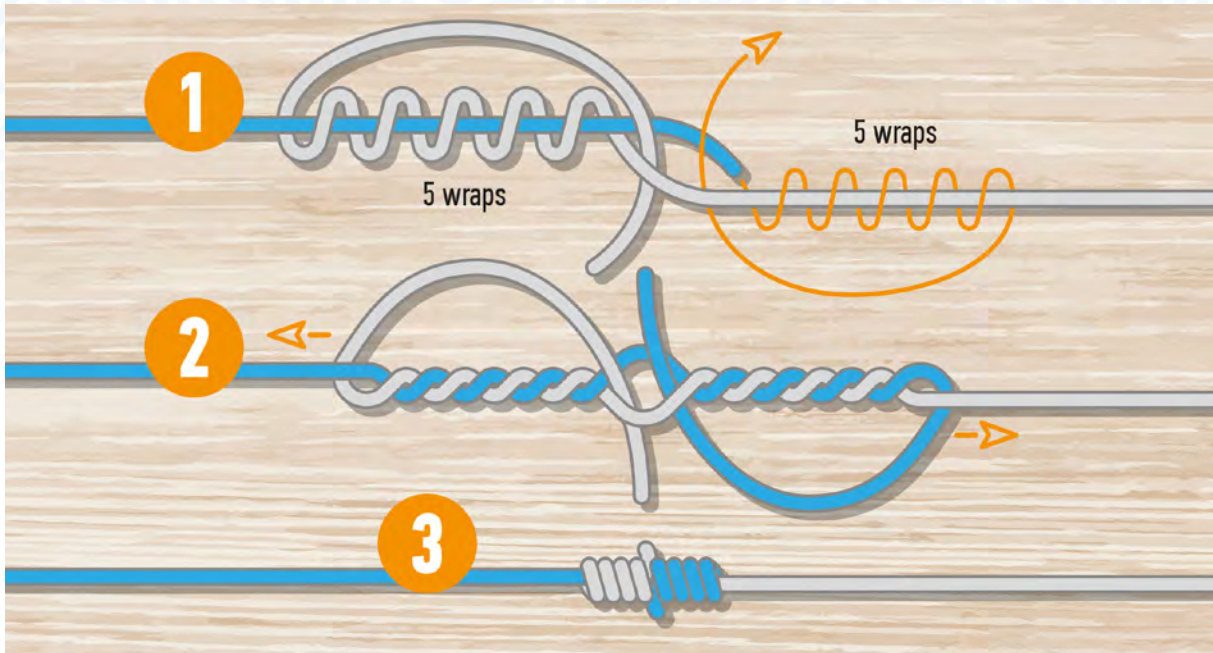

Blood knot

Albright knot

Use: joining lines of unequal diameters or different materials, such as monofilament to braid.

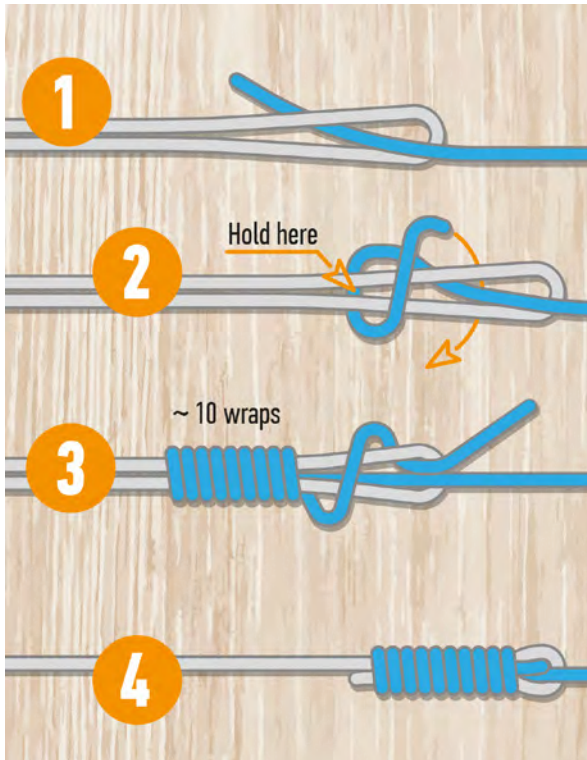

Albright knot

4.4 Knots for hooks and swivels

Uni knot

Use: tying a swivel or hook to a fishing line.

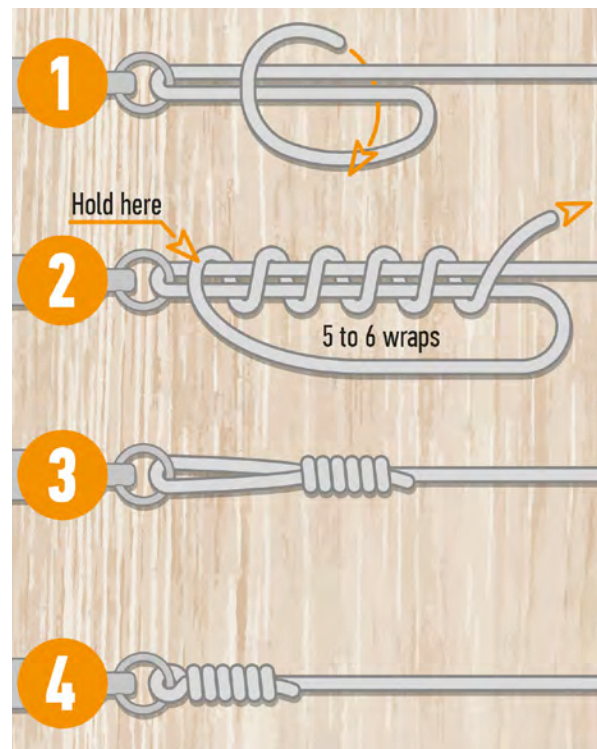

Uni knot

Clinch knot

Use: attaching a hook to a fishing line.

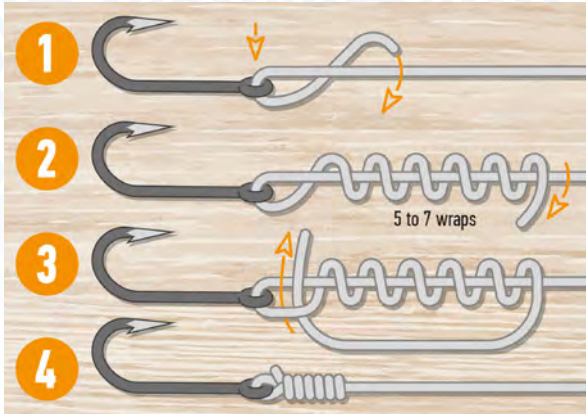

Clinch knot

Fisherman's snell knot

Use: attaching a hook to a fishing line.

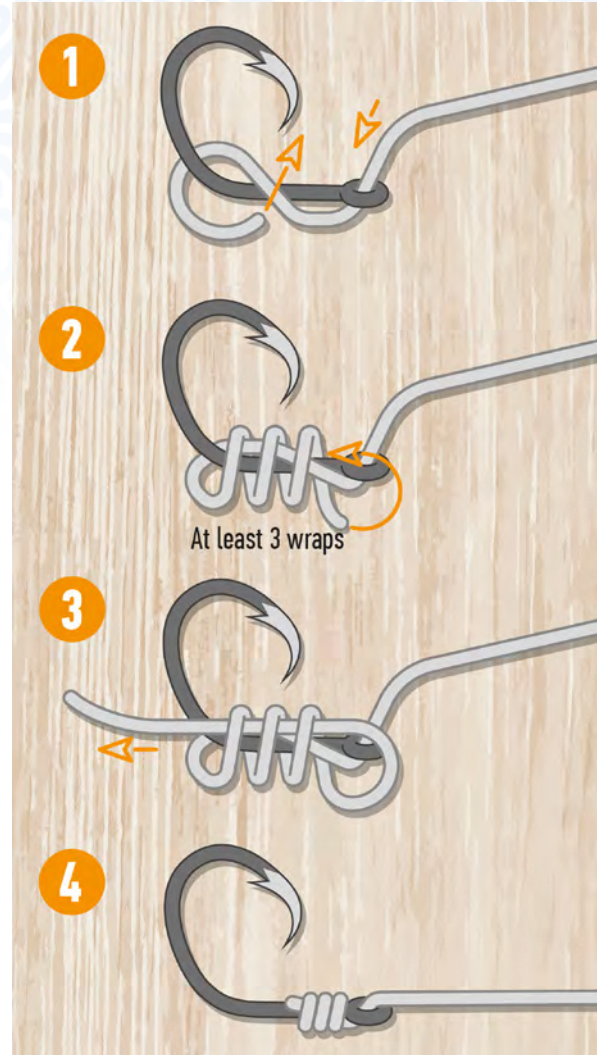

Fisherman's snell knot.

Palomar knot

Use: attaching a line to a hook or lure.

- The knot should lie above the hook eye, not on the shank.

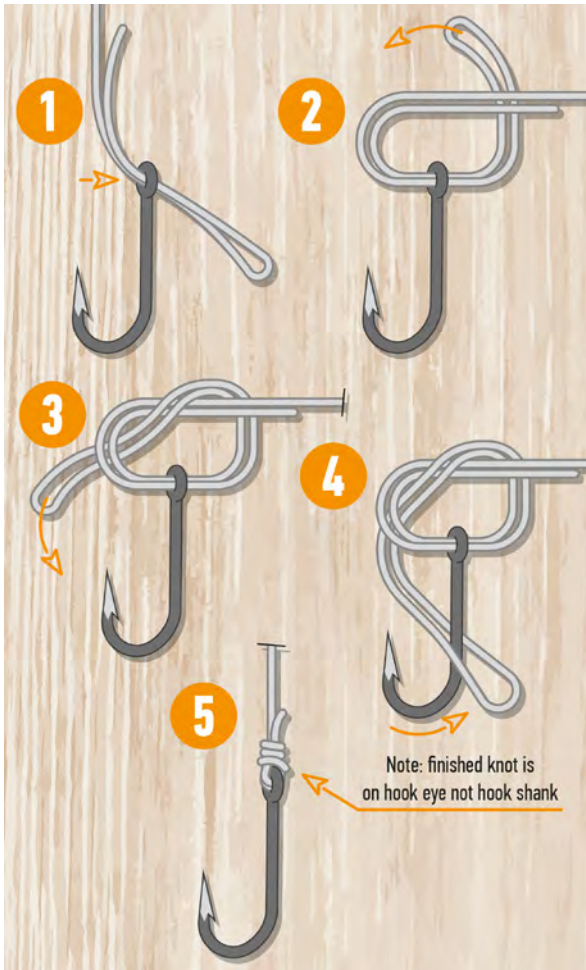

Palomar knot

4.5 Loop and dropper knots

End loops are an easy way to make temporary line connections. These are needed for trolling lures or hook rigs, so that they can easily be attached, disconnected and changed as needed.

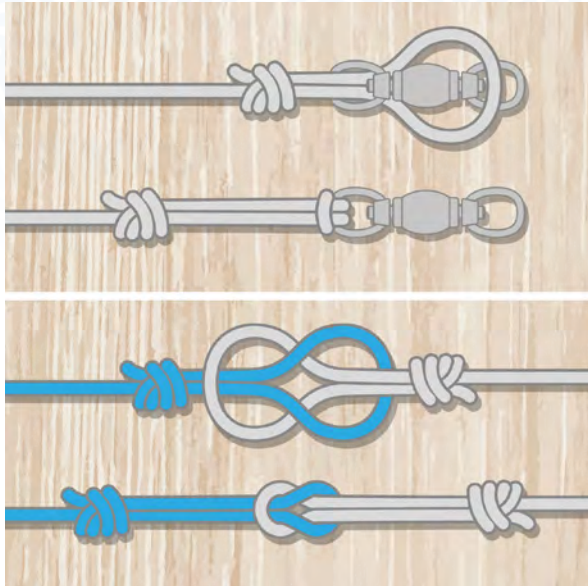

End loops make it easy to connect and disconnect line sections.

End loops are formed by knots, splices or crimps, using different techniques, depending on the type of line material being used.



Knotted, crimped and spliced end loops.

The following sections show some additional ways to make end loops in rope, cable and wire.

Bowline

Use: making a fixed loop at the end of a rope or line that will not slip after being tightened. This is the favourite knot of many mariners because it can be untied easily even after being subjected to very high tension

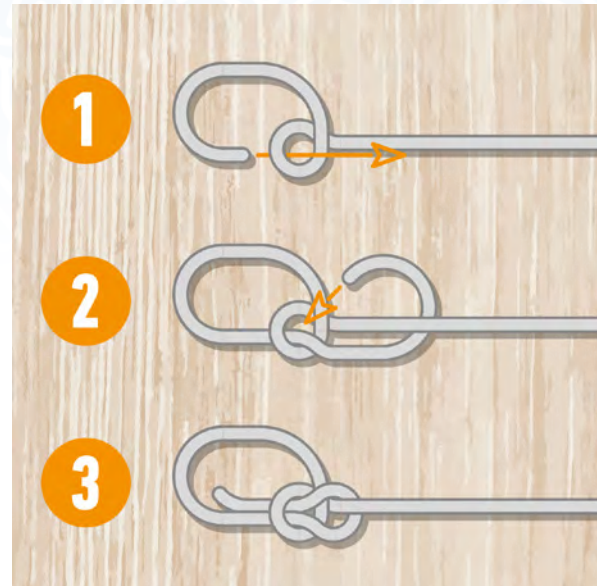

Bowline knot

Crimped eye

Use: mainly for multi-strand wire cable, but also for heavy-duty monofilament line, where a standard knot would be difficult to tighten up.

- Ensure there is enough cable left to just fit neatly in the crimp, with no end bits of wire exposed.
- Firmly close the crimp with a crimping tool.

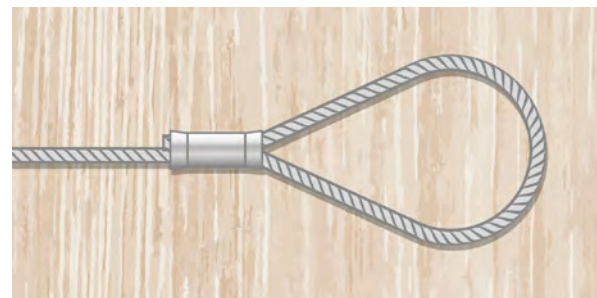

Crimped eye

Flemish eye

Use: for multi-strand wire cable or monofilament, it provides chafe protection in the loop.

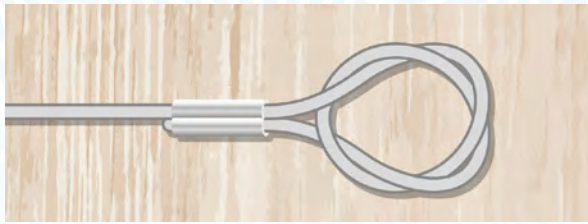

Flemish eye

Haywire twist and barrel roll

Use: making end loops in single-strand wire.

- Be careful to snap off the remaining working end of the wire by flexing it several times until it breaks.
- Do not to cut the working end with pliers because this will leave a sharp point that can nick or cut you.

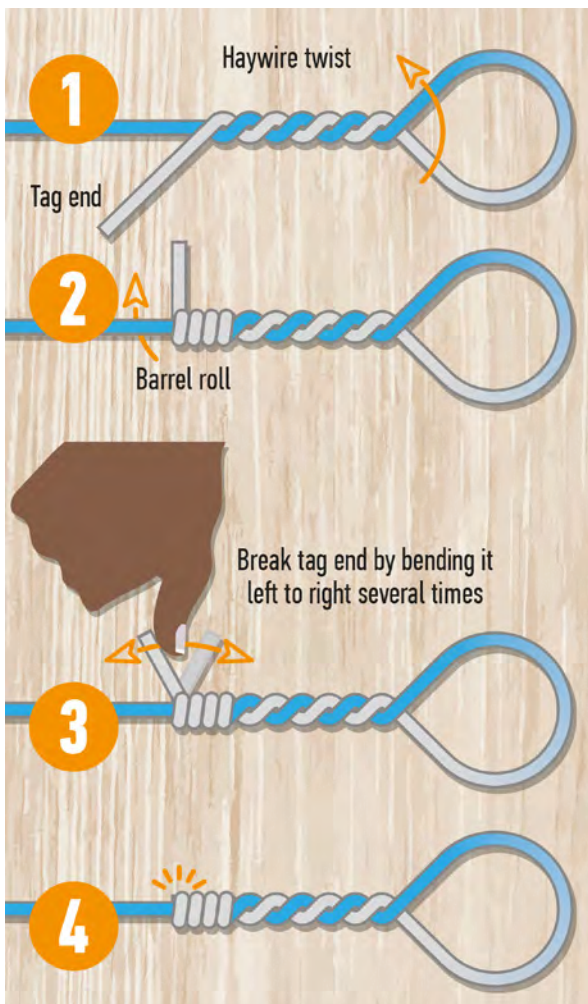

Haywire twist and barrel roll.

Harness knot

Use: forming a loop within a line or rope.

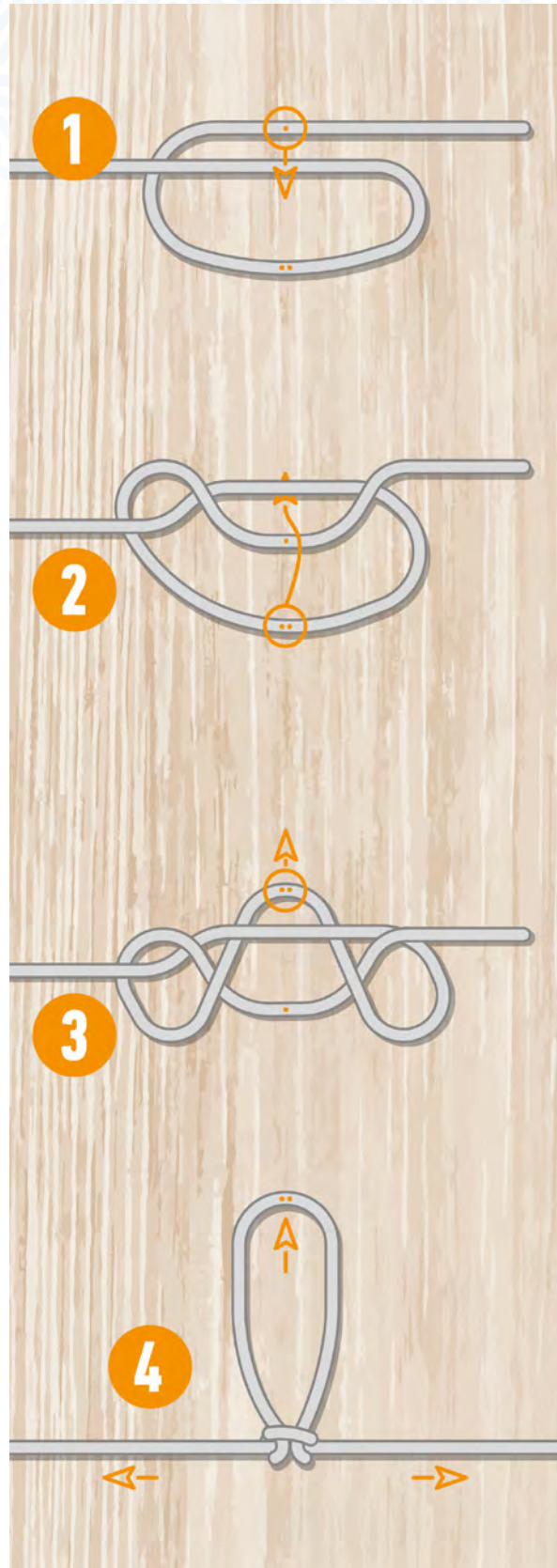

Harness knot

Dropper loop

Use: a modified version of the harness knot, used to make an attachment point for hooks or branchlines.

This knot is often used in deep-bottom fishing rigs. If the knot is made in braided cable (such as the Turimoto wire), take three twists instead of five to make it easier to pull tight, and use pliers to work the wire.

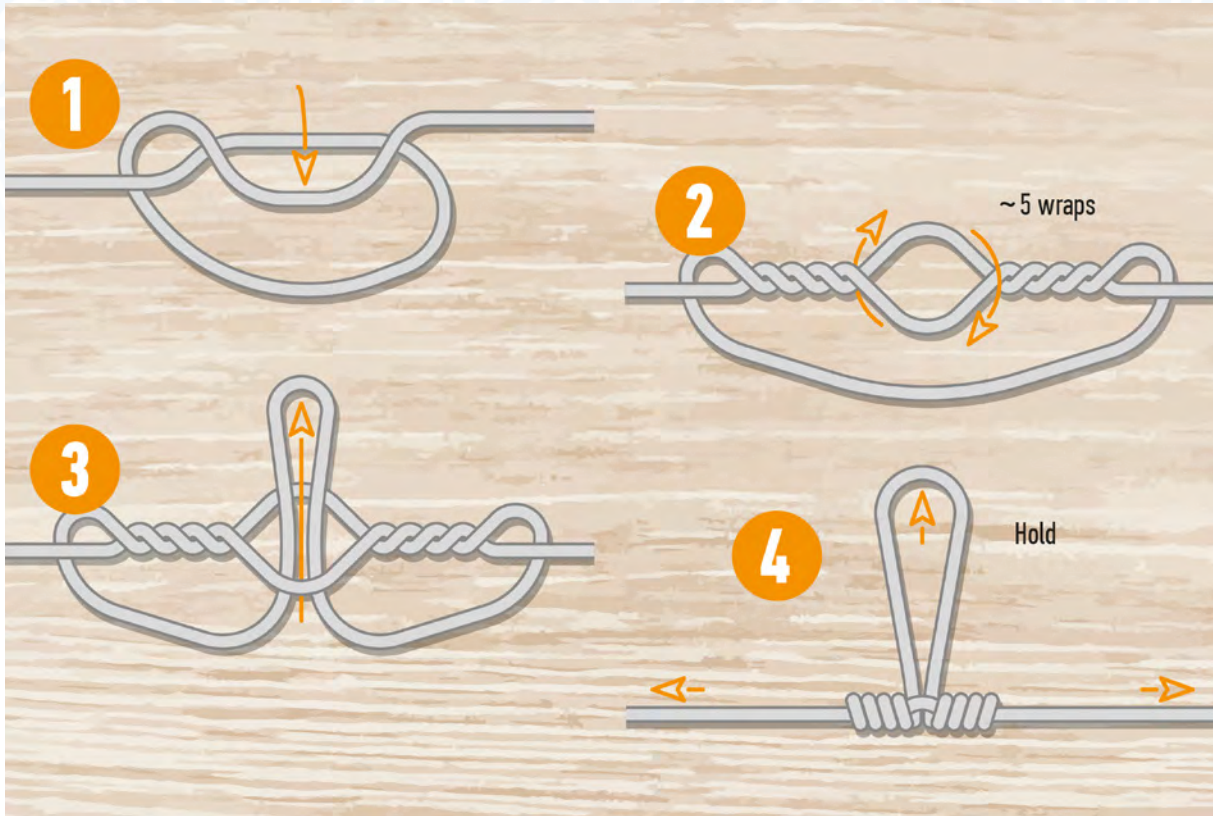

Dropper loop



5 Trolling basics

Trolling is a fishing method where one or more fishing lines – with lures or baitfish – are towed behind a vessel. The mainline is attached to a monofilament line, wire or cable leader with one or more artificial lures or fresh bait. There are many types of lures and bait for trolling, as shown below. Lures or bait can be towed through the water either at the surface or subsurface, and many types of fish are targeted by trolling (see [section 1.3](#)).

Trolling is the most commonly used surface fishing method in the majority of Pacific Islands, and its popularity has grown even more since the introduction of motorised boats. Trolling can be done from a paddling or sailing canoe, or from a boat with either an inboard or outboard motor. Trolling is done by recreational fishers, subsistence fishers, part-time and full-time commercial fishers, and charter boat (game) fishers.

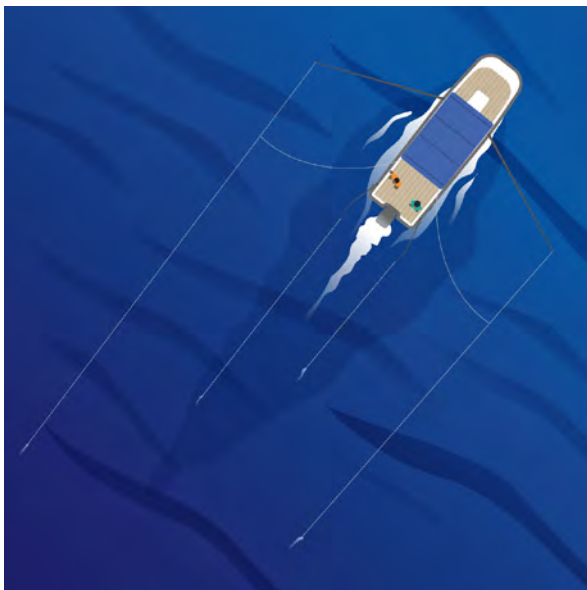

Trolling with two lines from the stern and two from booms set on each side of the boat.

A variety of hooks can be used in trolling (see [Chapter 3](#)) but the non-offset single “J”, double or treble hooks are the best.

When trolling, set out longer troll lines before setting shorter ones. When hauling the lines back in, the shortest lines are pulled in first and longer ones last.

If you are trolling for tuna, go early in the morning or late in the afternoon; you will have the most success during these times.

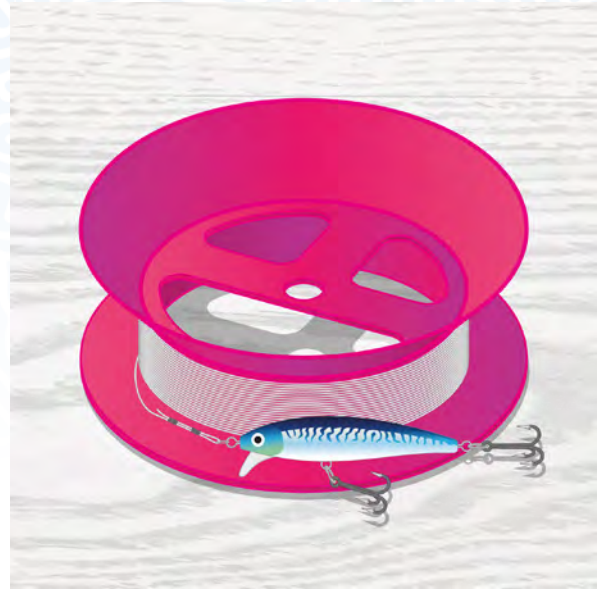

Trolling line stored on a handcaster.

A handcaster is a light, portable hand reel. It usually has a flat rim on one side and an angled rim on the other, onto which the fishing line is wound. When casting, the reel is held in one hand and the baited hook is cast with the other, keeping in mind that the angled rim should always face towards the cast direction.

[Section 3.4](#) provides some general information about the way nearshore fishing lines are rigged, and the role that the mainline plays.

A trolling mainline can be used in several ways.

- The most basic way is a fixed line that is attached to a strong point on the boat, or to a trolling boom. A fixed line should be wound onto a handcaster or other spool when it is not in use.
- Trolling can also be done using wooden hand reels or commercial fishing reels.
- Many fishers use sport-fishing rods and reels.

The mainline, which makes up most of the length of the trolling line, should be strong but light, and durable enough that it will not need replacing too often.

For fixed mainlines, you can use monofilament nylon or braided lines of about 100–300 kg breaking strain. The length of the mainline depends on the type of trolling you plan to do, but 30–50 m is common.

For mainlines on reels, you should use a braided line with a minimum breaking strain of about 25 kg. The line can be as long as you can fit onto your reel.

5.1 The leader

The leader (sometimes called the trace) is a lighter-weight section of line that connects the lure to the mainline. Several reasons for using a leader are:

- because the leader is lighter than the mainline, it is less visible to fish, and this increases the chances of fish being caught;

- the leader material can be adapted to fishing conditions - for example, wire leaders can be used when sharp-toothed fish like wahoo are being targeted; and
- lures and their leaders can be easily swapped after a fish is caught, or when the fisher wants to try a different lure or bait.

The breaking strain of the leader is typically between 45 kg and 140 kg, depending on the size of the target species. Keep in mind that the breaking strain must be less than that of the connecting lines and mainline.



If a fish can see the line, it is less likely to strike.

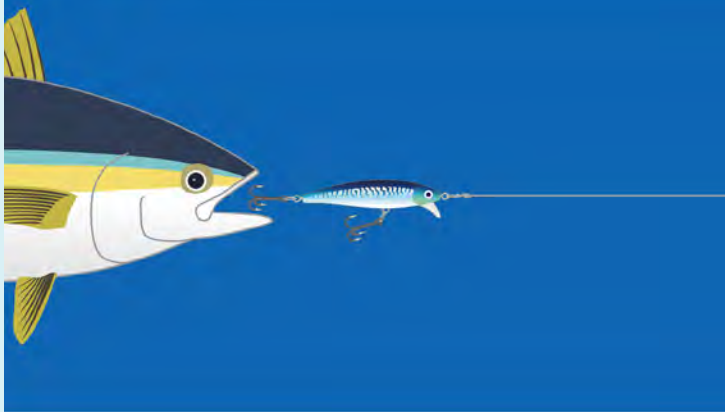

For soft-mouthed fish (like tuna, mahi mahi or billfish), use monofilament line.

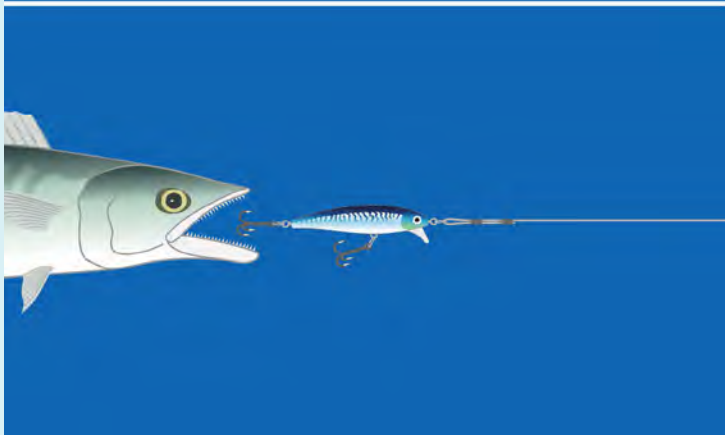

For sharp-toothed fish (like wahoo and barracuda), use wire or cable.

5.2 Matching the gear

As with all line fishing methods, it is very important that you use the right size and weight of lines, hooks, lures and other gear in combination with one another.

- The mainline should be stronger than the leader so that if a big fish strikes, only the leader will break, and not the mainline.
- A small bait fish or lure that is attached to a leader that is too thick and stiff will not move through the water properly and will likely not attract fish.
- An oversized piece of bait or a lure attached to a leader that is too light or weak could cause the leader to break when a fish strikes, and the fish could be lost.

Mismatched gear could become broken or may not perform properly, both of which can cost you time and money.

5.3 Rigging trolling lines

Shock absorbers

A fixed trolling line consists of a mainline that is attached to the boat, usually by tying or clipping it onto a short length of backing made from strong cord. The other end of the mainline trails in the water behind the vessel, and is fitted with a strong swivel, clip or snap and leader.

Fixed lines should always be fitted with a shock absorber, sometimes called a snubber, to absorb the impact of a fish strike, and prevent the line from breaking. The shock absorber should be rigged into the mainline backing, close to the point where the line is attached to the boat. A safety rope must be added, as shown below, in case the shock absorber breaks when a fish strikes.



A shock absorber mounted on a fixed trolling line.



Shock absorbers must be placed close to the boat or the booms.



Commercial trolling line shock absorbers (top three) and some materials you can use for making your own.

Shock absorbers can be bought commercially or made from commonly available materials, such as old inner tubes, bungee cord or speargun rubber.

Most fishers have their own way of rigging shock absorbers into fixed trolling lines, depending on the way the boat is laid out, the materials available locally, and the fishing method. The next section shows one way of doing this, using a length of speargun rubber.

Making a shock absorber into a fixed line

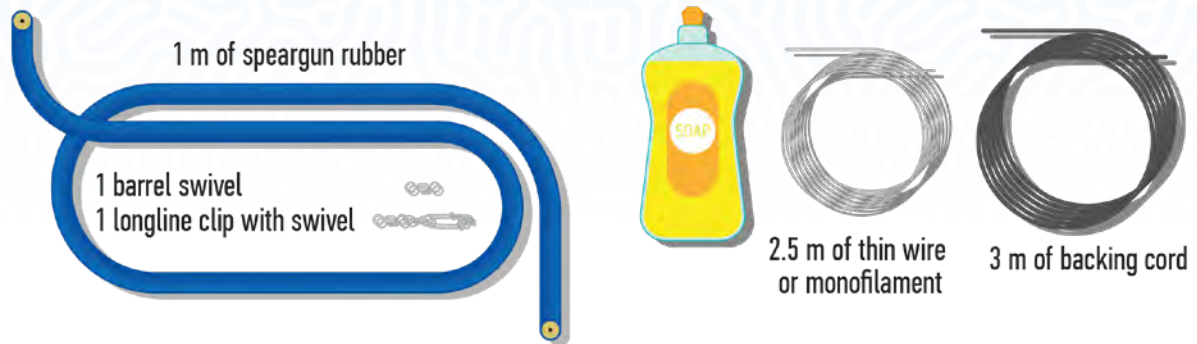

Materials needed to make a shock absorber with a length of speargun rubber.

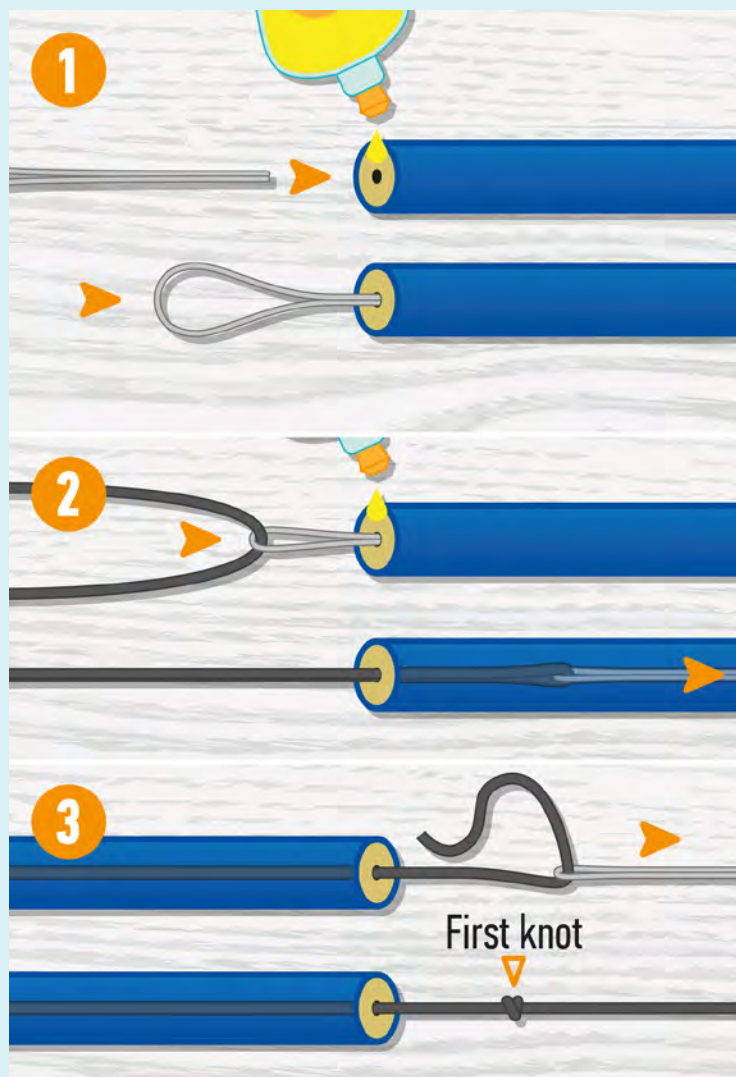

1. Bend the wire or monofilament in half and pass it through the speargun rubber. Use liquid soap to facilitate the passage.

2. Use the wire or monofilament loop to pull the backing cord through the rubber. Use liquid soap again.

3. Tie a first knot on the backing cord, 0.5 m from its end.

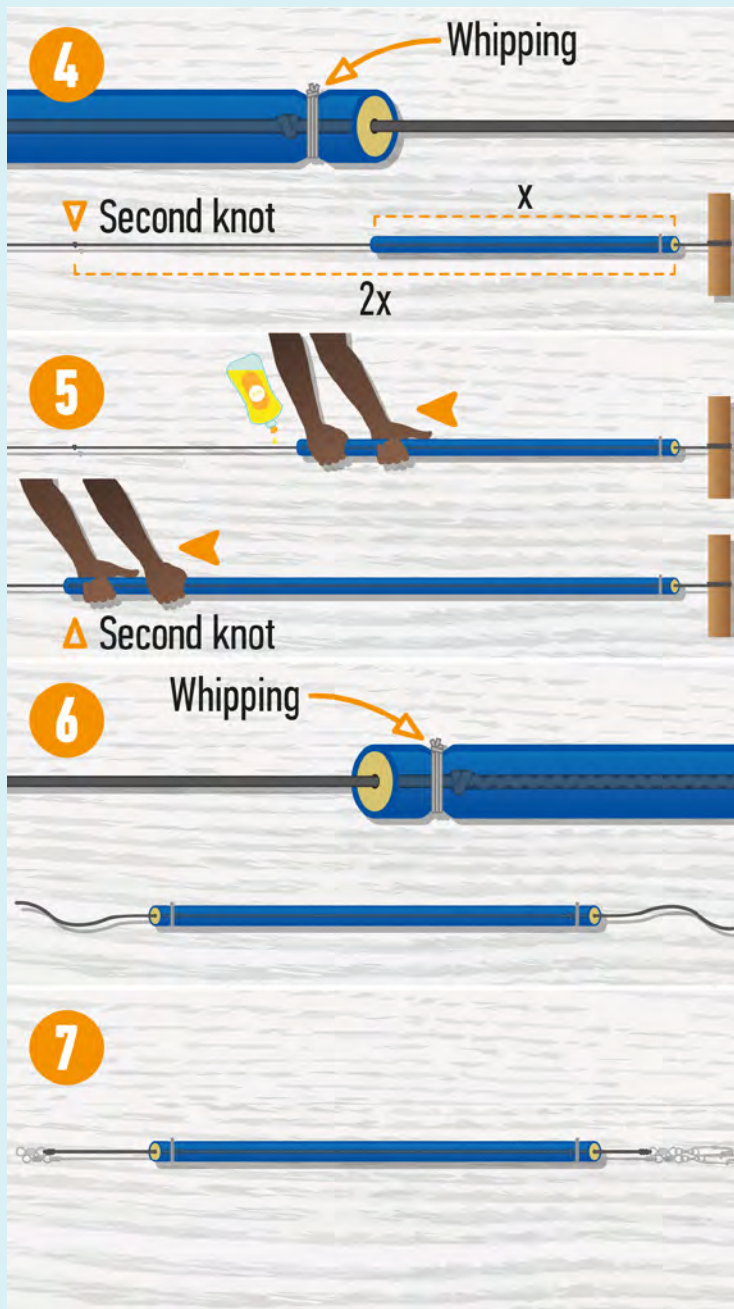

4. Pull back the knot in the rubber, and whip the rubber tightly close to the knot, using a clove hitch (see section 4.2), to stop it from slipping out. Tie a second knot 2 m away from the first one.

5. Attach the backing cord to a strong post and pull the rubber until it covers this second knot. Use liquid soap again.

6. When the rubber retracts, the backing cord is bunched up inside and acts as a safety rope if the rubber breaks. Whip the rubber tightly close to the second knot, using a clove hitch, to stop the knot from slipping out.

7. Attach the barrel swivel at one end of the backing cord and the longline clip at the other end so you can attach the shock absorber to a secure fixture on the boat.

Using hand reels

For several reasons, using reels for trolling is a lot better than using fixed lines. Lines can be set and hauled in quickly so that landing fish or changing lures is fast and easy. In addition, reels can be rigged with a drag mechanism to absorb the impact of a fish strike, and control the speed of the line as it runs out. This prevents the line from snapping because of a fish strike, while also tiring the fish out.

When rigging a trolling mainline on a hand reel, first load a length of backing material (see section 3.4) so that the mainline will not chafe against the reel. Then, tie a knot or clip it to the mainline and load the desired length. Finally, tie or crimp on a snap or corkscrew swivel where the leader will be attached.

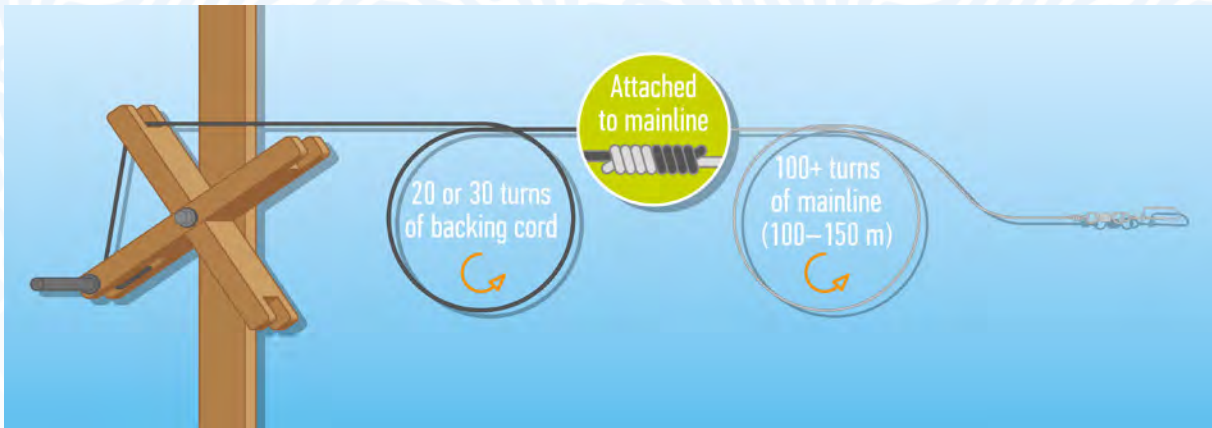

Loading a fishing line on a hand reel.

On a wooden hand reel, a brake can be easily made using a length of recycled inner tube or other rubber material. The rubber will stop the reel from turning, but when a fish strikes it will allow a few turns, thereby preventing the line from breaking while at the same time providing resistance to tire out the fish.

- make an end loop (using crimps, loops, knots or twists, depending on the material being used) so that the leader can be attached to the mainline swivel;
- then connect the lure or bait to the other end, again using a crimp, loop, knot or twist, and hook(s) depending on the leader material.

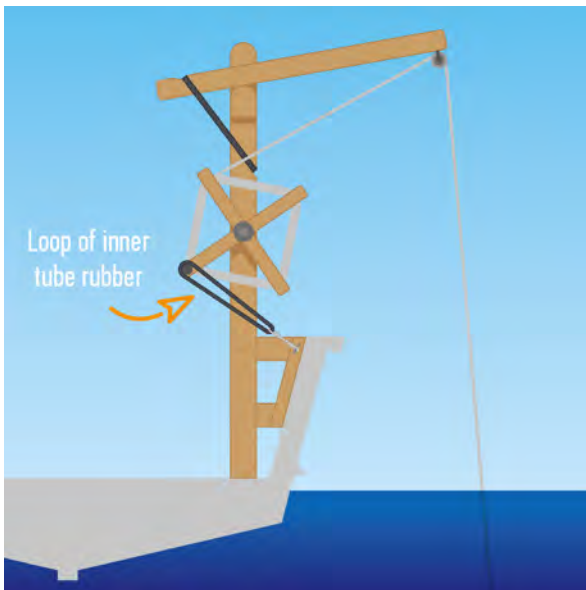

Using a loop of inner tube rubber as a hand reel line brake and shock absorber.

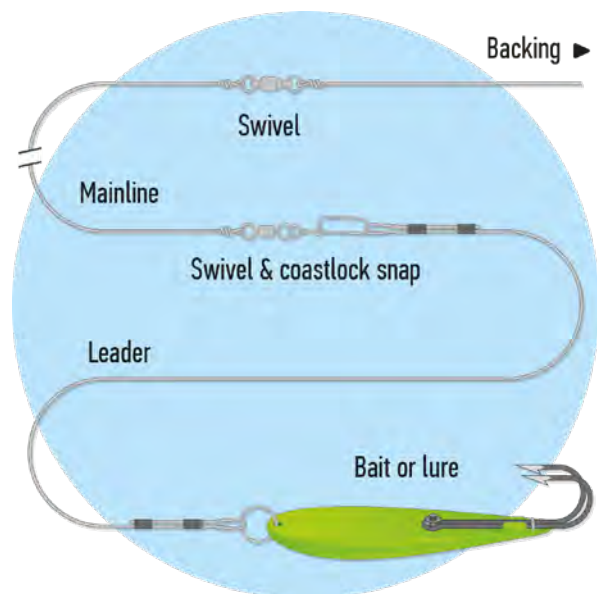

A typical trolling line.

Rigging leaders

A leader for trolling consists of a length of cable, wire or monofilament line, with a loop or clip on one end to attach it to the mainline. The other end has the lure or bait attached to it. To make the leader:

- cut the desired length of cable, wire or monofilament, typically 1–2 m;

Using the gear

- Join the leader line with the lure or bait to the trolling mainline, by connecting the leader eye to the mainline snap or swivel.
- Ensure that the hooks on the lures and bait are not tangled, before placing them in the water.
- Let out the mainline about 30–50 m.

- Troll at the right speed – slower for bait and hard lures, and faster for jigs, octopus and other streamlined lures.

5.4 Trolling with lures

Most trolling uses artificial lures, which offer lots of convenience. Lures can be used many times, are easily stored away when not in use, and with proper maintenance lures can last for months or even years.

Lure types

The range of commercially available lures is enormous, and many lures seem designed to attract the fisher, rather than the fish! Commercial lures fall into two types:

- **Hard lures** that are made entirely of reflective or brightly painted metal, hard plastic or wood; and
- **Soft lures** that are made from rubber, feathers or other flexible material, attached to a solid head.

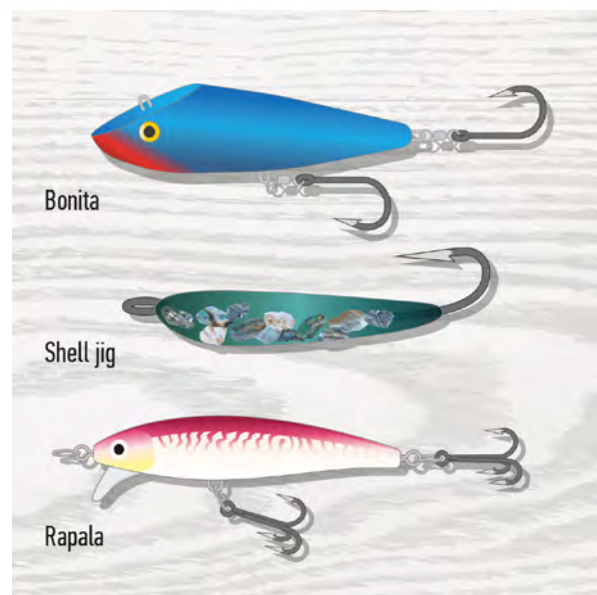
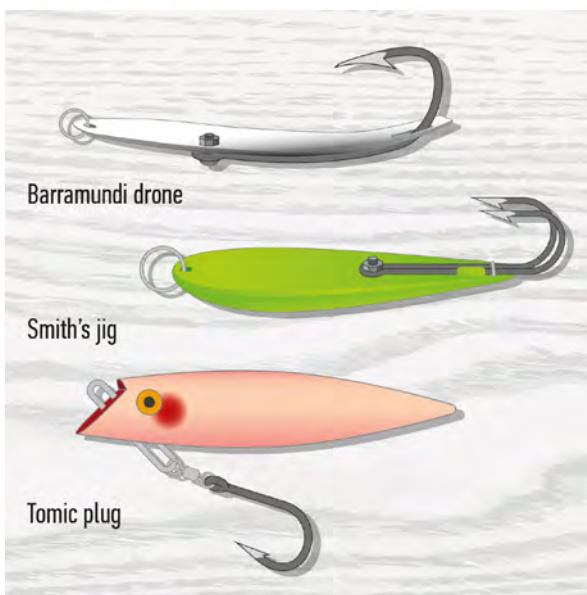

Hard lures



Soft lures

The most widespread lure in the Pacific Islands region is the octopus lure, which comes in many sizes and colours. The skirts are tied to the heads using twine or dental floss, and can easily be replaced when damaged.

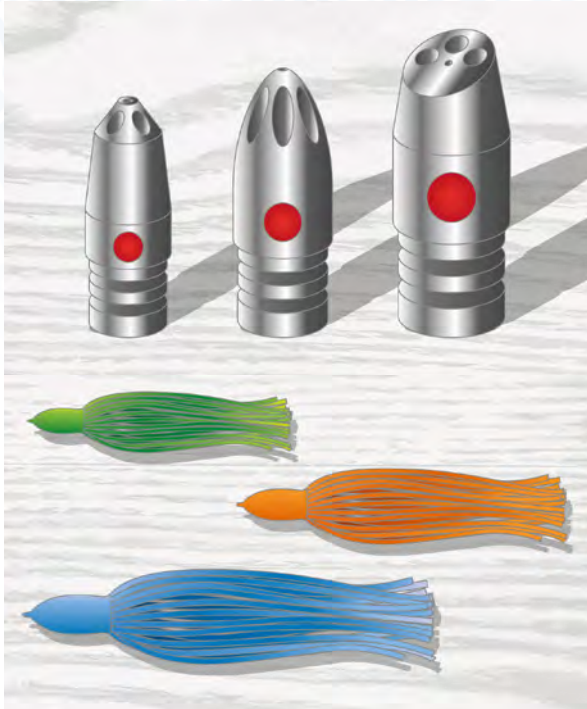

Just a few of the octopus head styles, skirt lengths and colours available.

You can make your own lures using lead sinkers, sections of metal tubing, ballpoint pen bodies, plastic screwdriver handles, chicken feathers, strips of cloth and other household materials.



Home-made lures are limited only by the imagination!

Single lures

The simplest type of trolling gear uses a single lure on each trolling line, although some boats may be able to troll with two, three or more lines.

Single lures are rigged on a simple leader. The type of lure and leader material will depend on what you are trying to catch, but light monofilament leaders and small octopus lures are good for schools of skipjack, and heavier leaders and bigger lures work better to catch large tunas, while hard lures on wire leaders are best for wahoo.

When you troll with larger lures, you can increase your chances of catching fish by rigging the leader with two hooks. For a two-hook rig:

- cut a short length (1.5–2.0 m) of leader line or wire;
- crimp a hook on one end; and
- crimp the other hook to the same leader eye that the first hook is attached to.

For skirted lures, the first hook should be hidden in the skirt, while the second hook should hang close to the end or just outside of it.



The first hook on a two-hook rig should hang inside the lure's skirt, the second one close to the end of the skirt or just outside of it.

If you are using a monofilament leader, use knots or aluminium crimps to form the eyes and attach the hooks.

Multiple lures

Some fishers like to troll with two or more lures on the same mainline – more fish, more fun!

The two main variations are daisy chains and tandem rigs:

- To make a daisy chain, attach four or five lures on short leaders all together. The first leader is attached to the mainline, the next leader is joined to the eye of the leader in front of it, the third leader is joined to the eye of the leader in front of it, and so on. The last lure in the line is usually bigger than the other ones and is the only one with a hook. The idea is to mimic a medium-size fish chasing a school of smaller fish.

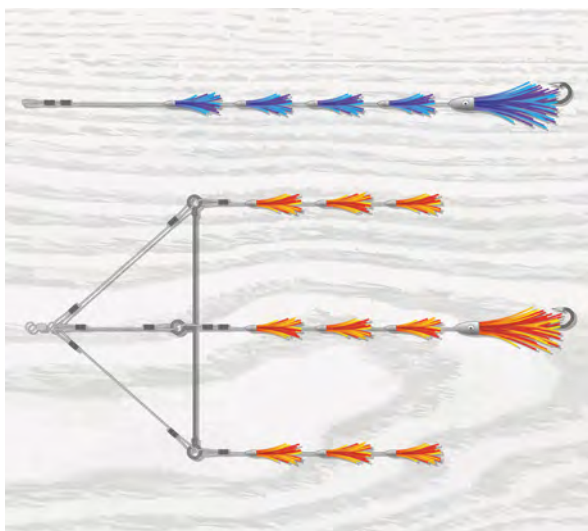

Two types of daisy chains.



A tandem trolling rig.

- To make a tandem trolling rig, attach the leaders of two lures to the snap at the end of the mainline, making sure that one leader is about twice as long as the other. Only use soft and non-spinning lures when you make a tandem trolling rig.

Trolling multiple lures on tandem trolling rig works best with small fish. Two or more large fish on the same mainline line are just too many to handle at once, so use only small lures (3–15 cm long).

Multiple lure trolling is typically done on an actively feeding school of skipjack tuna or other small pelagic fish where the feeding frenzy may only last for a few minutes and time is of the essence. Pulling in two tunas at a time on the same line is not only lots of fun, but can fill the ice box quickly and reduce fishing time and cost.

Lure trolling tips

Here are some tips for when you are ready to begin trolling:

- If you troll slowly (4–8 kt), use rigged baits, plugs, pushers, and hard lures (rapalas or Smith's jigs).
- If you troll faster (10 kt or more), such as while chasing tuna schools or traveling to and from distant fishing grounds, use bullets and jets.
- Use light line (< 35 kg breaking strain), and small hooks and lures for small fish.
- Use > 35 kg and up to 90 kg (breaking strain) line if you are fishing for wahoo, mahi mahi or larger tuna.
- When you troll around a school of fish, try not to cross the centre of the school because this will spook the fish and cause them to swim deeper than your trolling gear.
- If you come across floating objects, troll around them. Tunas and other schooling fish often hang around dead trees and all kind of floating debris, including coconuts.

5.5 Trolling with natural bait

Besides using artificial lures, you can also use fresh or frozen bait. Many fishers consider bait to be more effective at catching fish, at least for large fish such as wahoo, Spanish mackerel or billfish. But, trolling with bait involves a lot more work than using lures. The bait first needs to be caught or bought, and then carefully rigged onto trolling hooks. Trolling using natural bait can generally only be done at lower speeds, otherwise the bait will spin or break. When a fish strikes, the bait is usually ruined, even if the fish does not become hooked.



Mackerel



Flyingfish



Garfish



Bigeye scad

Some good natural bait.

A whole fish or a strip of fish is rigged onto one or more hooks. Good types of natural bait are small silvery fish (10–40 cm long) such as mackerel, garfish, flyingfish and big-eye scad.

Strip bait – such as barracuda fillets or tuna belly flaps – can also be used. Bait should be as fresh as possible, but after rigging they can be frozen for later use.

The kinds of fish caught when using natural bait include tuna, billfish, mahi mahi, wahoo and barracuda. Natural bait is also good for catching trevallies and Spanish mackerel in waters closer to shore.

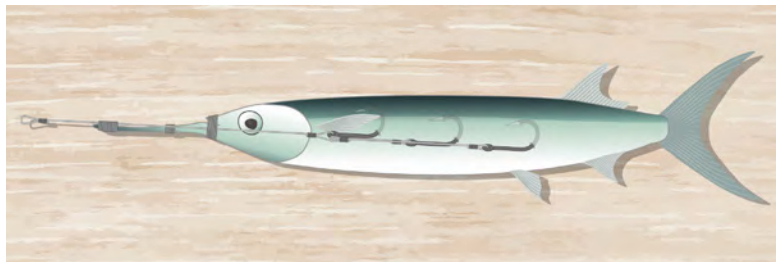

A garfish rigged for trolling with multiple hooks. Hooks can also be ganged (see illustration in [section 3.1](#)).

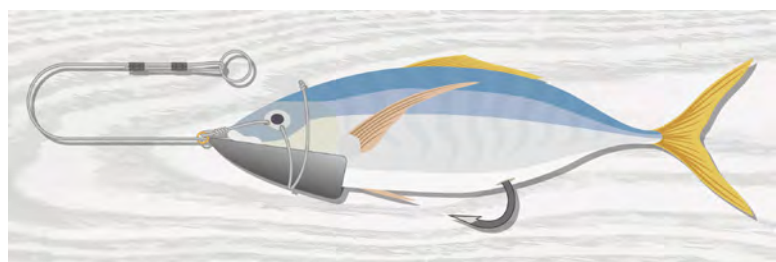

A scad rigged for trolling with one hook.

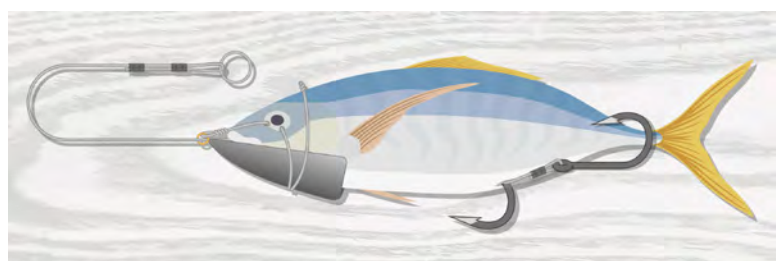

A scad rigged for trolling with two hooks.

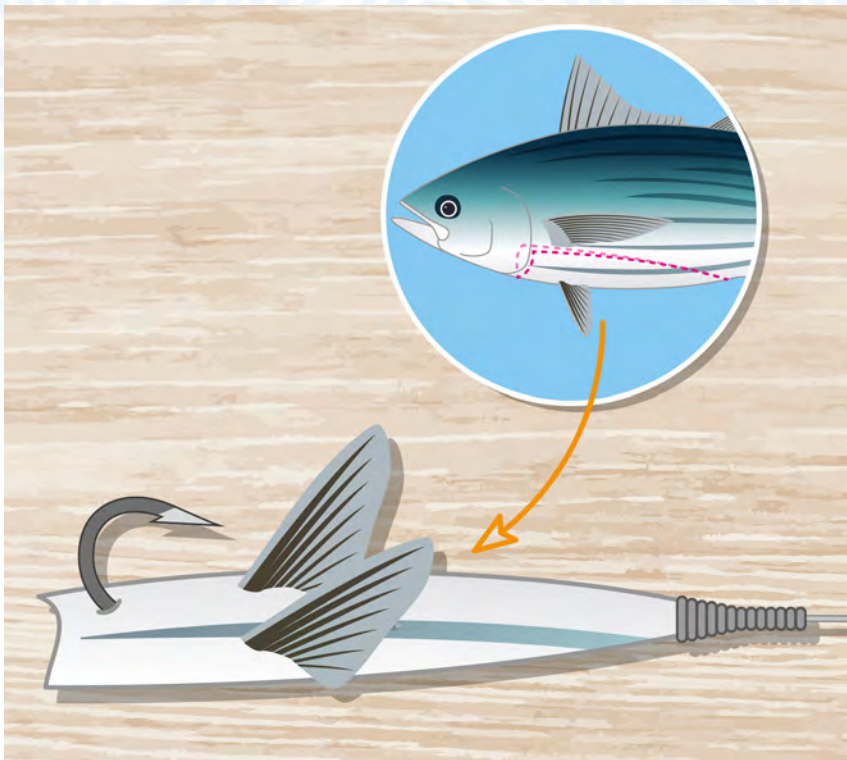

A skipjack belly flap rigged for trolling.

The way to rig natural bait varies and depends on the shape and size of the bait.

You can easily rig bait with a bait needle, which can be made at home from a piece of fence wire, a bicycle spoke or an old knitting needle. The needle needs to be sharpened at one end and have a small eye at the other end. The needle is used to pull the leader through the body of the bait and out through the mouth, so that the hooks can be fed into the right position before attaching any chin weights, or wiring the mouth closed.



Rigging natural bait requires a bait needle, which can be easily made at home.

Making your own gear to rig natural bait

Materials list			
#	Component	Description of material	Amount required
1	Leader	Wire, cable or heavy monofilament	1–2 m
2	Needle	Bait needle such as stiff wire 2 mm to 3 mm in diameter, and between 250 mm and 350 mm long (see diagram above)	1
3	Hook(s)	J hooks are preferable, sizes 7 to 9 O’Shaughnessy or big game hooks. Double hooks are also good for some fish shapes	1–2
4	Sinker (optional)	Lead chin cap, ball sinker, flat lead or bullet sinker of the size appropriate for your bait	1
5	Tools	Wire cutters, pliers, crimps, crimping tool	
6	Tie wire	Flexible copper, brass, Monel or similar wire, ~ 0.5 mm diameter. It must be easily bent and twisted with the thumb and forefinger, not springy, and preferably rustproof.	~200 mm

To make the gear:

- Make a leader as described in [section 5.3 \(p. 54\)](#), using cable, wire, or heavy monofilament.
- If you are making a two-hook rig, refer to illustrations in [section 5.4 \(p. 56\)](#) and to the above and below illustrations).
- If you are using ganged hooks, join the hooks as shown in [section 3.1 \(p.26\)](#).

Rigging the bait

There are multiple ways to rig natural bait.

- Bait that has a flattened shape – such as mackerel or scad – is best rigged with a lead chin cap to prevent it from spinning when trolling.

Here is one example that uses a scad, a single hook and a chin cap.

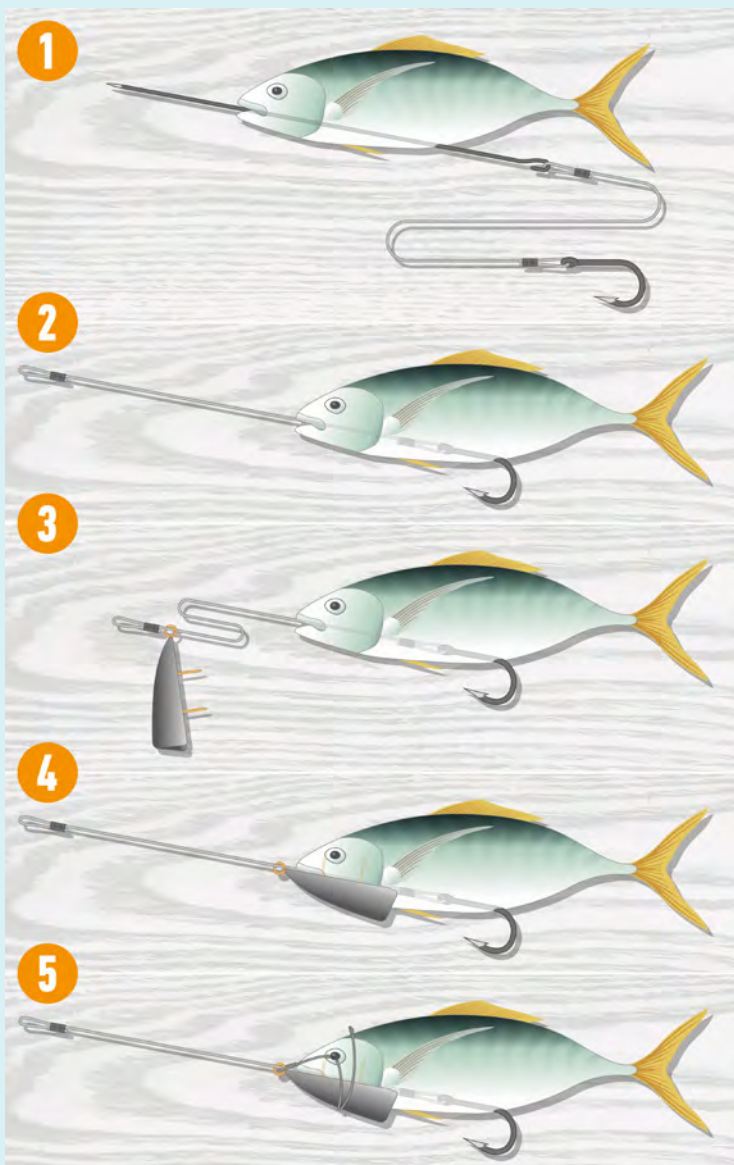

1. Use the needle to thread the leader through the fish.

2. Pull it through until the hook sits just below the fish.

3. Slide a chin cap along the leader towards the fish head.

4. Push the chin cap wires up in the fish head.

5. Fit the chin cap to the fish head using a short length of flexible tie wire.

One of the many methods of rigging natural bait.

Several other methods of rigging bait are described in more detail in the SPC manual *Trolling techniques for the Pacific Islands: A manual for fishermen*.

Natural bait trolling tips

When you are ready to start trolling, attach the leader and bait to the mainline swivel or snap, and ensure that the hooks are not tangled. Then, place the baited hook gently in the water. Check to make sure that the bait swims properly before letting the mainline out to the desired distance from the boat.

- Troll slowly (4–8 kt) when using natural bait, otherwise it may fall apart at higher speeds.
- A good bait swims well, imitating the motion of a live fish, without spinning.
- If the bait spins, snap its spine or squeeze it to loosen the body muscles and improve its motion.
- Prepare your trolling bait the night before you go out fishing. Then, store them on ice or in a fridge (but take enough gear and supplies so that extra bait can be rigged onboard if needed).



An old onion bag filled with food scraps and breadcrumbs works to attract fish.

5.6 Using chum

The purpose of chum is to attract fish to the vicinity of a baited hook and line. This increases the chances of catching a fish. Whether you are trolling with artificial lures or natural bait, chum can be used to attract fish closer to the boat and your fishing gear.

Mesh bags

A cheap and simple way to disperse chum while trolling, is to put it into a mesh bag and tow it alongside the boat. Specially made chum bags can be bought in fishing or hardware stores. But, an old onion bag can also be used.

Canisters

Plastic chum canisters, which are sturdier than mesh bags, can be used in the same way. These can either be purchased, or home-made made from PVC pipe, chicken wire or small-gauge steel mesh. [Section 6.7](#) shows how to make a tough, home-made chum canister from PVC pipe. Although it is intended for mid-water line fishing, it can also be used for trolling.

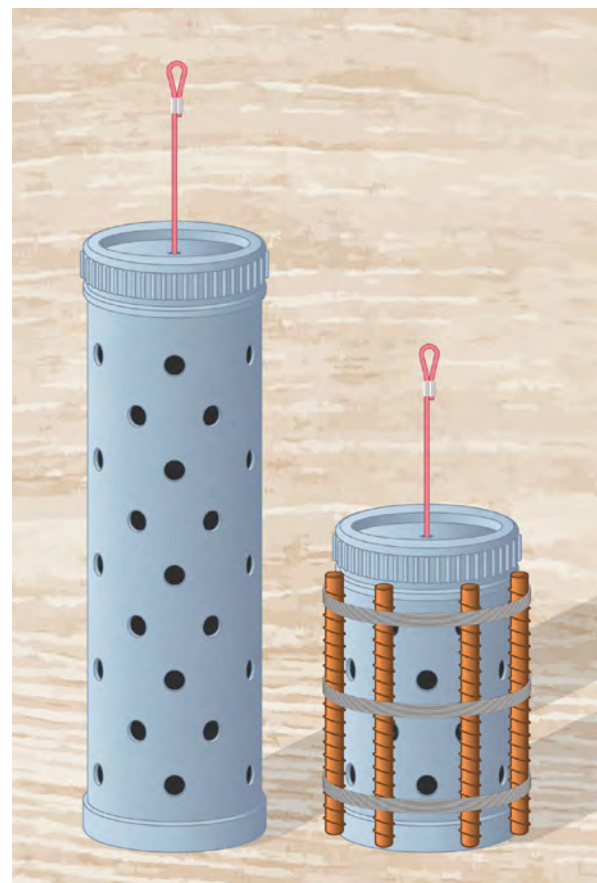

Chum canisters made with PVC pipe.

Towing a chum container while trolling works best if the chum is frozen into a block so that bits slowly break off and disperse in the water as it defrosts.

Dispensers

Some fishers use a metal or plastic chum dispenser (also called a burley bucket) attached to the boat's transom. The dispenser sits partly below the waterline and is perforated so that when chum is dropped inside of it, the water helps disperse the chum. A "chum muncher" can also be used to mash the chum and help disperse it.

An inventive fisher can easily make his own chum dispenser using an old bucket, PVC pipe and pipe caps, chicken wire or other materials.



Home-made chum dispenser for trolling.



A meat grinder makes an efficient "chum muncher".

5.7 Subsurface trolling

Subsurface trolling uses special lures, weights or diving devices to get the trolling line deeper where bigger or different fish can be caught. Depending on the gear being used, it may be possible to tow lines at depths of up to 20 metres.

Subsurface trolling targets many of the same species that are caught when trolling on the surface, including tuna, mahi mahi, wahoo and rainbow runner.

Diving lures – such as bonita, rapala and other types of artificial lures – have a sloping bib front or an angled head section so that water resistance forces the lures downwards. Lures like this typically dart from side to side very actively when being trolled.

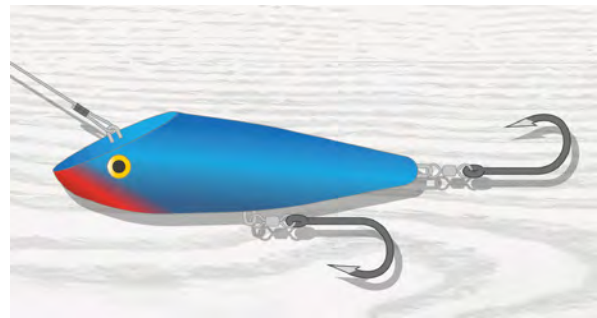

Bonita



Rapala

Two types of diving lures.

Subsurface trolling can also be done using the lures or baits already described for surface trolling, by adding weights or diving devices. With subsurface trolling, you will need to decrease your boat's speed. Going too fast will cause the line to rise to the surface.

Inline sinkers

If using normal lures and bait, the simplest way to get the line deeper is to add a lead or steel sinker. You can purchase these or make your own "inline sinker" by crimping barrel leads onto a length of wire, or a piece of steel rod with eyes welded onto each end.

The sinker is connected between the mainline and the leader, so it needs to be fitted with eyes, swivels and snap clips as appropriate. A 1.0–1.5 kg sinker will get the line to a depth of about 5 m if you troll at 5 kt.

To make your own trolling sinkers, thread several barrel leads onto a piece of cable (or wire), so that they are held firmly in place by crimps and cannot move or slide along the wire. Ensure there is at least 25 cm of wire on each side the barrel leads, so that if a fish decides to bite the sinker it will not damage the leader or mainline.



An inline sinker made with barrel leads.

Diving boards

A diving board is a device which, when properly rigged, acts like an underwater kite, diving down and carrying the bait or lure behind it as it is towed through the water.

When a fish strikes, the board flips over and returns to the surface, making it easier to pull in the hooked fish.

Diving boards come in various shapes and sizes and are generally purchased commercially.

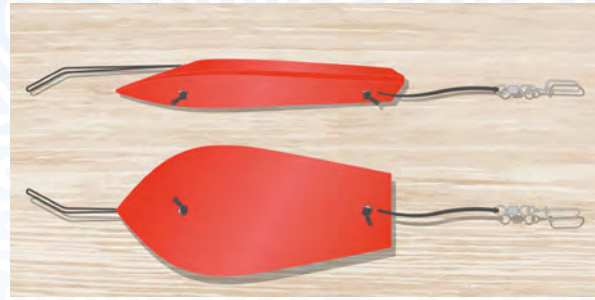

A typical diving board is usually made of wood or hard plastic.

The diving board is attached to a snap or corkscrew swivel at the end of the mainline, while the leader and lure or bait are attached to the trailing edge.

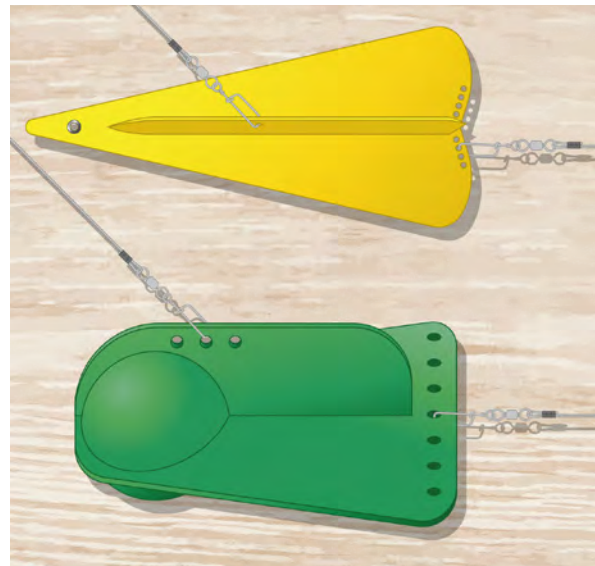

Diving boards come in various shapes and sizes.

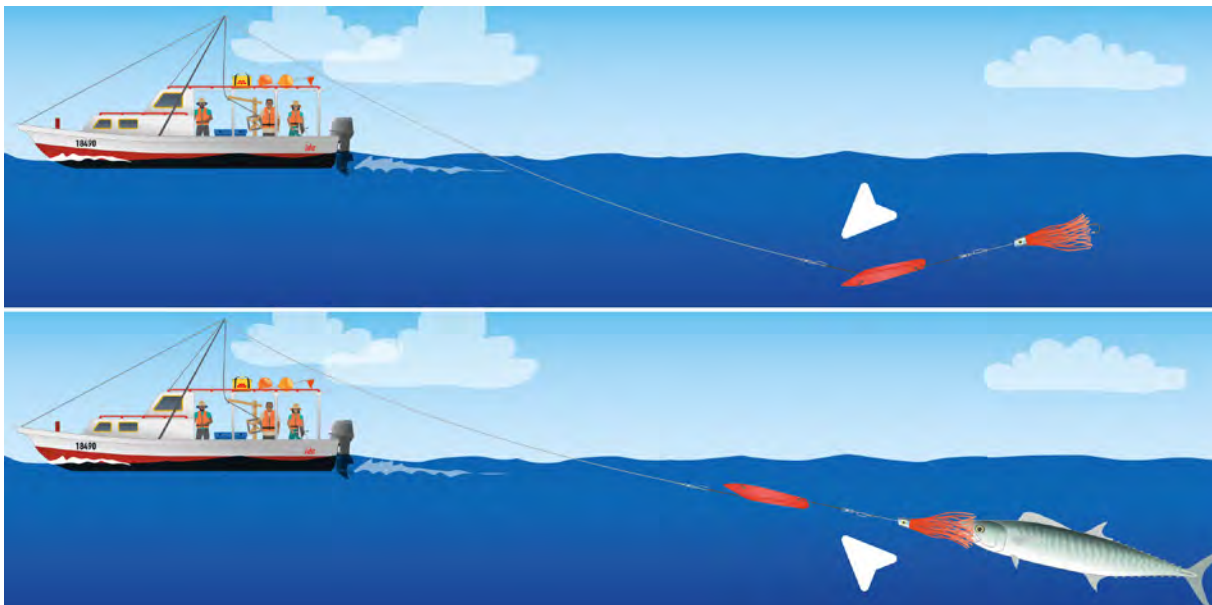

A diving board flips and comes to the surface when a fish strikes.

Some diving boards have two or three different attachment points for the mainline. These different attachment points allow you to choose whether the board dives deeper or shallower. Some boards have multiple towing points at the trailing edge where the leader can be attached. Using an off-centre towing point will cause the board to veer off to one side or the other, which helps to keep the lines separated from one another if you are trolling with multiple lines.

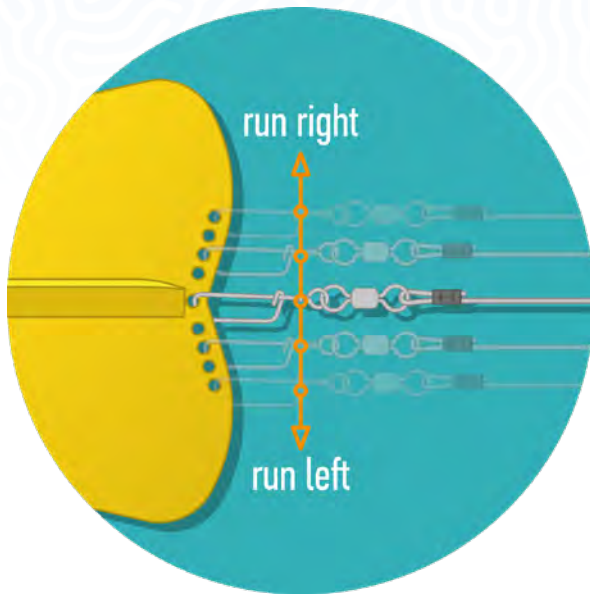

Attachment points used to veer off the diving board to the left or right.

Diving boards take the bait or lure deeper than an inline sinker, but need to be trolled at low speeds such as less than 5 kt. If you troll much faster than this, the board may start to malfunction, swinging into other lines and tangling them, or returning to the surface at high speed and then skipping across the water.

When operated correctly diving boards create a lot of downward pull, so make sure the mainline, swivels and clips are strong enough to take it.

Downriggers

A downrigger - sometimes called a cannonball sinker - is a very heavy weight that is towed behind a boat and used to take the trolling line down to deeper depths. In its simplest form, a downrigger can be any heavy object, but a purpose-made lead downrigger with proper attachment points is much better. The best downriggers also have a vane on the back to stop them from spinning around while they are being towed.

Unlike inline sinkers and diving boards, downriggers need to be set and hauled on a separate line of their own. The downrigger can be set and hauled in by hand and cleated off to the boat at the right depth, or it can be rigged onto a separate hand reel, which makes setting, hauling and measuring the depth a lot easier.

When using a downrigger, attach the trolling mainline to a quick-release clip, which lets go when a fish strikes.

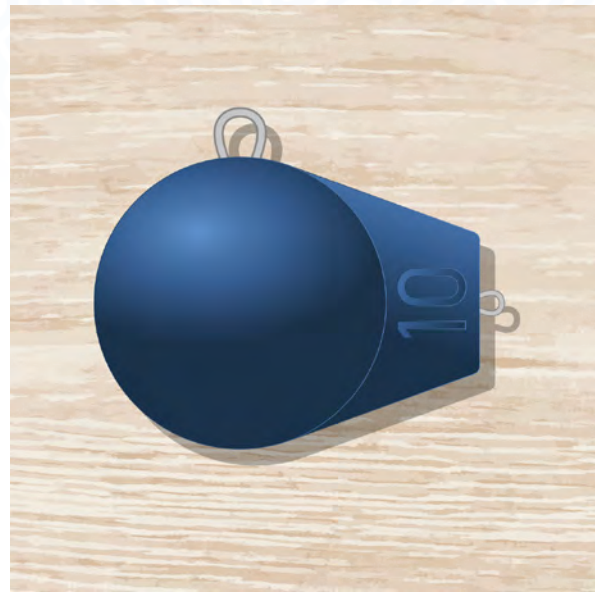

A cannonball with a vane on the back.

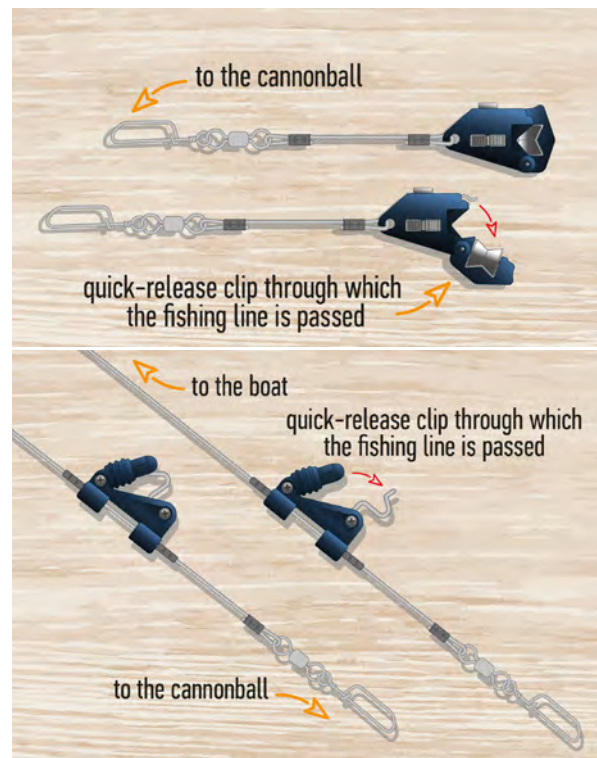

Two commercial models of quick-release clips.

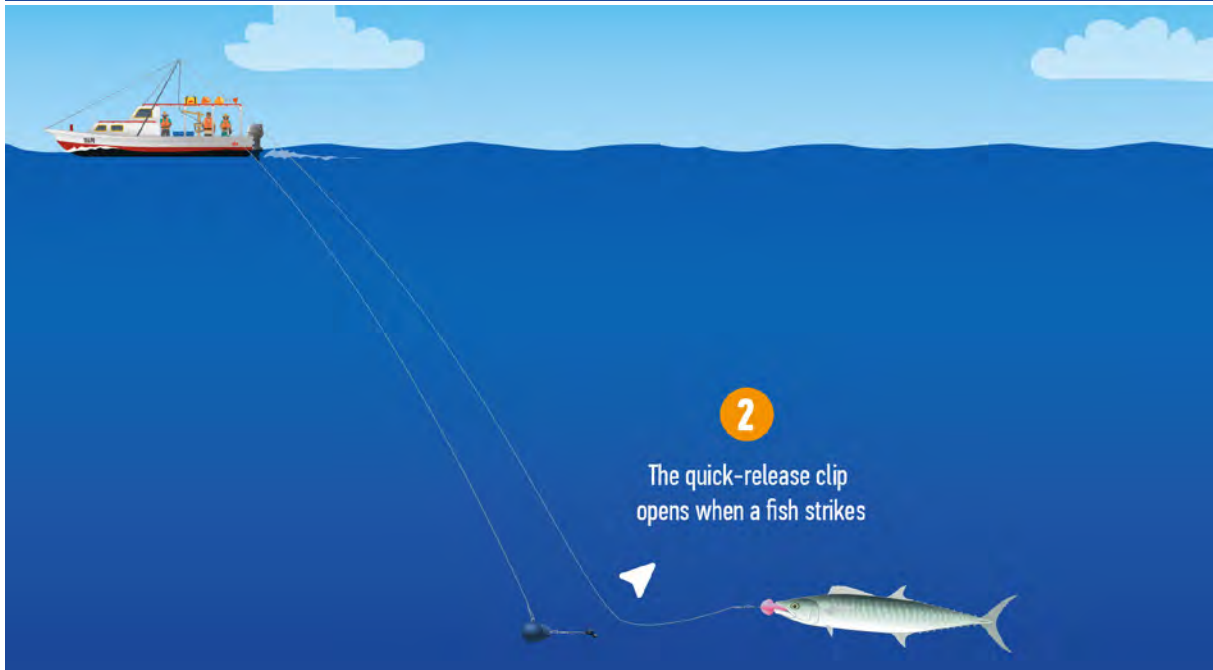
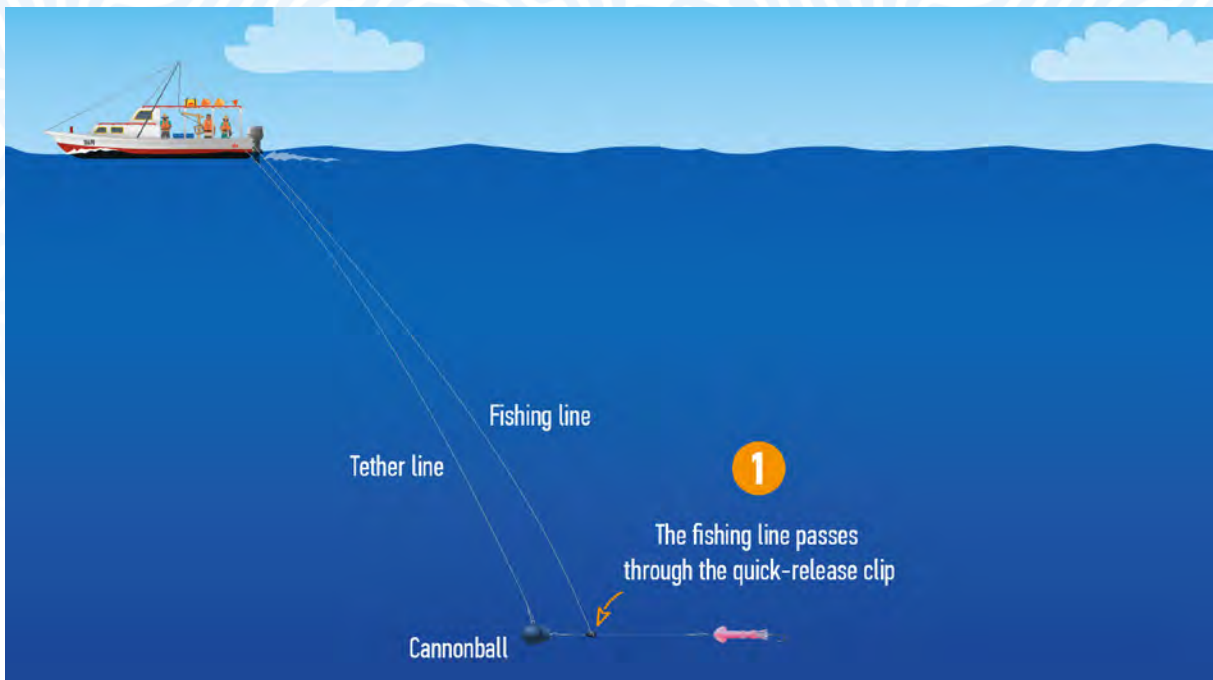

Using a cannonball and a quick-release clip to troll deeper.

Two or more lures can be trolled from the same downrigger at various depths if the lures are attached to separate, well-spaced release clips. But, there is always a chance of the lines tangling if two fish strike different lines at the same time.

One type of diving board, often called a paravane, can also be used as a cannonball with a quick-release clip.

A paravane used with a quick-release clip.



Using diving devices

The various diving arrangements that have been described will result in lines fishing at progressively greater depths.

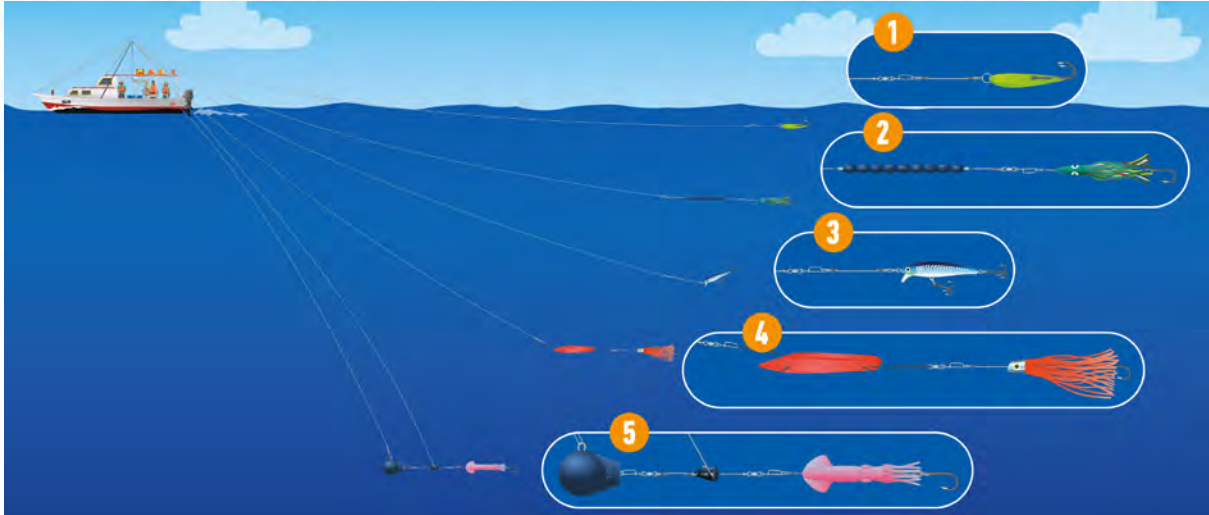

Lures or natural bait can be set at increasing depths using:
1: a monofilament mainline only; 2: an inline sinker; 3: a diving lure; 4: a diving board; 5: a downrigger (cannonball).

Trolling lines equipped with inline sinkers or diving lures are used in the same way as for surface trolling.

- Make sure the lure or bait is swimming correctly and the hooks are not tangled; then, pay out the line gently, bait first.
- Troll at a moderate speed of less than 5 kt, depending on the type of lure or bait being used.

Diving boards are used the same way, but need a bit more care.

- Feed out the lure or bait followed by the leader; then, ease the diving board into the water.
- Be ready for a strong pull when the board dives down; control it and check that it is swimming correctly.
- When everything looks good, pay out the mainline.
- Troll at a moderate speed of less than 5 kt.
- Exercise caution when retrieving the diving board or diving lure because they can leap out of the water when they are being hauled in.

Downriggers are complicated diving devices to use.

- Pay out the lure or bait about 20–25 m.
- Pass the trolling mainline through the quick-release snap on the downrigger.
- Slowly lower the downrigger while at the same time releasing the main trolling line; keep enough tension on the trolling line to avoid the line from the spool from running out.
- If you use more than one trolling line, attach them with at least 2 m of spacing between them.
- When the downrigger line is taut, set the reel drag to strike, and haul in the slack from the mainline.
- After a strike, pull the cannonball in first, before attempting to pull in the fish; this is necessary to prevent a hooked fish from swimming around the downrigger line and becoming tangled with it.

Important: Always wear gloves when handling trolling lines and retrieving downriggers.

5.8 Using trolling booms

Trolling booms, also called outriggers, are long poles that allow trolling lines to be spread apart from both one another and away from the boat. This reduces the chances of the lines becoming tangled, allows more lines to be used, and increases the area of water that the trolling gear covers.

Booms can be used for both surface trolling and deep trolling in the same way as described in earlier sections of this chapter.

But, a trolling line fixed to the end of a trolling boom, or part-way along it, will be out of arm's reach when in use. This problem is easily solved by using a "lazy line". The lazy line allows the mainline to be retrieved and hauled in when a fish is caught, or after fishing. A lazy line consists of a length of cord or rope with a loop at the end; the mainline is passed through the loop before the lure and leader are attached.



A lazy line is used to retrieve a fixed trolling line attached to the end of a boom.

Trolling boom construction

Trolling booms can be made from a variety of materials, including fibreglass poles, lengths of bamboo, sawn timber or metal piping. The size will depend on the material and the length of the boom, but 5 cm diameter is typical.

Boom ends need to be fitted with strong attachment points. If trolling lines are operated from reels, then a pulley must be fitted so that the line can be paid out and wound back in as needed. If fishing lines are fixed to the boom end, rope loops and shackles can be used.

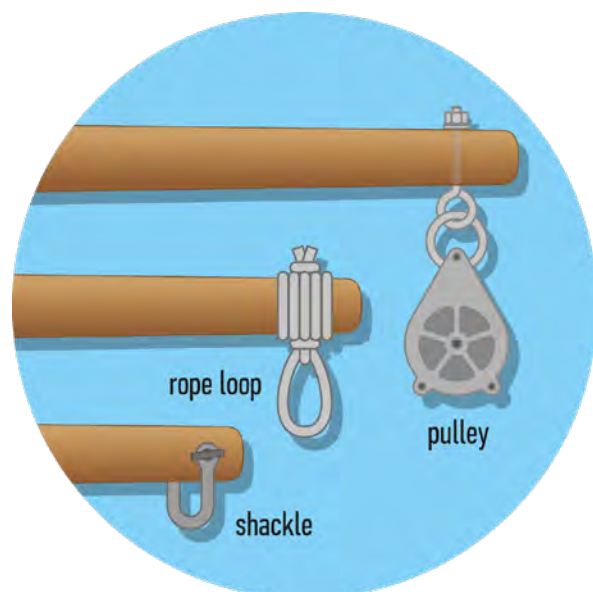

Boom end attachment points.

Mounting the trolling boom

Although trolling booms are fairly simple, you will need to take care in how you mount them.

- The booms greatly increase the width of the boat during fishing operations, and this is very undesirable when the boat returns to port. When fishing is over, the booms should either be stored away, or hinged so that they can be swung (usually upwards) out of the way.
- The force of a big fish striking a line at the end of the boom is huge and could easily break the boom. Some materials (such as carbon fibre) are strong and flexible enough to take such a shock, but booms made from most other materials need to be fitted with forestays and backstays, and possibly top and bottom stays, to help them take such shocks.

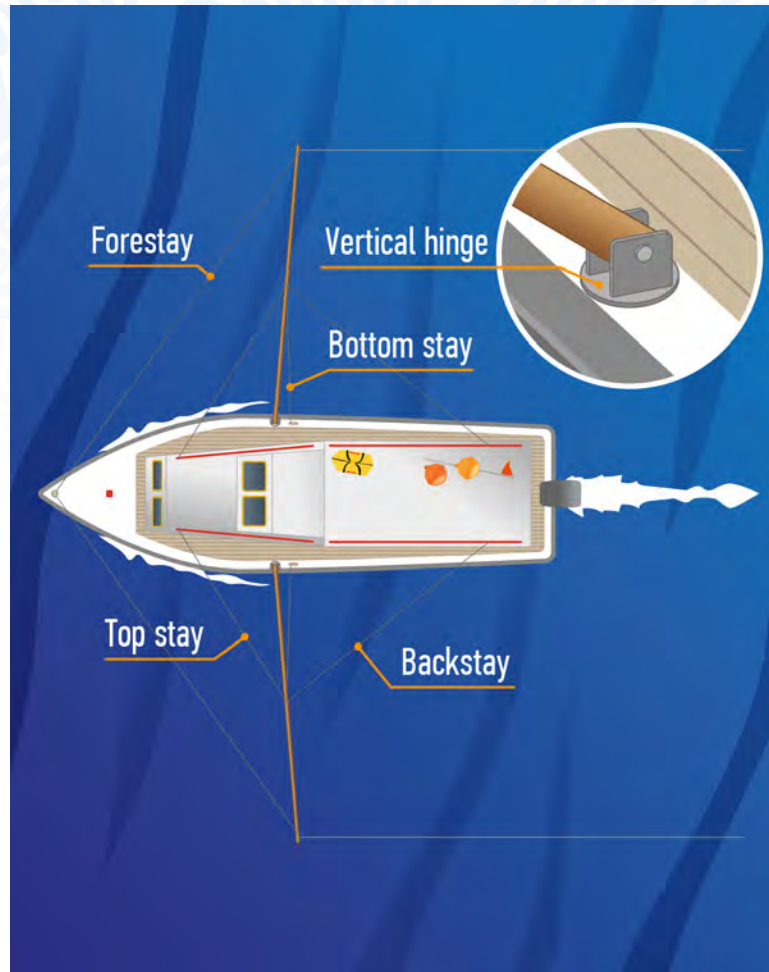

Vertical hinge allows boom to be swung up when not in use.

6 Mid-water line fishing

6.1 Mid-water line fishing basics

Tunas and most other pelagic fish spend part of their time swimming in water that is a hundred or more metres deep. Various fishing methods are used to capture these fish by positioning a baited hook at the right depth, sometimes along with a “cloud” of chopped up fish or other chum to attract the fish to the hook.

Mid-water line fishing is probably the simplest way to catch tunas and other oceanic fish. Apart from the line itself, most mid-water fishing methods use natural bait, so a knife and cutting board are needed, as well as heavy gaffs, a fish club, a blood knife and an ice box or ice bag. Bait used for mid-water fishing include skipjack tuna, scads, sardines, garfish, squid and flyingfish.

Fishing gear

Basic mid-water line fishing gear consists of a long (~100–400 m) mainline with a 5–10-m leader. The leader is attached to the end of the mainline with a strong snap swivel and a baited hook and, if needed, a sinker. The preferred hooks are sizes 13/0–16/0 tuna circle hooks or something similar. While the gear that is used for some mid-water line methods is quite similar, it does vary.

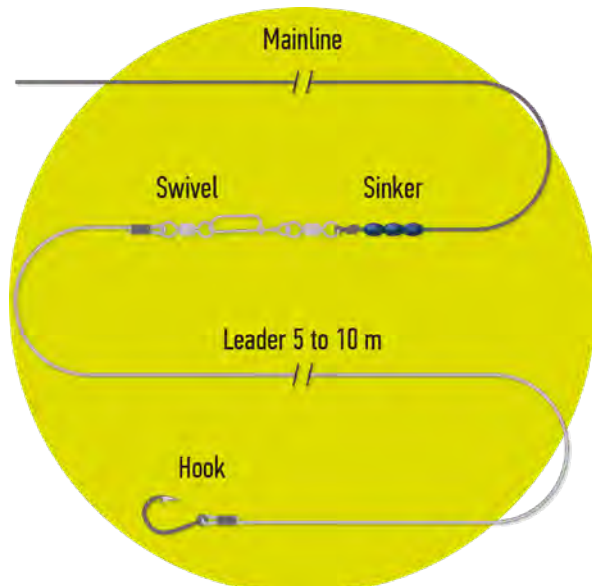

Basic mid-water fishing line.

The mainline can consist of a number of materials. Monofilament nylon with a breaking strain of 50–150 kg is the most common, but other materials include braided lines such as “Super Toto”, Dacron cord, or

Kuralon™ longline rope (see [section 3.3](#)). The choice of material depends on whether you use fishing reels. For example, braided line is fine if used on a fishing reel, but it can cut fingers, and tends to tangle when it is hauled in by hand. Kuralon™ is easy to use when hand-hauling, but it is too bulky to load onto hand reels.

The leader should be monofilament nylon with a breaking strain that is less than that of the mainline.

The line is usually weighted with a sinker. In a strong current, a sinker of 1 kg or more may be needed, while in a weak current, a lighter sinker of 100–200 g may be the right choice. If you are drifting in a light current, it may be possible to fish with no sinker at all, especially if a leaded swivel is used in the line.

Some fishers tie pieces of thread at intervals along the mainline, so they can easily see how much line has been paid out. Tying dental or waxed floss in a string of half-hitches is a good way to do this. Permanent marker pens can be used to colour the floss. Knots should never be used to mark a line because knots will create weak points and cause the line to break.

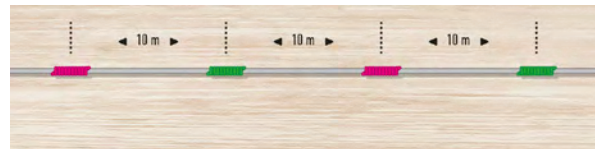

Dental floss can be tied onto the line at measured intervals and marked with different colours to indicate depth.

The best way to store a mainline is on a reel or spool that is kept in a crate, as shown in [sections 2.2 and 3.4](#). Some fishers like to flake their lines into baskets or buckets, but this can lead to tangles when a fish suddenly takes the bait and makes a run.

Using your gear

Mid-water line fishing gear can be simple, but the fishing operation itself still requires plenty of skill. Like other fishing methods, mid-water line fishing works best if the boat is kept stationary relative to the current, either by drifting (if there is no wind), or by using a parachute sea anchor (see [section 2.4](#)). Fishing is typically best around FADs.

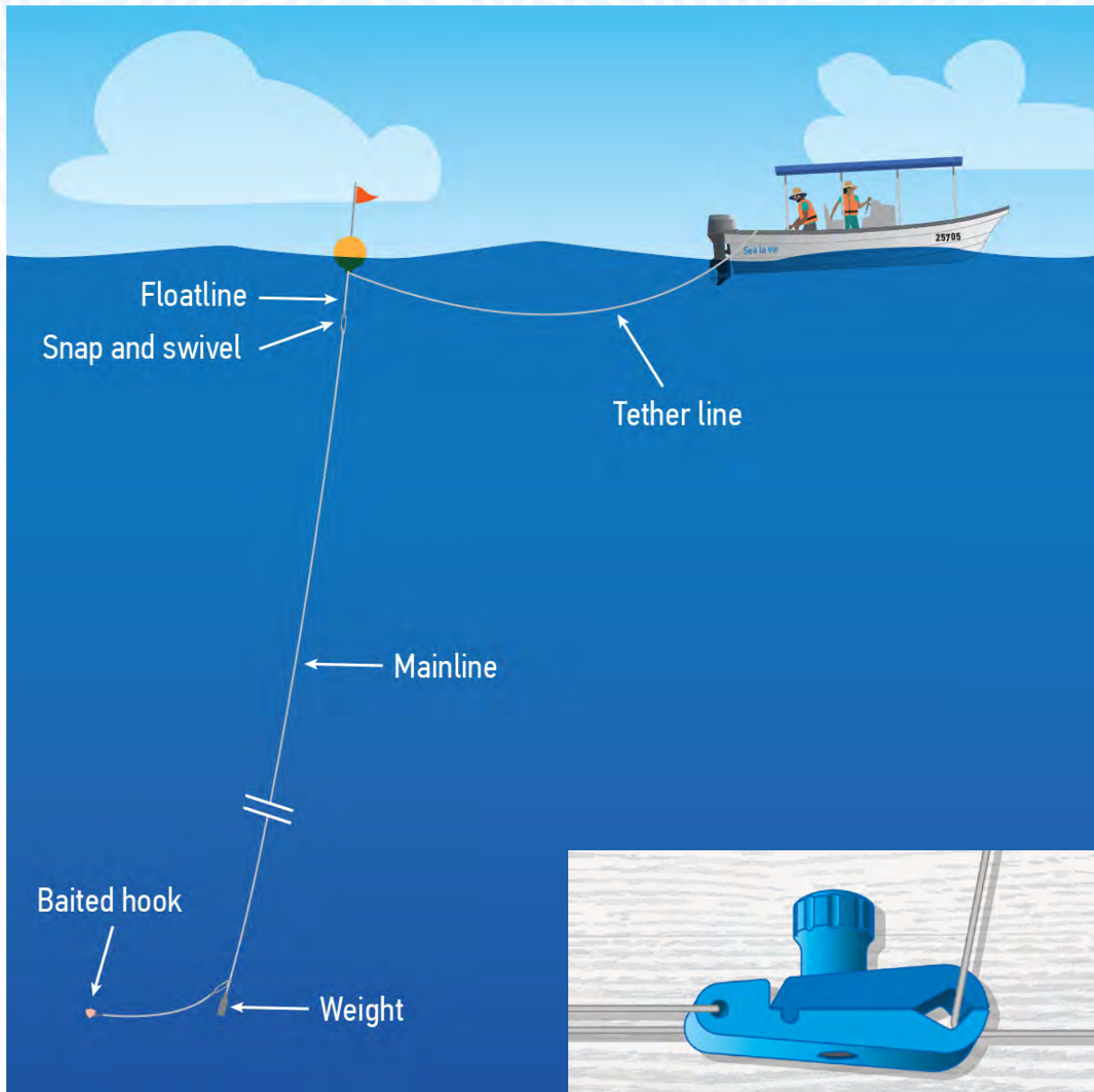

A mid-water handline attached to a float

In its most basic form, mid-water handline fishing is done by lowering a baited hook into the water to the desired depth, and then waiting. You can either hold the line so that you can react quickly to a strike, or you can attach it to a rubber snubber or quick-release clip. Various kinds of quick-release clips are available commercially ([section 5.7](#)), but you can also make one yourself using a clothes peg.

Some fishers attach a float to the mainline. The fishing line is paid out to the desired depth and then buoyed off on a tether line that is a few metres long. When a fish strikes, the float provides resistance but not enough to cause the line to break. This tires the fish out until it can be brought onboard.

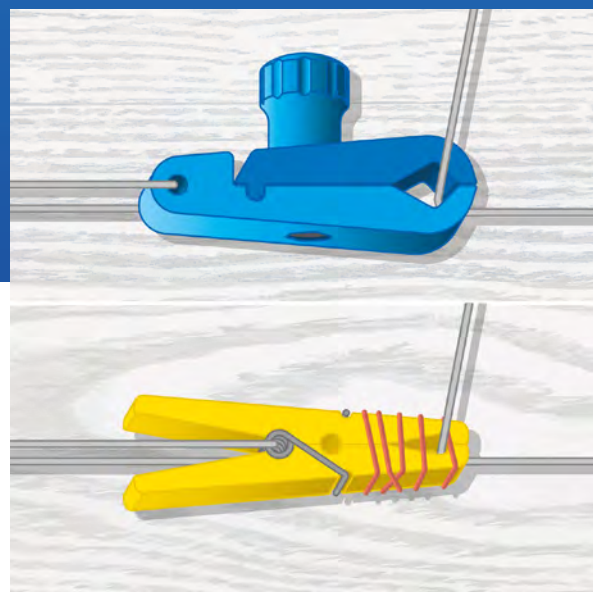

A commercial quick-release clip and a home-made one.

This kind of fishing can also be done by letting the floatlines drift away from the boat. By doing this, a single vessel can fish several lines at a time, especially if operating away from a FAD where there is less danger of the lines tangling with the FAD. Drifting lines are carried by the current.

6.2 Drop-stone fishing

A specialised variation on the mid-water line fishing method is called drop-stone fishing. This style of fishing is used in many Pacific islands.

In drop-stone fishing, the bait hangs naturally in the water, and no permanent weight is attached to it.

But, the bait still needs to reach deep water, so a temporary sinker is used to take the hook to the desired depth and then releases when it is no longer needed. The sinker is normally a stone that weighs 1–2 kg. On atolls where there are no river stones, you can use a small giant-clam shell (about 15–20 cm long) instead. But, use clam shells that are already dead, rather than harvesting live ones!

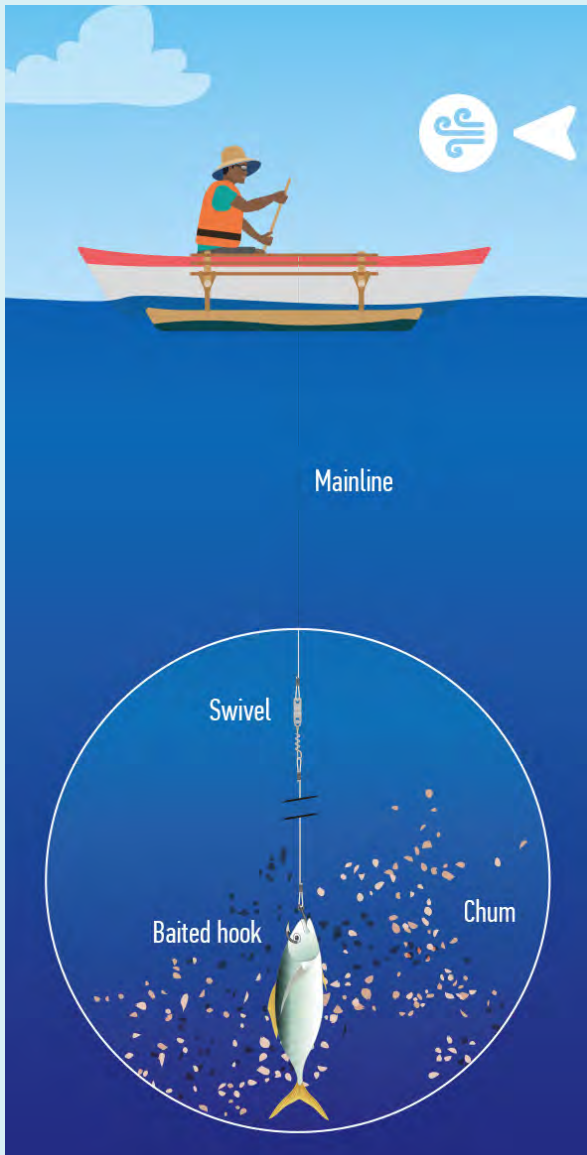

Drop-stone fishing from a paddling canoe.

Equipment and materials needed



1. Mainline with a corkscrew or snap swivel
2. Leader: 2–6 m of 40–90 kg breaking strain monofilament
3. Curved hook:
 - Tuna circle hook, size 12/0–14/0; or
 - Japanese tuna hook, size 3.6; or
 - Large “J” hooks, or
 - O’Shaughnessy, size 7–8; or
 - Swordfish hook, size 7/0–11/0
4. A small bait fish or a piece of bait
5. Chum
6. A smooth stone about 1–2 kg, or a dead giant clam shell (1 per drop)
7. Optional: large leaves from a breadfruit or Barringtonia tree (1 large leaf or 2 small leaves per drop)

Barringtonia leaves are slightly poisonous and must be handled with care.

Basic drop-stone package

This fishing method requires a supply of stones that are the correct size and shape. Rounded stones with one flat side, about twice as long as wide, and weighing 1-2 kg, are best. If stones are not available, dead giant clam shells can be used instead.

There are several ways to prepare the bait package. A common method is shown in the illustration below.

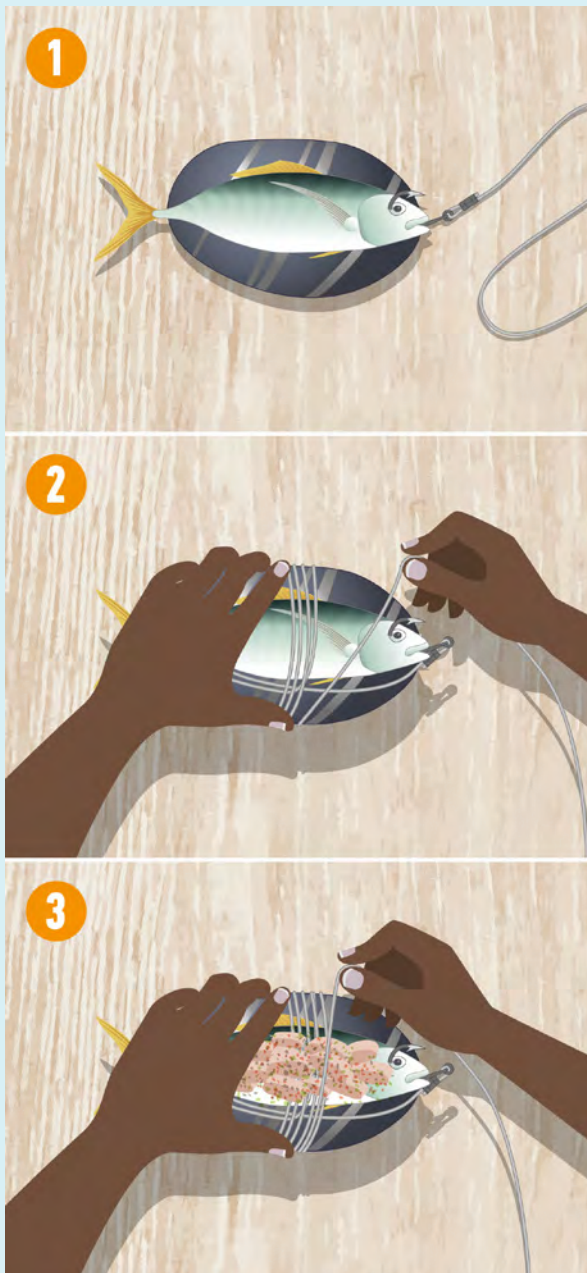

1. Place the baited hook on the flattest side of the stone.
2. Take a few wraps of leader line around it to hold it in place.
3. Place pieces of chum on top of the bait, a few at a time with more wraps of leader line taken around them each time.

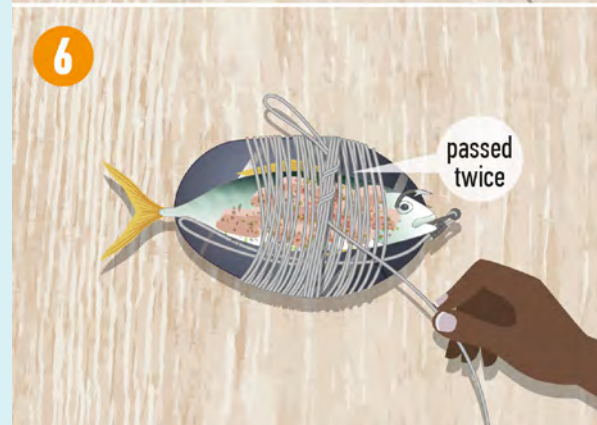
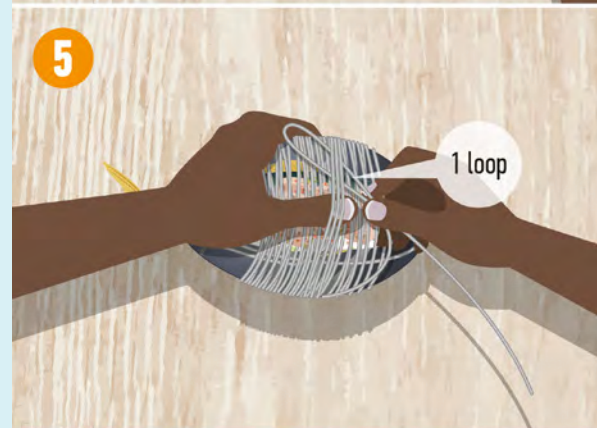
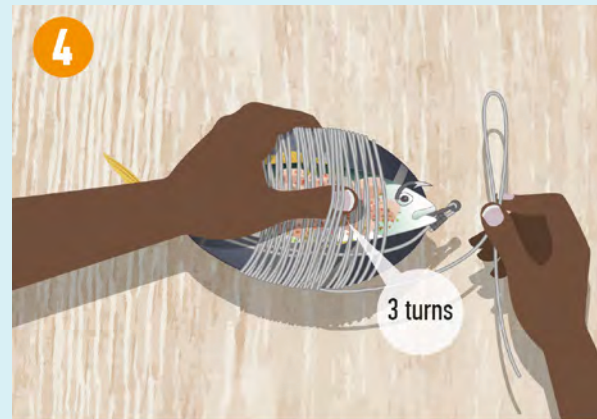

4. Repeat until the leader forms a tightly bound package. Make 3 more wraps over your thumb.
5. Form a loop and pass it under the 3 wraps.
6. Pass the loop a second time under the 3 wraps and pull on the end of the loop to tighten the whole package.

The tightly wrapped leader will hold the loop in place until the fisher releases it with a quick tug.

Leaf drop-stone package

Some fishers like to wrap the bait and chum in a wide leaf and then wrap this bundle onto a stone or inside a clam shell as shown in the illustration below. This prevents the chum from escaping before the package reaches the desired fishing depth.



1. Place the baited hook on the leaf.
2. Place pieces of chum over the bait.
3. Fold the leaf over the bait and chum.

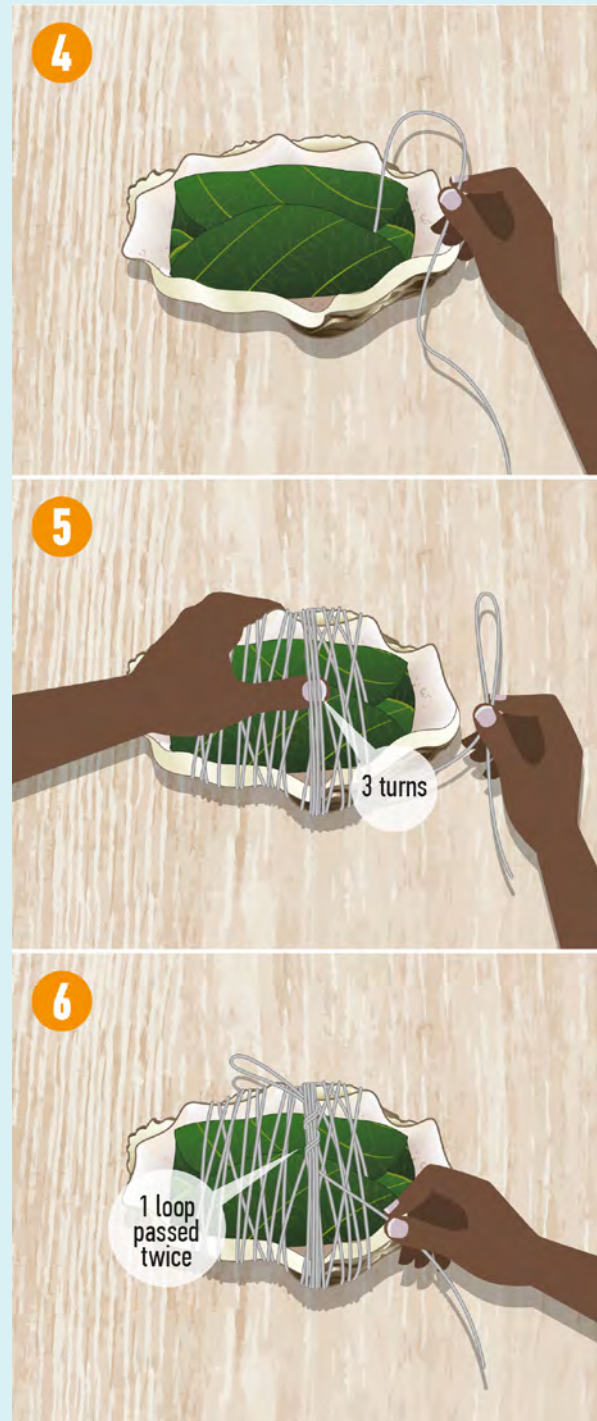

4. Place the package in a clam shell or on a stone.
5. Take several wraps of leader line around the shell/stone to hold the package in place and make the 3 last wraps over your thumb.
6. Form a loop and pass it twice around the 3 wraps. Pull on the end of the loop to tighten the whole package.

The tightly wrapped leader will hold the loop in place until the fisher releases it with a quick tug.

Using the gear

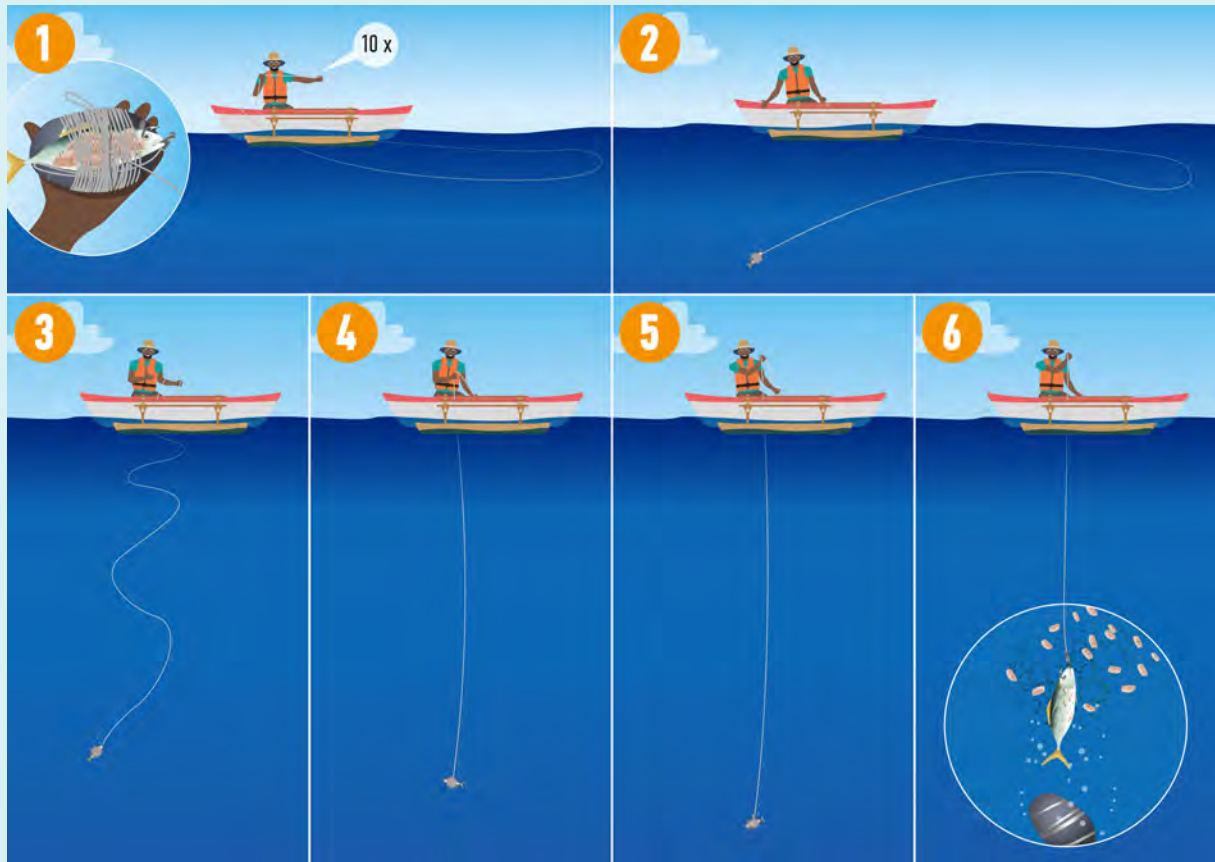

Once the parcel has been prepared, make sure the line is cleared to run out without obstruction before the parcel is dropped over the side of the boat. And, once the bait parcel is dropped over the side of the boat, make sure you pay out the line smoothly so that it does not catch on the boat or fittings; otherwise, it may get jerked open too soon.

1. Pay out 10 m of slack line using your arm span.
2. Drop the parcel gently in the water.
3. Keep feeding out the line, monitoring the depth with the dental floss marks (see section 6.1). Make sure not to slow or stop the line too early as it could jerk the package open by accident.
4. Gently stop the line when you have reached the desired depth.
5. Give several sharp tugs to the line to...
6. Release the bait and the chum while the stone sinks freely away.

Drop-stone fishing tips

- Wash your hands with soap and water before preparing the gear in order to remove any traces of

fuel, oil or sunblock, as these may put off the fish from taking the bait.

- Do not let the slip knot stick out more than 3–5 cm beyond the edge of the wrapped leader. A long loop can become caught around the stone, prevent the parcel from being released when it is jerked. If this happens, you will have to haul in the parcel and re-tie it.



A correctly wound slip knot.



If the loop sticks out too far it may wrap around the stone and fail to release.

6.3 Palu-ahi fishing

Palu-ahi fishing is a modern Hawaiian version of the traditional drop-stone method; it is also called “make dog” in Hawaii, from maki dougu, the Japanese name for this method.

Palu-ahi fishing uses chum to attract fish to a baited hook. The mainline is rigged with a square cloth, a lead weight and a leader with a hook attached. The lead weight, chum and the leader with its baited hook are wrapped inside the cloth as a parcel and deployed to a desired fishing depth, the line is jerked and the parcel unravels, allowing the chum to flow down-current to attract fish to the baited hook.

Palu-ahi fishing is like drop-stone fishing, but with some key differences. A square piece of cloth is used instead of a leaf, and a flat-shaped lead weight replaces the stone sinker. And, unlike in drop-stone fishing, the sinker is not released while fishing.

Equipment and materials needed

- A. Mainline, 50–150 kg breaking strain with a snap or corkscrew swivel at the end
- B. Leader, 2–6 m of 40–90 kg monofilament

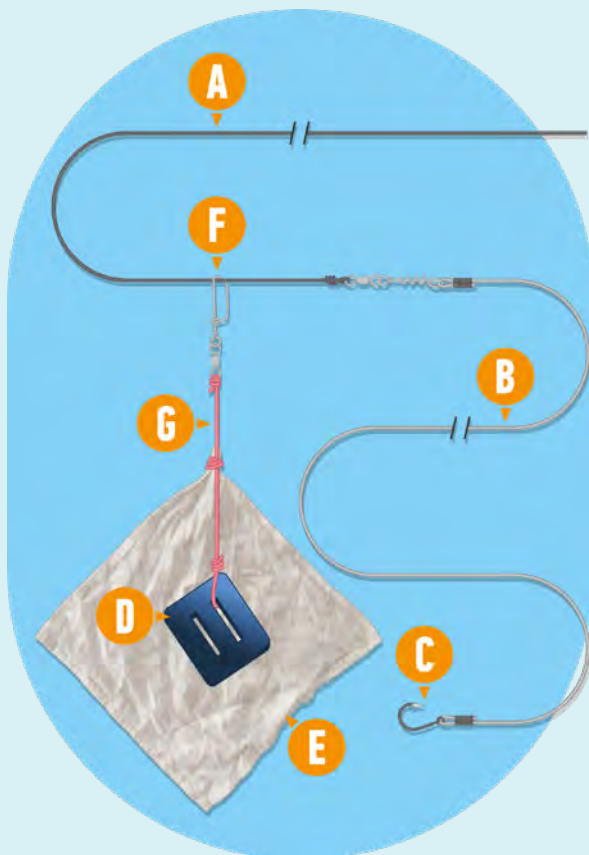

- C. Hook. Good choices include:
 - Tuna circle hook, size 13/0–16/0; or
 - Japanese tuna hook, size 3.6; or
 - “J” hooks. O’Shaughnessy, size 7–8; or
 - Swordfish hook size 7/0–11/0.
- D. Flat lead sinker, 1–2 kg
- E. Square cloth made of denim, canvas or any heavy cloth; 25–30 cm square; dark colour preferable
- F. 9/0 snap swivel to attach to the cloth and sinker
- G. Monofilament or braided line, 25 cm length x about 1.5 mm diameter

And, of course, you need bait and chum. Suitable bait includes whole small scads or mackerels, tuna chunks or other fish fillets.

Making the gear

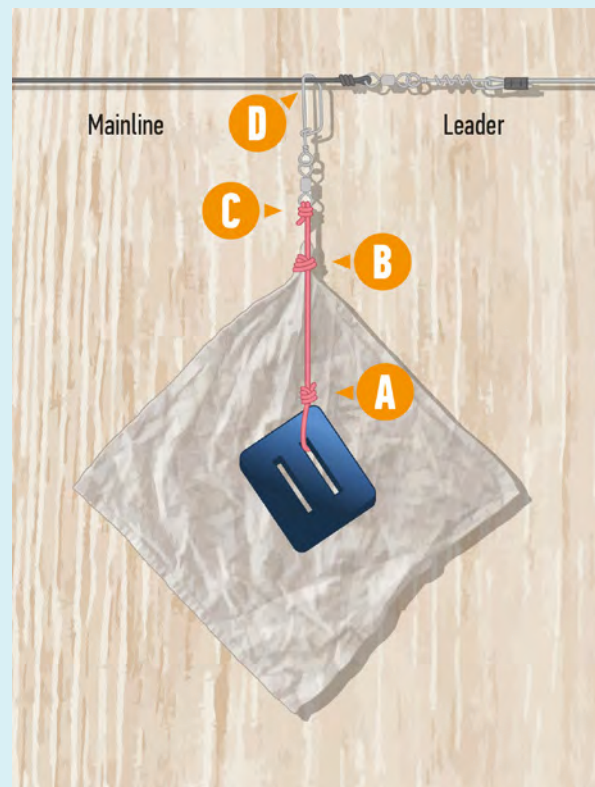

Attach the 25 cm of monofilament or braided line to:

- A. the lead weight;
- B. one corner of the cloth so the weight lays in the centre of the cloth;
- C. the snap swivel; and
- D. clip the snap swivel onto the mainline so that the weight and cloth can run freely along it, but not past the swivel that links the mainline and the leader.

Preparing the palu-ahi parcel

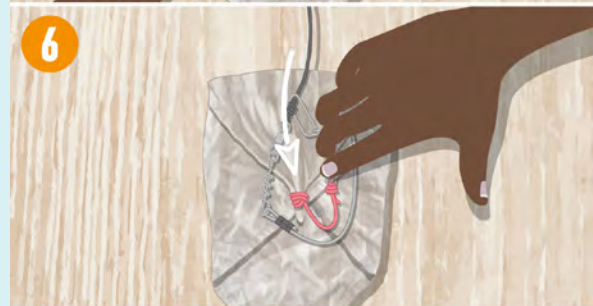

1. Coil the leader and place it under the weight.
2. Place the baited hook on top of the weight.
3. Add chum on top of the baited hook.
4. Fold the right corner of the cloth on top of the weight, bait and chum.
5. Fold the left corner over the right one.

6. Fold the top corner over the first two and place the 2 swivels over the centre of the package.
7. Fold the bottom corner of the cloth so it covers both swivels.
8. Wrap the mainline several times and pass a loop twice under 3 wraps, as explained in [section 6.2](#).

Using the gear

Using palu-ahi gear is similar to the way drop-stone gear is used.

1. Pay out about 10 m of line and then deploy the parcel.
2. Keep paying out line and do not stop the line as the parcel descends to the desired depth.
3. When the parcel has reached the desired depth, vigorously pull several meters of the mainline back up in order to slip the knot on the parcel, and let it open up.

The main difference from the drop-stone method is that, in palu-ahi fishing, the lead sinker is not released; instead, it remains attached to the end of the mainline. This means that jerking the line to release the package does not cause the leader to be unravelled and straightened out. Instead, when the package comes undone, the leader will still be hanging in loose coils and slowly unfurling.

To speed up the process of unfurling and reduce the chance of tangles, you need to pull several meters (a bit more than the length of the leader) of mainline in quickly in order to make the leader straighten out.

Because the line still has a heavy weight attached to it, the mainline will tend to hang almost vertically while the leader, which is unweighted, will stream out with the current.

Palu-ahi fishing tips

- This fishing method works best when a sea anchor is used to minimise drifting.
- After the leader has straightened itself out, slowly slack the mainline to allow the bait to remain among the chum for as long as possible.
- Unclip the sinker and cloth from the mainline as soon as it is hauled aboard. Otherwise, if the fish makes a run, the sinker could be dragged around, injuring somebody or damaging the boat.



6.4 Cone-bag fishing

A baited hook and chum are placed in a cone-shaped cloth bag fitted with a lead sinker. The cloth bag is wired shut and dropped to the desired fishing depth, where a sharp tug on the line releases the baited hook and chum.

Equipment and materials needed

1. Longline clip and swivel
2. Copper or stainless-steel wire, 15–20 cm long x 1 mm diameter
3. Monofilament or braided line, about 50 cm long x 2 mm diameter (200 kg test)
4. Rolling or crane swivel, size 9/0
5. Lead sinker 1 kg or heavier moulded with the swivels at the top end, shaped to fit in the top part of the cone bag
6. Cone bag made of light cotton, nylon or polyester cloth, preferably of a dark colour
7. Monofilament or braided line, 0.5–1 m long x 2 mm diameter (200 kg test)
8. Rolling or crane swivel, size 9/0
9. Hard plastic slat, of around 12 cm length by 6.5 cm high to fit in the cone bag, with a centre hole drilled vertically through the slat
10. Monofilament leader line, 6–15m of about 40–90kg test
11. Round bead or lead sinker, which acts as a stopper for the slat
12. Hook. Good choices include:
 - Tuna circle hook, size 14/0–16/0; or
 - Japanese tuna hook, size 3.6; or
 - Large “J” hooks, or
 - O’Shaughnessy, size 7–8; or
 - Swordfish hook, size 7/0–11/0



Making the gear

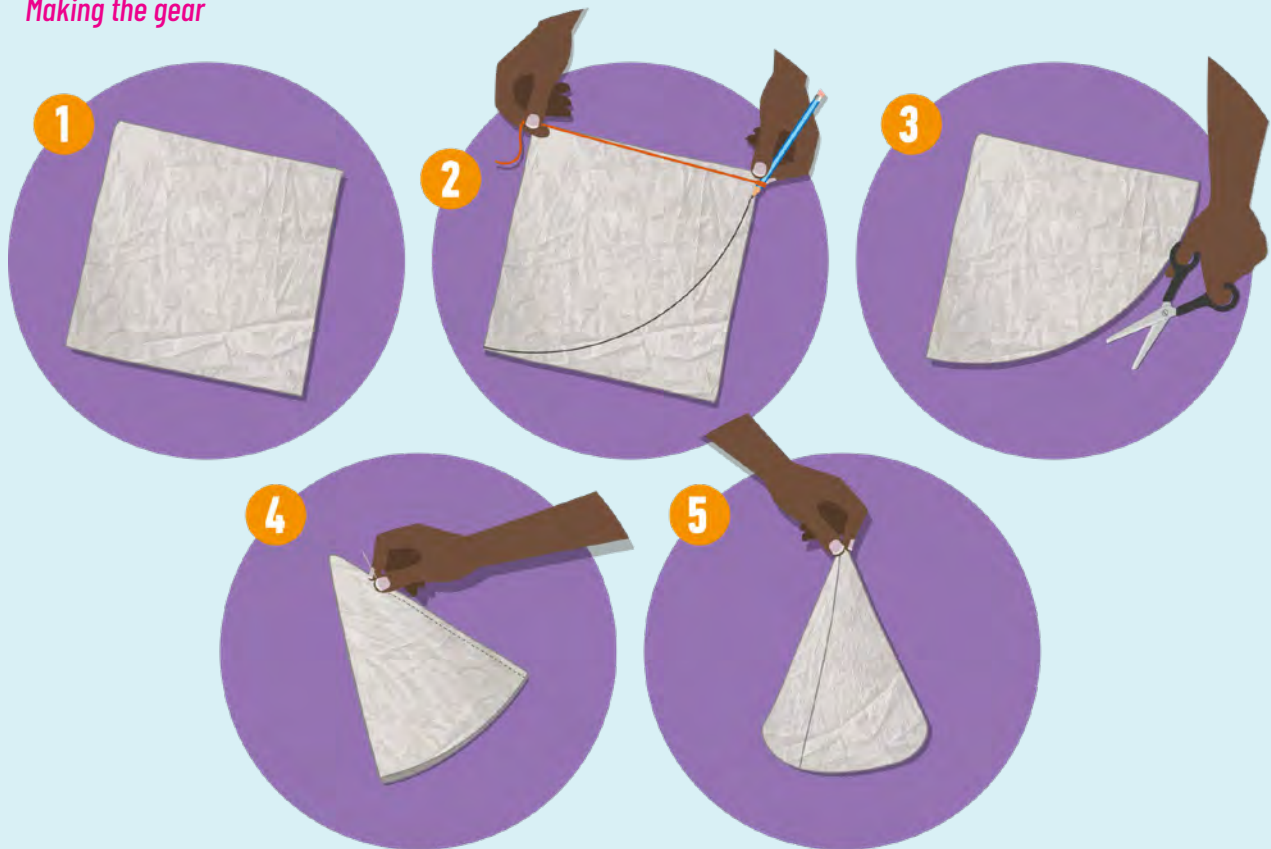

Follow these steps to make the cone bag:

1. Lay flat a square piece (45 cm x 45 cm) of light fabric cloth.
2. Use a piece of string to pencil an arc between opposite corners.
3. Cut along the arc.
4. Fold in half and stitch the straight edges together.
5. Turn the cone inside out to place the stitched part inside.

Use a flat sinker or banana sinker ([section 6.8](#)) with a strong swivel set at one or each end. You can make your own sinker using an old sardine can as a mould.

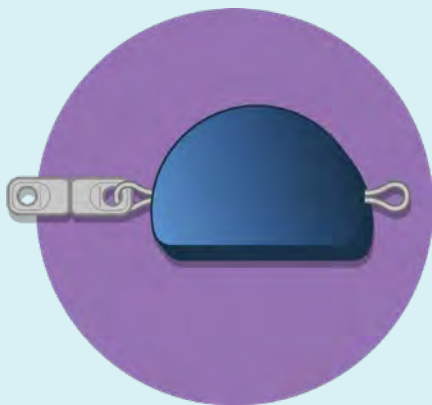

Lead sinker with one barrel swivel.

The slat is a piece of wood, metal or plastic on which the leader can be wound. It can be round or flat.



The slat made of wood, steel or plastic should be around 12 cm long by 6.5 cm high.

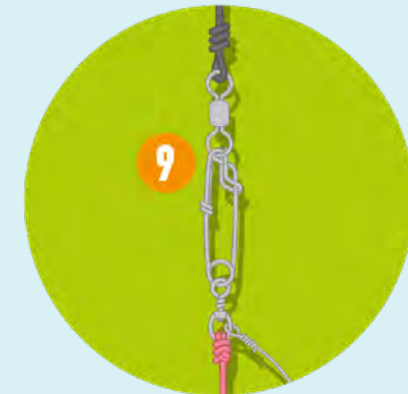
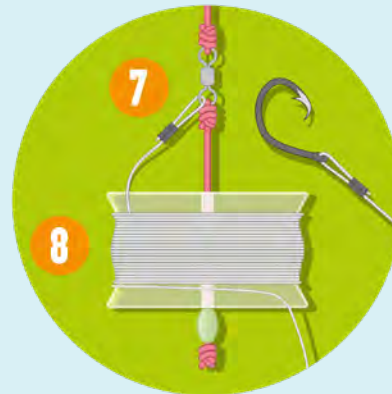
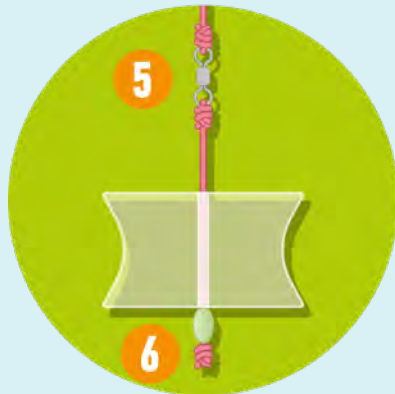
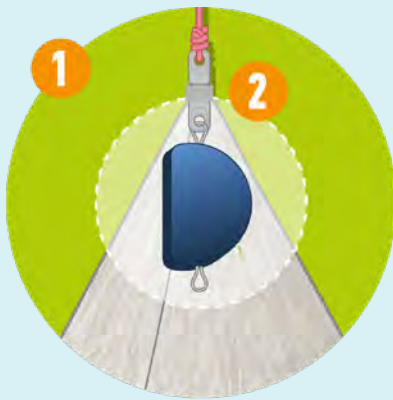

To assemble the gear, follow the steps below.

1. Place the lead weight inside the cone bag with the swivel protruding out of the top of the cone bag.
2. Firmly attach the top of the cone bag to the bottom half of the swivel with whipping twine.
3. Attach a longline snap at the top and twist the copper or stainless-steel wire in the eye of the longline snap swivel.
4. Attach the monofilament or braided line to the bottom of the lead weight.
5. Add a swivel and a short tie which passes through the hole in the slat.
6. Add a round bead or lead sinker, which acts as a stopper for the slat.
7. Connect the leader to the swivel above the slat.
8. Coil the leader onto the slat.
9. Attach the longline snap to the mainline swivel.

Using the gear

The cone bag needs to be filled and closed as follows:

1. Hold the cone bag with the opening upwards.
2. Add chum on top of the lead weight.
3. Place the slat with the wound leader on top of the chum.
4. Place the baited hook on top of the slat.
5. Close the bag using the copper or stainless-steel wire. To make sure it will unwrap easily, start from the end of the wire and make 2-3 wraps towards the swivel as shown in the illustration.

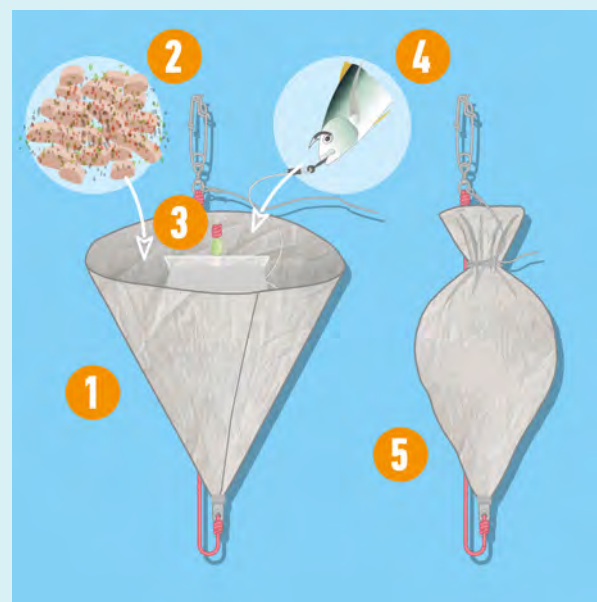

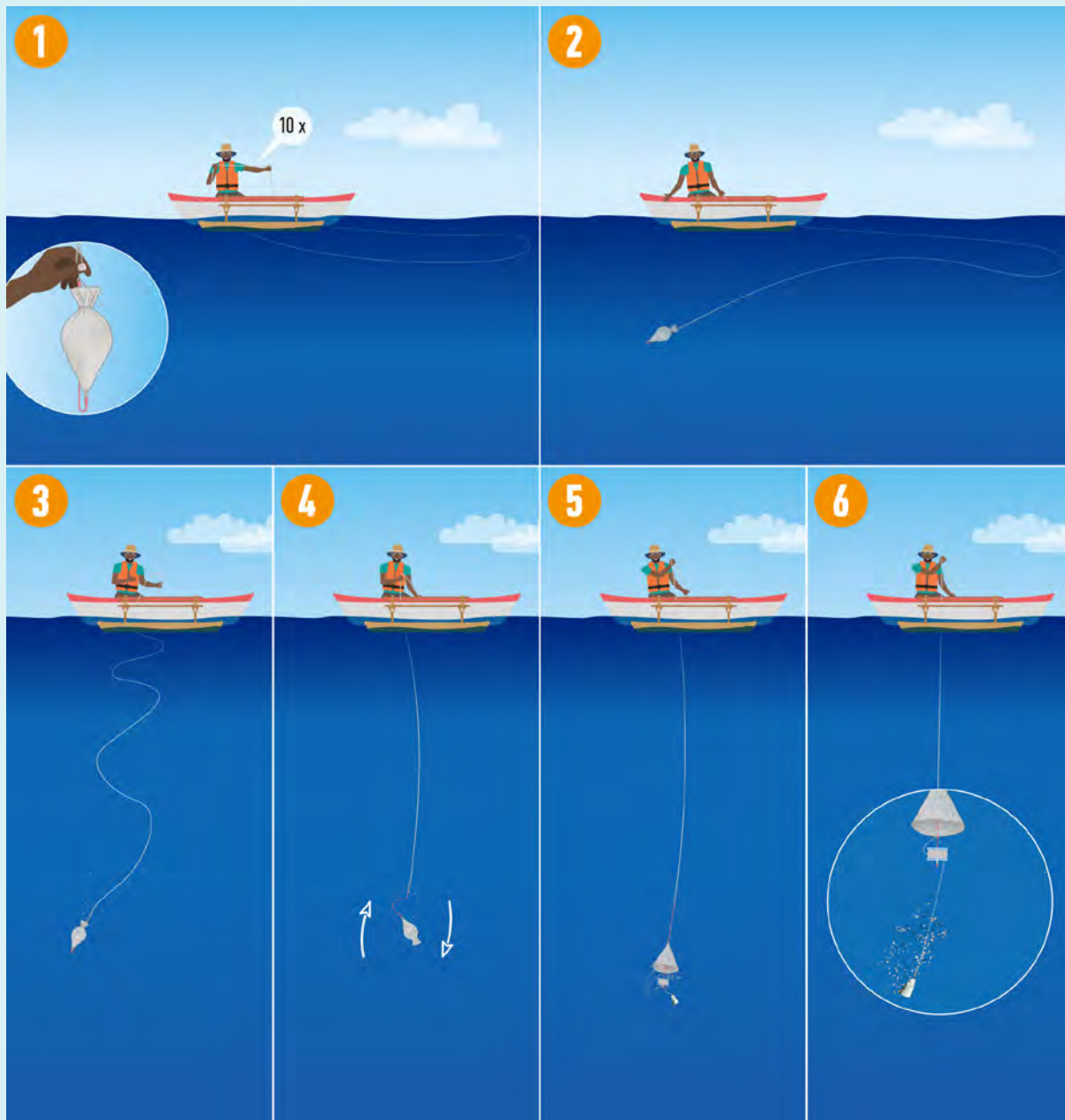

Once the cone bag has been baited and tied, it is ready:

1. Pay out at least 10 m of line.
2. Carefully place the parcel in the water and let it sink.
3. Quickly pay out enough mainline to get to your desired fishing depth.
4. When the parcel has reached that depth, vigorously pull up 5 m of the mainline to force open the mouth of the cone bag. This will allow the baited hook, slat and chum to fall out of the bag.
5. Do not let the line go slack again, otherwise the bag will get tangled with the unwinding leader.
6. The leader with the baited hook will gradually unwind from the slat, with the sinking chum.

Cone-bag fishing tips

- If a slat is unavailable, you can use a leader that is less than 5 m long. To reduce the risk of tangles, wind the leader in a figure 8 pattern around your little finger and your thumb before placing it in the chum bag.
- Use a sea anchor to slow your vessel's drift, so that the line hangs vertically in the water while you are fishing.
- If you cannot make the sinker described above, use a dive weight with swivels crimped or tied onto opposite corners of the weight.

6.5 Spreader-rod jigging

This fishing method is intended for catching tuna and large pelagic fish in mid-water depths, or for catching snappers and reef fish on the deep seafloor or reef drop off. The gear is made from a length of steel rod or stiff fence wire, with a swivel attached to each end and a lead sinker attached about one-third of the length of the stiff wire.

The upper end of the rod, closest to the sinker, is attached to the mainline, while the other end is attached to a 1–3-m leader carrying either an artificial lure or a baited hook. When the rig is placed in the water and the mainline is jigged up and down; the rod intensifies the jigging movement and makes the lure or bait dart around in a way that attracts predatory fish.

The rig can be modified by dividing the rod into two sections that are linked together by “eyes” twisted into the end of each piece. Some fishers believe this improves the performance of the gear, and makes storage easier because the split-rod is more compact.

Equipment and materials needed

1. Spreader rod, made of semi-malleable steel, about 1 m long x 2.5 mm in diameter
2. Sinker, 300–800 g, fixed at one-third of the spreader rod length
3. Snap with 6/0 crane or rolling swivel
4. Leader, monofilament, 1–3 m, about 40–90 kg test
5. Lure or bait
6. Hook. Preferably a J-hook such as:
 - Shaughnessy, sizes 7–8; or
 - Swordfish hook, sizes 7/0–11/0

Making the gear

- Attach the sinker about 30 cm from one end of the spreader rod, and ensure that it is locked in place.
- Attach a swivel to each end of the spreader rod.
- Connect the mainline to the top-end swivel.
- Connect the leader line to the bottom end swivel.
- Attach the lure and hook to the end of the leader.

Your spreader rod is ready to use!

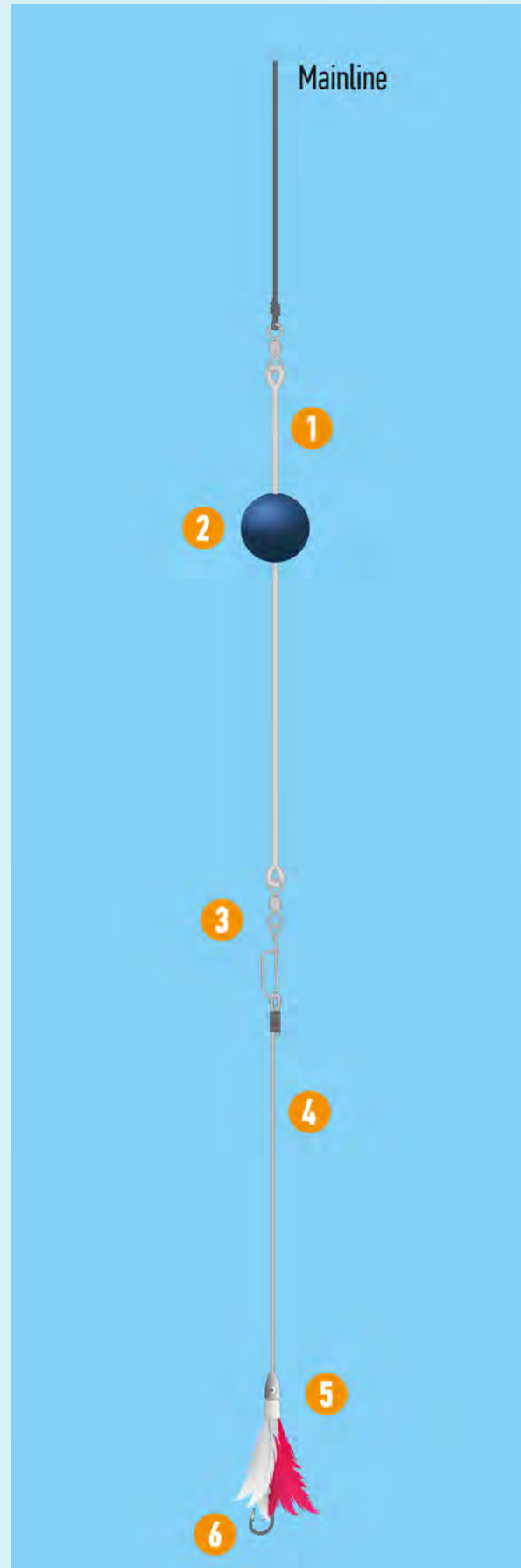

Using the gear

The rig is dropped down to the desired depth and then hauled back in using a jerky up-and-down motion. The spreader rod increases the jerky motion of the lure or baited hook.

Spreader rod jigging can be done in combination with other mid-water fishing techniques that use chum. The spreader rod line must be down current from the other lines to benefit from the dispersed chum.

This method, however, can be very tiring on your arms after a while. Using a fishing rod to create the jerking movement can make the work easier.

A wooden hand reel can be modified to make it better for jigging. You can do this by shortening two of the reel arms so that they are about half the length of the other arms. This way, when the reel is turned, it hauls in the line with a jerking motion.

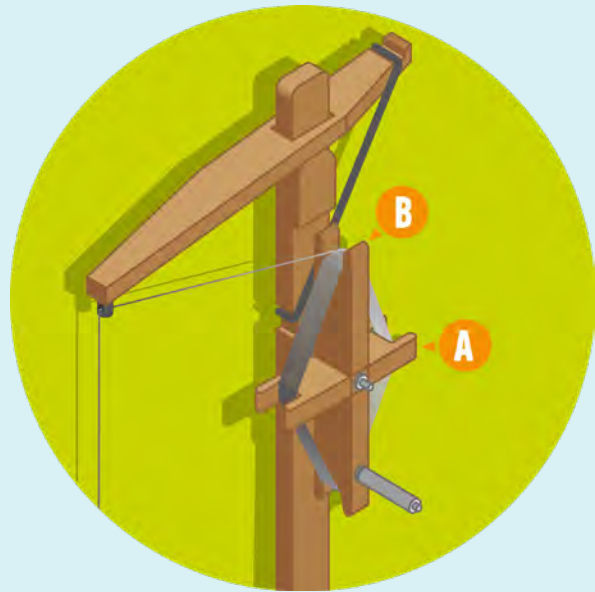

Reel arms A are half the size of arms B to produce a jerking motion when hauling the line.



At night, a glow bead can attract fish to the baited hook.

Spreader-rod jigging tips

- The best time of day to use this method is early morning up to 10:00, and then again in the afternoon, starting at 15:00.
- Spreader-rod jigging can also be done at night by fitting a luminous tube or glow-bead at the top of the hook.
- Spreader-rod jigging works well when used with the palu-ahi technique or other methods that rely on chumming. If some crewmembers use palu-ahi, others can jig with spreader rods at the same time.
- If no fish strike, try changing lures to see if that makes a difference.

6.6 Simple soft float and self-righting float drifting lines

Drifting lines make it possible for a small-boat fisher to simultaneously operate several mid-water fishing lines. Some mid-water fishing lines can be fished from the boat while others are left to drift. Drifting lines can consist of a simple mainline wound onto a purse seine foam float or, of an innovative system that includes a bi-colour hard plastic float, a quick-release clip, and a handcaster. This latter variation allows the fisher to position the baited hook at a desired depth and to be alerted by the bi-colour float when a fish is caught.

Equipment and materials needed

Simple soft float drifting line:

- a. Purse-seine (EVA) foam float
- b. Monofilament nylon mainline of around 30 m long x 1-1.5 mm in diameter
- c. Corkcrew or snap swivel

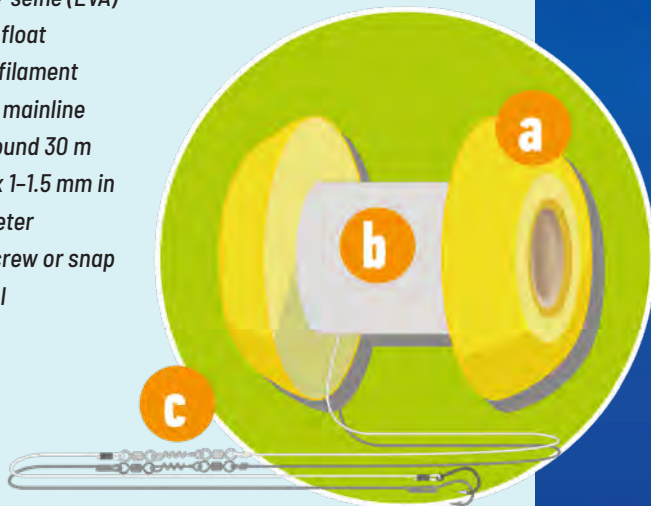

1. Hard plastic ABS float, 24 cm in diameter, painted in two bright contrasting colours
2. Braided line or cord, 1 m x 4-6 mm in diameter
3. Short length of stainless-steel wire
4. Quick-release clip
5. Longline snap and swivel, size: 12.5 cm
6. Backing cord, 1-1.5 m long x 2 mm in diameter
7. Handcaster, 25 cm in diameter
8. Mainline, monofilament, 200-300 m long x 1.5-2.0 mm in diameter
9. Swivel with snap (a lead swivel can be added on top of the snap swivel)
10. Either: simple leader with baited hook, or drop-stone (section 6.2), palu-ahi (section 6.3) or cone-bag (section 6.4) rigs, without the mainline

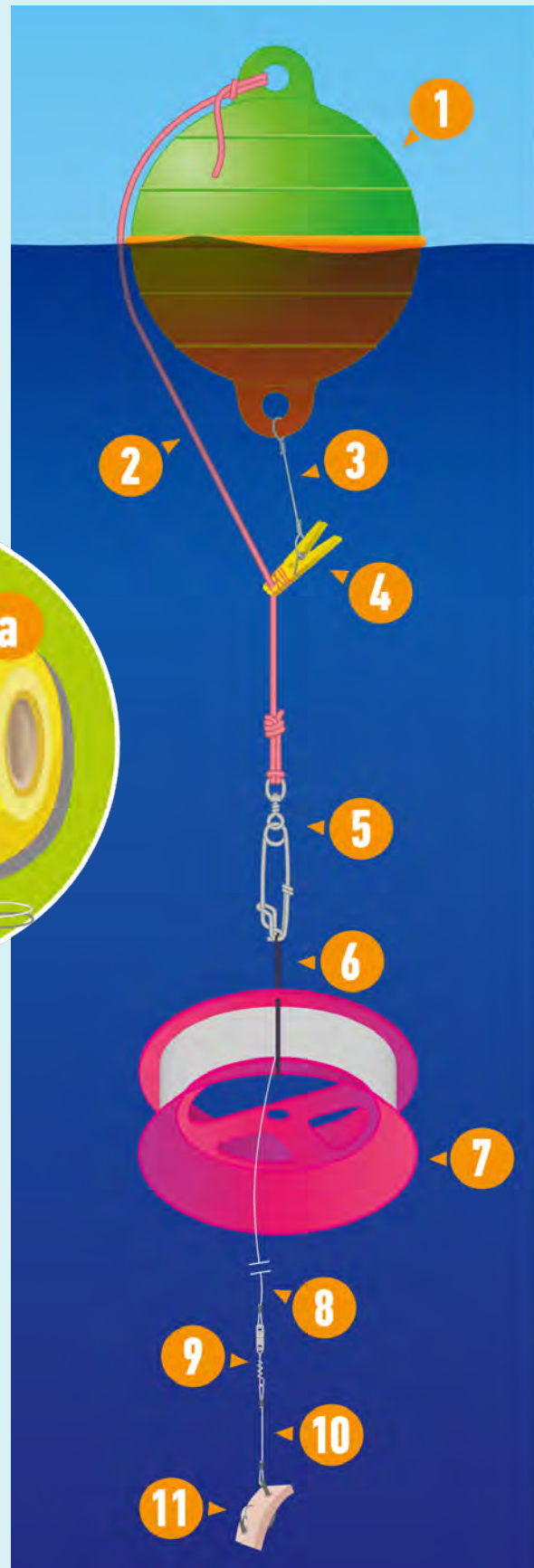

Making the gear

Simple float drifting line:

1. Use a purse-seine soft float.
2. Gouge out the centre of the float.
3. Smooth all surfaces.
4. Secure with a knot and wind on 20–30 m of mainline ended by a corkcrew or a snap swivel.
Connect a leader and hook to the snap.

Optional: an additional lead swivel can be attached about 10–15 m in the mainline above the snap swivel.

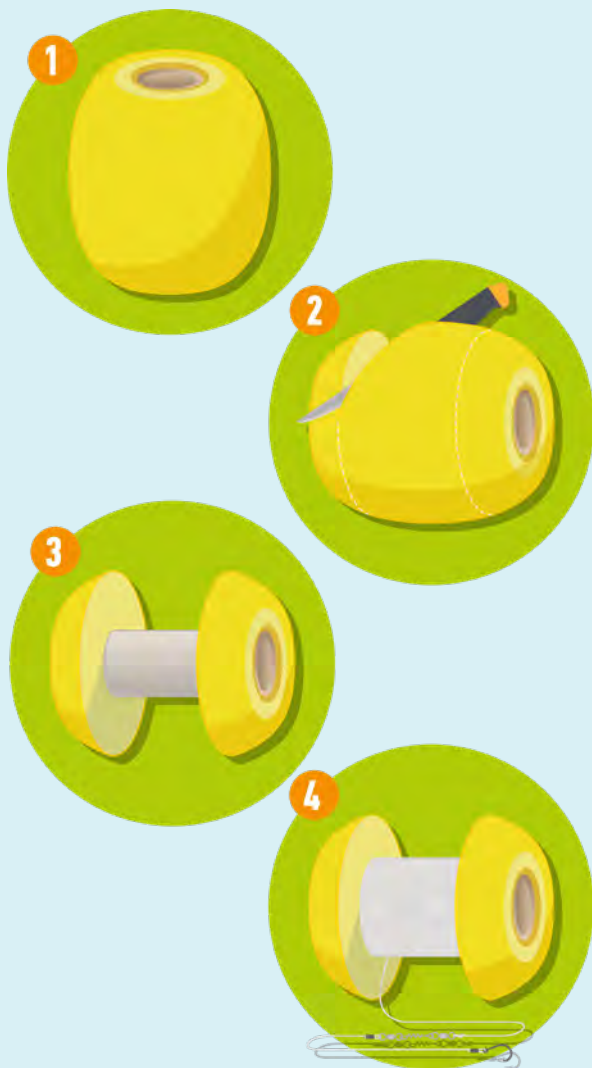

How to make a soft float drifting line.

Self-righting float drifting line

How to assemble the gear is shown in the second illustration of [section 6.6](#). Remember to sand and roughen the smooth surface of the ABS float before painting it in two bright contrasting colours.

The way to block the chosen length of mainline hanging down from the handcaster is as follows.

1. Drill a hole about 5–7 mm in diameter through the groove of the handcaster and one at the margin of the flange.
2. Make a large loop with the backing cord secured by a double overhand knot and pass it through the groove hole from the outside to the inside of the handcaster.
3. The loop will be passed over the winded mainline and through the second hole to block it. Remember to attach the mainline to the backing cord overhand knot before winding it on the handcaster.
4. The desired length of mainline is left out of the handcaster and blocked by the backing cord.

The gear can be used with a simple leader with baited hook, or a drop stone, palu-ahi or cone-bag rig.

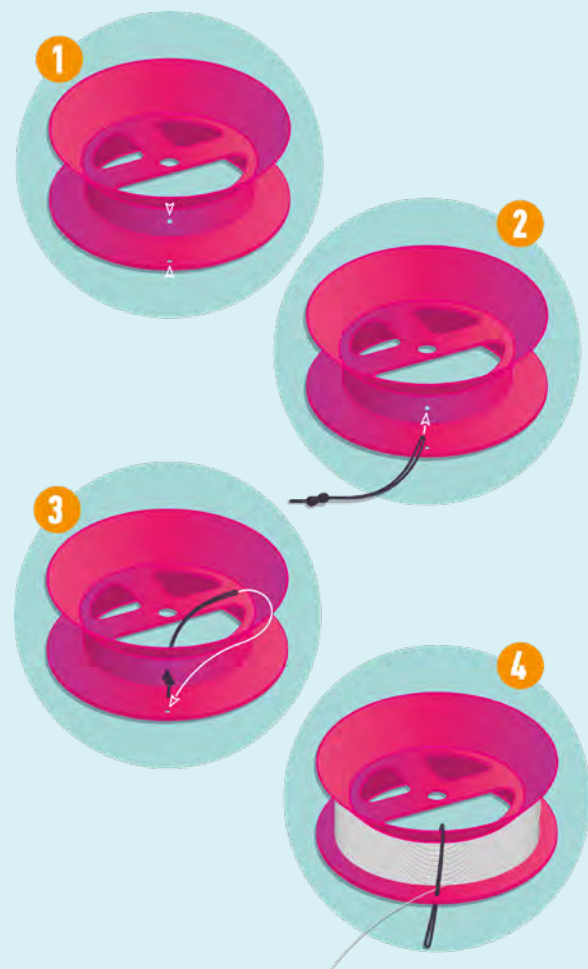

Using the gear

Simple foam float drifting line

The simple foam float drifting line is used to target mahi mahi and small tuna species. A baited hook or a drop-stone parcel is attached to the mainline snap swivel and dropped into the water. When using a drop-stone rig, the parcel needs to be jerked to release the hook, chum and stone before the foam float is left to drift. The 30-m mainline will then slowly unravel.

Drifting line with a self-righting float

Similar to the technique used for drop-stone, palu-ahi or cone-bag fishing (see [sections 6.2, 6.3 and 6.4](#)), pay out about 10 m of mainline, then drop the drop-stone, palu-ahi or cone-bag parcel over the side of the boat. Smoothly pay out more mainline until you reach the desired depth. Pass the large loop through the flange hole to lock the mainline, then connect the long line snap to this loop. Connect the quick-release clip to the braided cord. Then, jerk the mainline to unravel the parcel. Throw the float and hand caster into the water to drift. When a fish strikes, the tension on the line opens the quick-release clip and the bicolour ABS float turns upside down.



When a fish strikes, the clip releases the braided cord, and the orange side of the float turns upwards, indicating a fish is hooked.

Drift line fishing tips

- When letting floatlines drift by a FAD, keep them at least 100 m away from the FAD to avoid your fishing gear entangling with the FAD mooring line.
- When the first drift line has been set, allow it to drift a distance away from the boat to make sure it will not get tangled with the second line you set out.
- Avoid drifting too many float lines, as it can be difficult to keep track of where they all drift.



6.7 Chum canister fishing

This rig requires a weighted and perforated canister that contains and distributes the chum bait. The canister is lowered to the desired fishing depth and jiggled so that it releases the chum. Fishers use separate lines with baited hooks to fish at the depth that the canister is at.

Equipment and materials needed

Chum canisters (also called burley cages) can be bought but are unavailable in many locations. Where they are available, they can be quite expensive.

Making the gear

If you cannot buy a chum canister, you can make your own by following the steps below.

- Cut a 30 cm length of 80 mm diameter PVC pipe, and drill lots of holes through it so that the chum can escape.
- Seal one end of the pipe by gluing on a PVC pipe cap.
- On the other end, where the chum goes into the canister, screw on a threaded pipe cap, or wire on a plain cap.
- This cap should have a hole drilled through it so that a short strong monofilament or braided line with loops on both ends is attached. The outside loop is connected to the swivel and snap on the mainline.

It is a good idea to attach short lengths of rebar to the sides of your canister. These help the canister to sink and protect it from sharks biting and crushing it. If you do not have rebar, you will need to place a sinker in the canister to get it down into deep water.

Stiff galvanised wire or plastic mesh can also be made into a cylinder or cage and fixed in place with a tie wire. The best solution is whatever materials are available and your imagination!

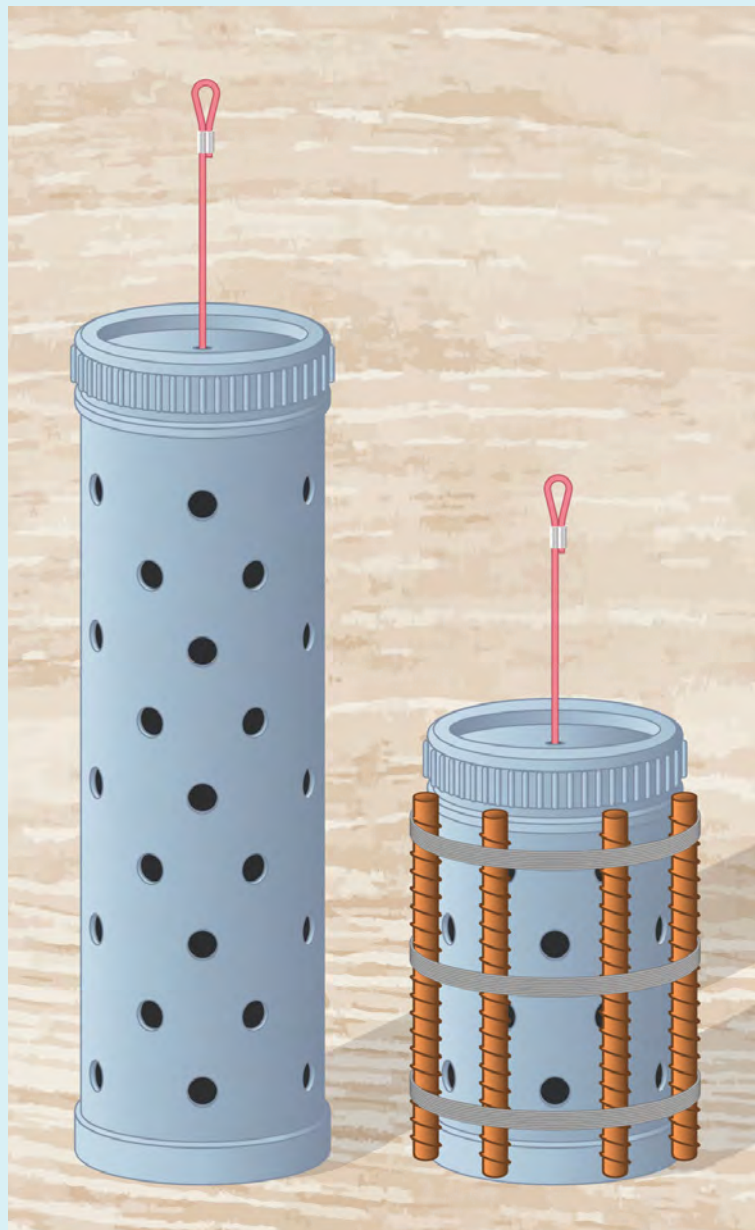

Home-made chum canisters.

Using the gear

When you begin fishing, tie or clip your chum canister onto a mainline, and lower it into the water at the same depth as your other fishing lines. Once it is there, it will disperse chum and help attract fish to your baited hooks.

The two main fishing methods used with chum canisters are mid-water line fishing with a baited hook and sinker, and spreader-rod jigging.

To use the chum canisters:

- *Mark the desired fishing depth on the canister line and fishing lines. The marks on the fishing lines should be about the same as those on the canister line so that chumming and fishing are done at the same depth.*
- *Chop the chum into small pieces that are slightly larger than the holes in the canister.*
- *Fill the canister about half full of the chum.*
- *Lower the canister to the desired depth from the bow of the boat, up current of your fishing lines.*
- *When the canister reaches the desired fishing depth, jiggle it continuously for a short while to allow the chum to break apart and disperse.*
- *Tie the canister line to the bow of the boat.*
- *Then lower the baited lines to the desired fishing depth and wait for the fish to strike!*

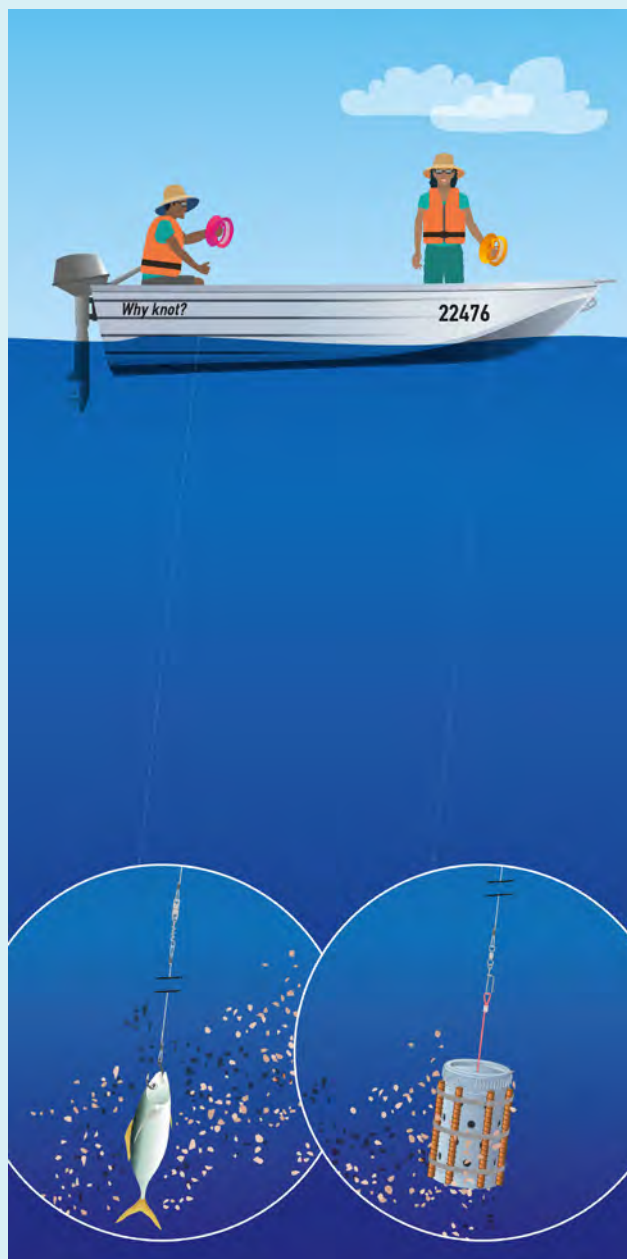

*Using a chum canister while mid-water line fishing.
The current brings the chum close to the baited fishing lines.*

Chum canister fishing tips

- This method works well with a sea anchor to hold the boat into the current. When the chum canister line is tied off at the bow of the boat where the sea anchor is attached, the chum will disperse around the baited hooks and attract fish.
- Chum canisters can attract large predatory species such as sharks, which may try to eat the canister. To avoid losing your canister, make sure you use strong line or even wire cable to suspend it from the boat.

6.8 Ika-shibi fishing

Ika-shibi is a Japanese term for “squid-tuna”. The fishery began in Hawaii in the 1900s when Okinawan immigrants started targeting tuna that often attacked the squid they were fishing for. Since then, the technique has been picked up in other Pacific Islands, and there is potential for the method to spread farther, especially where there are FADs.

Ika-shibi fishing is done at night, using a sea anchor. Traditionally, the boat is equipped with underwater and above-water lights so that squid and baitfish are attracted to the boat where they can be caught and used immediately as bait. The baitfish around the boat attract tuna and other large fish.

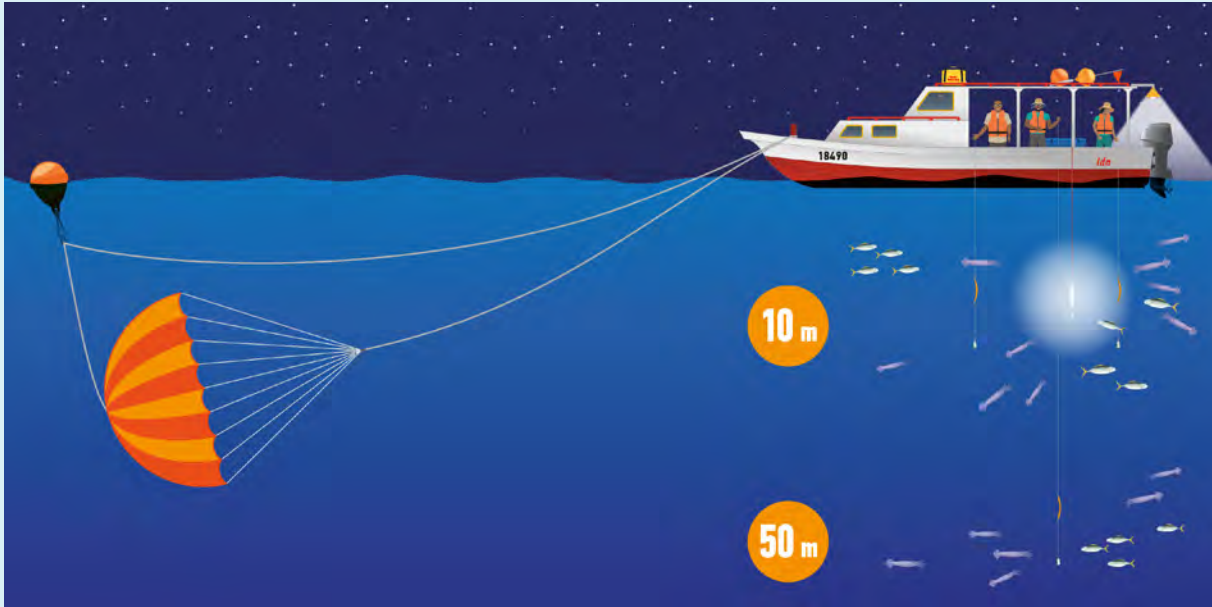

Ika-shibi fishing.

Most ika-shibi fishers also use large quantities of chopped-up bait to chum for fish. One night of ika-shibi fishing typically requires about 25 kg of chum.

Equipment and materials needed

The gear consists of a mainline and a leader, with a lead weight between the two, and a hook.

- **Mainline:** polypropylene rope 100–130 m long x 7–9 mm in diameter
- **Leader:** 7-strand stainless (200 kg test) wire, 0.5–2.0 m, or monofilament nylon of similar strength and length
- **Hook,** tuna circle size 14/0–16/0 or equivalent
- Some fishers attach a small float to the mainline at the surface to help set the hook and tire the fish

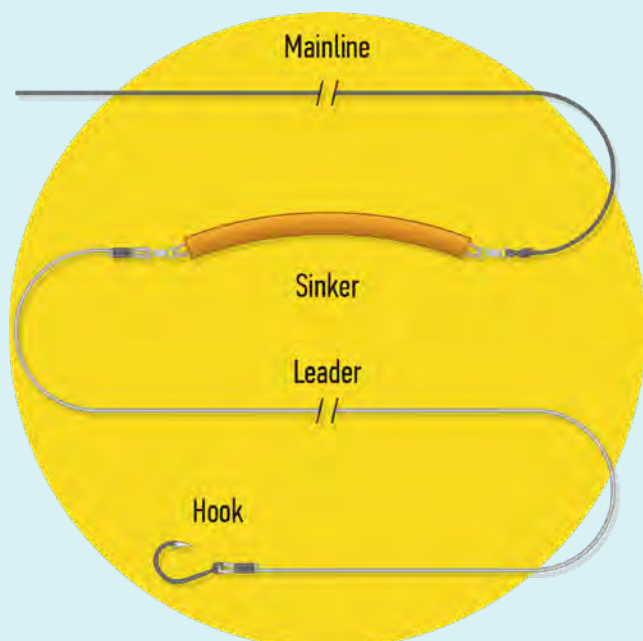

The sinker should be 250–500 g, and of a shape that will prevent it from rolling around on the deck and entangling the fishing line. It can be made of a lead-filled copper tube bent in the middle with a length of stainless-steel wire through it that is bent at both ends to form eyes to which swivels are fitted.

Traditionally, the gear was coiled and kept in a square box when not in use. Nowadays, many fishers prefer to use either commercial hand reels or home-made wooden ones.

Other equipment used by ika-shibi fishers includes:

- **Battery-powered 12-volt electric lights that are set both above-water and underwater to attract bait around the boat. Above-water lights are typically 200–300 lumens, while those below water are 200–600 lumens, waterproofed with silicon mastic.**
- **A parachute or sea anchor rig.**

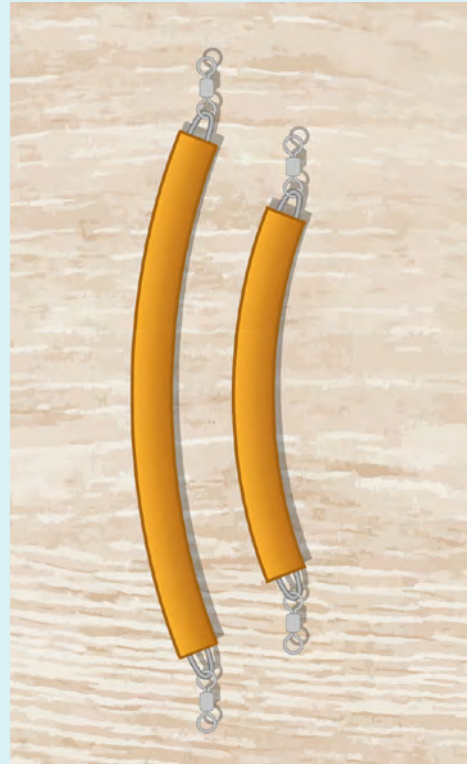

Home-made banana sinkers.

Using the gear

Arrive at your fishing ground at or before dusk. Deploy the sea anchor and ensure the ika-shibi lights are turned on. Depending on the boat's size, set out two to four well-separated baited hooks to begin fishing. Set the lines at different depths, ranging from 10 m to 50 m to spread fishing effort over the range where tunas are expected to be found. Once the first fish is caught, the lines are adjusted to target the depth where the fish seem to be biting.

The first lines are set using bait already on the boat. While waiting for the fish to strike, you can begin catching additional bait using the techniques described in [Chapter 8](#).

Chumming can also be done while your lines are fishing. Every 10–15 minutes, scatter a handful of chum in the water around the boat. The chum will slowly drift downward and down current to attract both tunas and baitfish to the boat.

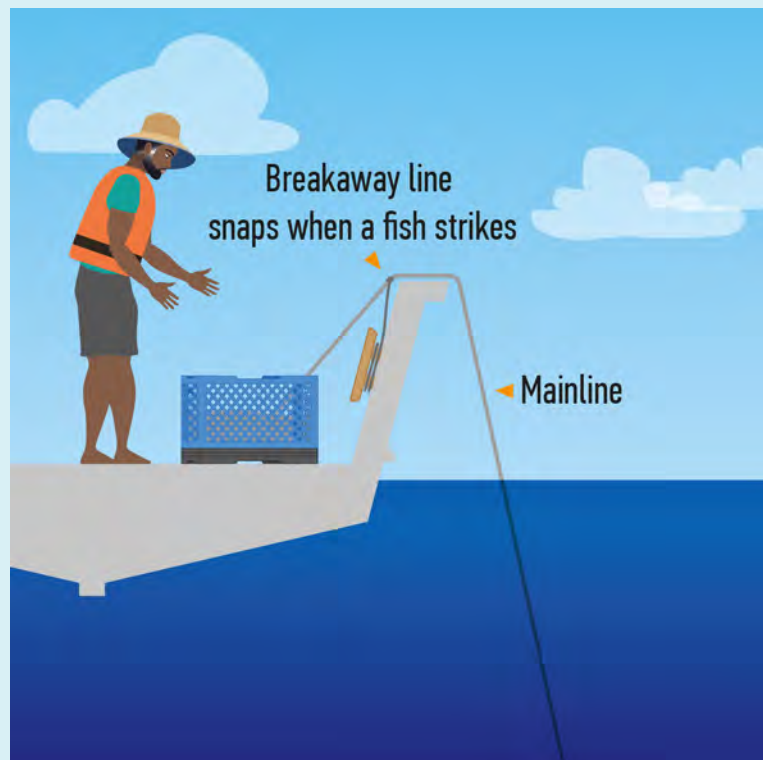

Using a breakaway line.

If you use a handline in a box, the mainline should be tied to a strong point on the boat with a breakaway line that will stop the line running out any farther and keep the hook at the desired depth. The breakaway line is intended to snap when a fish strikes, allowing the line to run out for a bit. But the breakaway line is fairly heavy – about 15–35 kg breaking strain – so it sets the hook when the fish strikes.

If you use a wooden hand reel, fit the reel with a brake made from elastic rope or an old inner tube, as shown in *Chapter 5*.

Using a float on the line, at the surface, will also help set the hook.

When a fish strikes, at least one of the other lines should be removed from the water as quickly as possible to reduce the chances of the lines tangling. Tuna strikes tend to happen simultaneously, and while it is possible to keep two lines with struggling fish from tangling, it is almost impossible to do so with three or four lines.

Ika-shibi fishing tips

- Be mindful of the way your boat drifts with wind and current, as land and reefs are hard to see at night.
- Fishing is best at around midnight when the moon is rising or setting.

6.9 Vertical longlining

Vertical longlining is based on the same principles as mid-water line fishing (see [section 6.1](#)), except that it uses a weighted mainline rigged with several branchlines carrying baited hooks. This technique allows a small-boat fisher to simultaneously fish in a range of depths while also concentrating several hooks in a small area, such as over a seamount or close to a FAD. The line can be fished from a boat or set to drift supported by surface floats, so that several lines can be fished at once.

Equipment and materials needed

A basic vertical longline comprises a single, long weighted mainline suspended from the surface, and reaching a depth of 300 m or more. Connected to the mainline are a series of branchlines, and each one has a longline clip with swivel and a baited hook. The branchlines are attached to the mainline at intervals of 15–20 m.

Below is a list of materials you will need to make a single vertical longline with a 300 m mainline, 15 hooks, and branchlines spaced at 15–20 m intervals. The distance between the float and the first branchline “upper section” can be 20–90 m.

1. Two plastic longline floats, 30 cm in diameter
2. Bamboo or fibreglass pole, 3 m long
3. Floatline: Polypropylene rope, 6–8 mm in diameter or Kuralon™ longline rope, 5–10 m long
4. Mainline: Monofilament nylon, 200–300 kg test, or Kuralon™ longline rope, 300 m long
5. Swivels (14), McMahon heavy duty, size 10/0–12/0, or leaded swivels.
6. 15 branchlines: monofilament nylon, 70–115 kg test, 3–6 m long (breaking strain must be at least 50 kg less than the mainline.). Note: branchlines can be snapped to the McMahon swivels themselves, or to the mainline, just above the swivels.

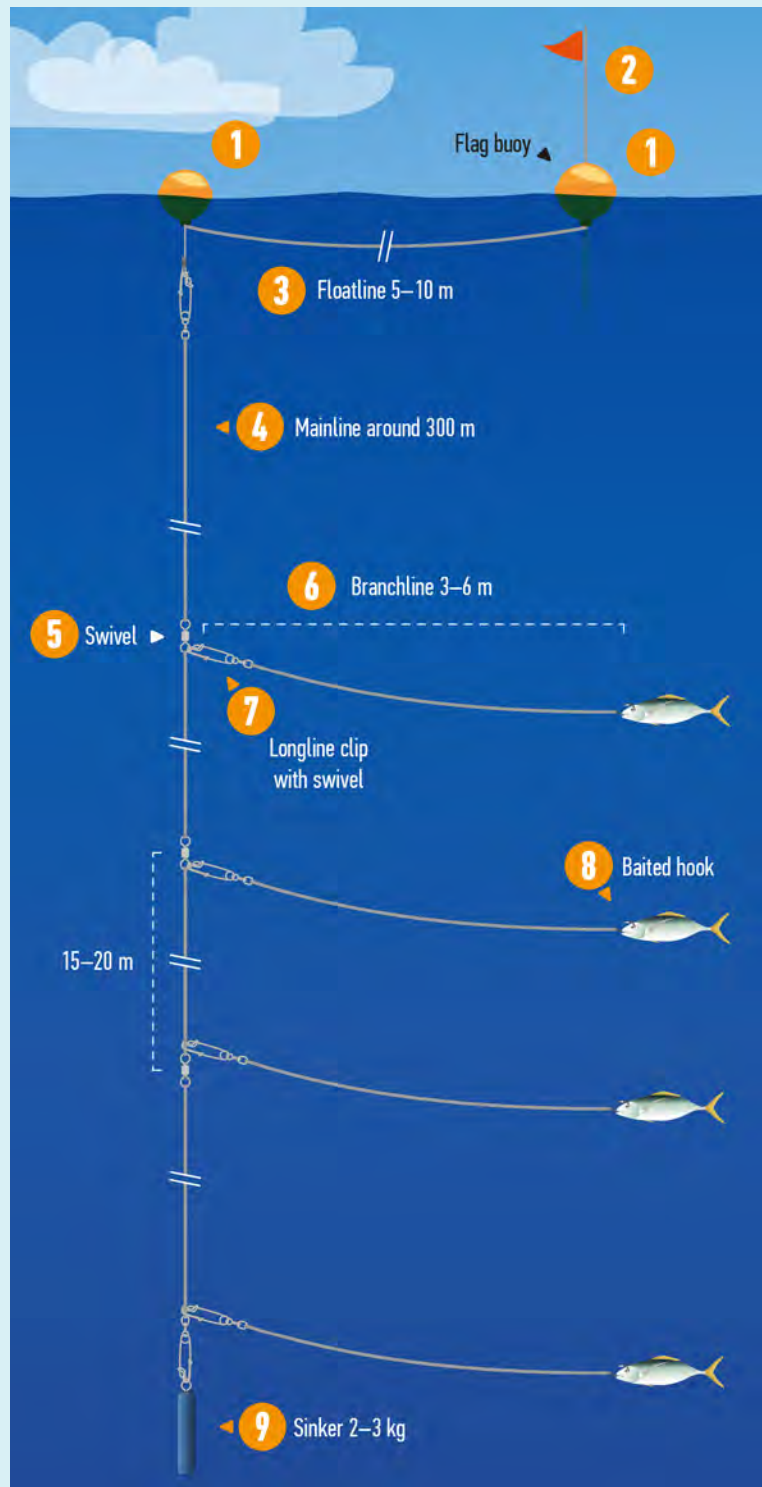

7. 15 longline clips with swivel, size 12 cm
8. 15 hooks: Mustad tuna circle size 14/0–16/0, or BKN size 48, or Japan tuna hook size 3.6 mm
9. Lead sinker, or lengths of rebar, 2.5 cm diameter by 25–40 cm long, tied or welded together to make weights of 2–3 kg

Making the gear

The diagram below shows the spacing of clips and swivels that might be used in a typical vertical longline.

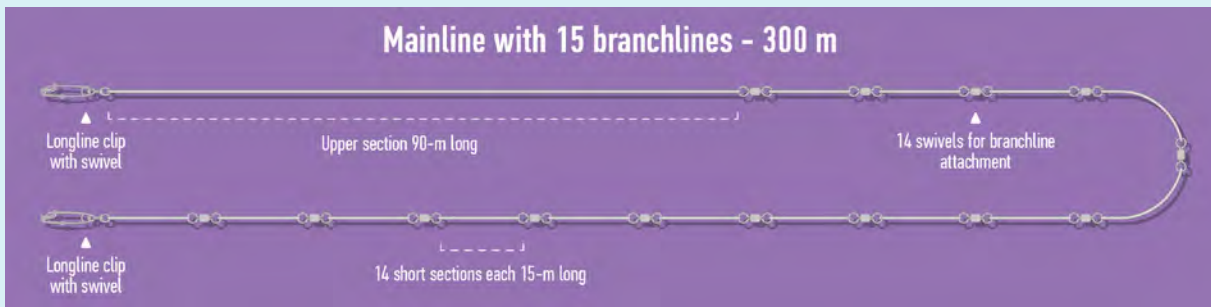

Some fishers incorporate swivels all the way along the line so that there is no upper section without swivels. This arrangement uses more swivels but has the advantage that the line can be used either way up, so that it does not matter which way the line is stored on a hand reel or laid out in a bin. This variation is particularly useful if you plan to set the lines float-first or if you plan to change your setting method between sinker-first or float-first, as described below. In addition, this variation allows the fisher to get more hooks in the water, and to target shallow-water fish species such as mahi mahi, sailfish and marlin, if these are present in the fishing area.

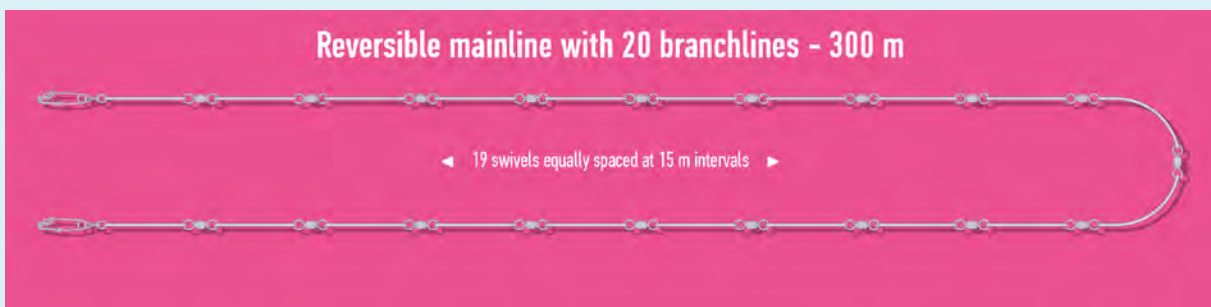

There are many ways to operate vertical longlines. The lines may be fished by hand from a basket or bin, or they can be wound onto a fishing reel. If using a basket, Kuralon™ or some other type of light rope is best because it is much easier to handle. But the more compact size of monofilament nylon line makes it a better choice for reels.

The wooden hand reel shown in [Chapter 2](#) can be used for vertical longlining if the mainline is made from monofilament nylon. If you use a hand reel, make sure it has a pulley or sheave big enough to allow the swivels to pass through when the line is being set and hauled.



A large open pulley is handy when setting a vertical longline from a wooden hand reel.

Setting the line

There are two options to set the line: sinker-first or float first. If setting float-first from a hand reel, a reversible vertical longline should be used so that it can be re-deployed without rearrangement.

If using the sinker-first method, lower the line slowly to:

- allow the person handling the bait to clip a branchline onto each swivel as the mainline passes by; and
- avoid tangling the branchlines with the mainline. The mainline should be lowered at the same rate that the bait sinks naturally.

Lowering the line slowly makes the sinker-first method time-consuming, with about 20–30 minutes needed to set each line.

Follow the steps below for a float-first setting, which makes it possible to deploy the mainline faster because the vessel's engine is used to accelerate the process.

- Attach a flag buoy and float at the end of the mainline.
- Lower the flag buoy and floatline over the side and begin slowly motoring away from the floatline.
- Continue to slowly motor in a straight line and pay the mainline out.
- When attaching the branchlines as the swivels go by, put the baited hooks overboard before connecting the longline clip to the mainline.
- Once the last branchline has been attached, clip the sinker and let it go over the side.

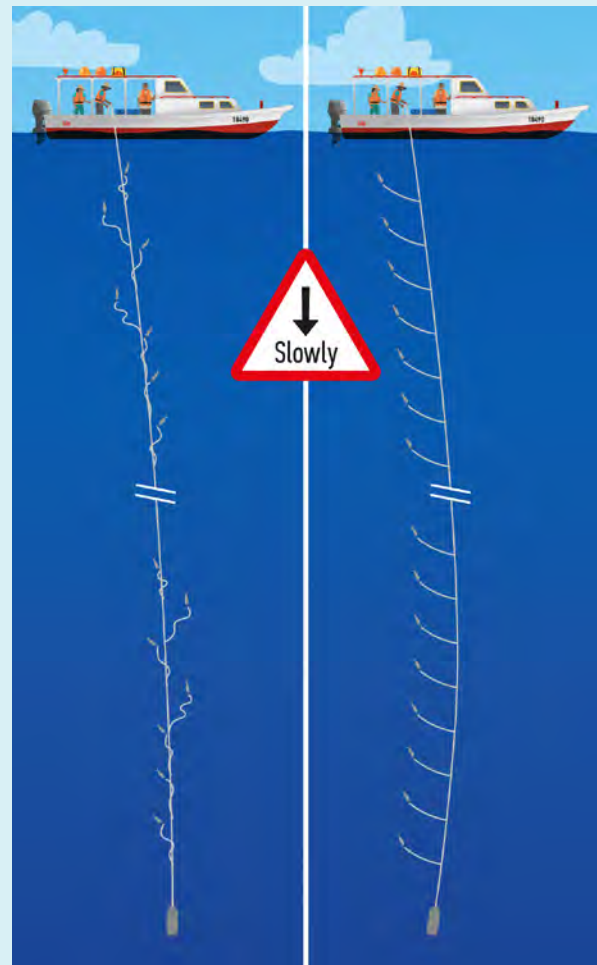

If the vertical longline is lowered too fast (left), branchlines will tend to wrap around the mainline.

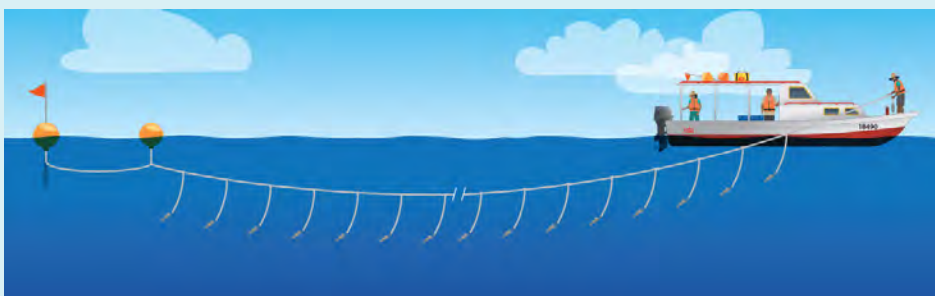

The method has two advantages: 1) the whole process takes less than 10 minutes, and 2) the branchlines always stay clear of the mainline on the descent.



Setting a vertical longline float-first.

Hauling in the line

Hauling begins after the lines have been in the water for 2-5 hours, or when fish have been hooked. Many times, the movement of the floats on the surface lets you know that you have one or several fish on the line.

If you use a hand reel, transfer the mainline clip from the floatline to the reel before winding it up.

If you fish from a basket, transfer the mainline clip from the floatline to a cleat on the boat before hauling it up.

In both cases, take great care not to lose the line during the transfer, especially if there is a fish on the line.

The hauling process then proceeds as follows.



If the vertical longline is hauled in too fast (left), branchlines will tend to wrap around the mainline.

- Just like with setting, hauling should not be done too quickly. If the line is pulled in too fast, the branchlines will tend to tangle with the mainline. The line should be hauled in patiently and with as steady a motion as possible.
- When the first swivel appears, the person handling the line should stop hauling so that the branchline can be checked.
- Care should be taken to ensure that the hook always remains in the water as long as the branchline is attached to the mainline. This way, if a fish that is lower down on the line makes a run, no one in the boat will get hurt by a flailing hook.
- If there is a fish on the hook, the branchline is left connected to the mainline while the fish is gaffed, stunned, and landed onboard. Only then is it safe to unclip the branchline from the mainline and put it away.
- If you plan to reset the line and if the bait is still in good condition, put the branchlines aside with the bait still on the hook. Otherwise, remove the bait and place the branchlines on a hand caster or in a branchline bin.

Even if no fish appear to have been hooked, you should haul in the lines every few hours so that they can be checked, and the bait refreshed.

Setting multiple lines

Once you become familiar with vertical longline fishing, you may want to increase the number of lines you set out.

The float-first setting method makes it possible to set up to five lines per hour. This is probably the most that you would want to set because many lines in the water require constant checking and, hopefully, hauling in some fish.

When the first mainline has been set, allow it to drift a distance away from the boat to make sure it will not get tangled with the second line you set out.

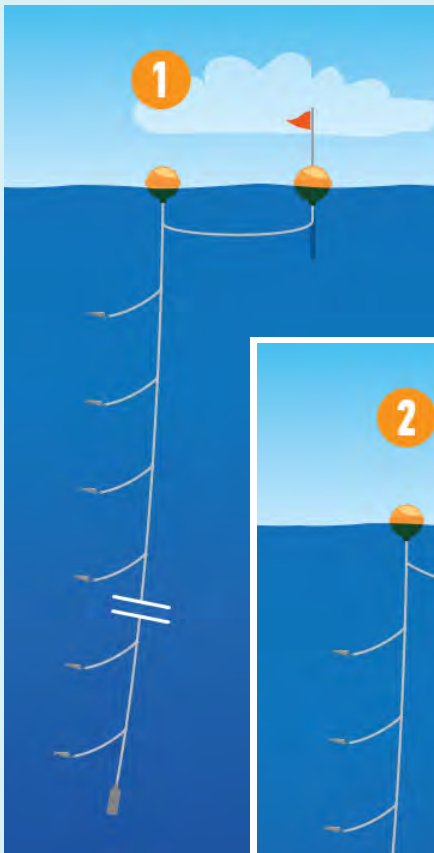

- Longline 1 is let to fish at a distance,
- while longline 2 is buoyed off close by, attached to the boat by a tether line, and
- longline 3 is directly attached to the boat.

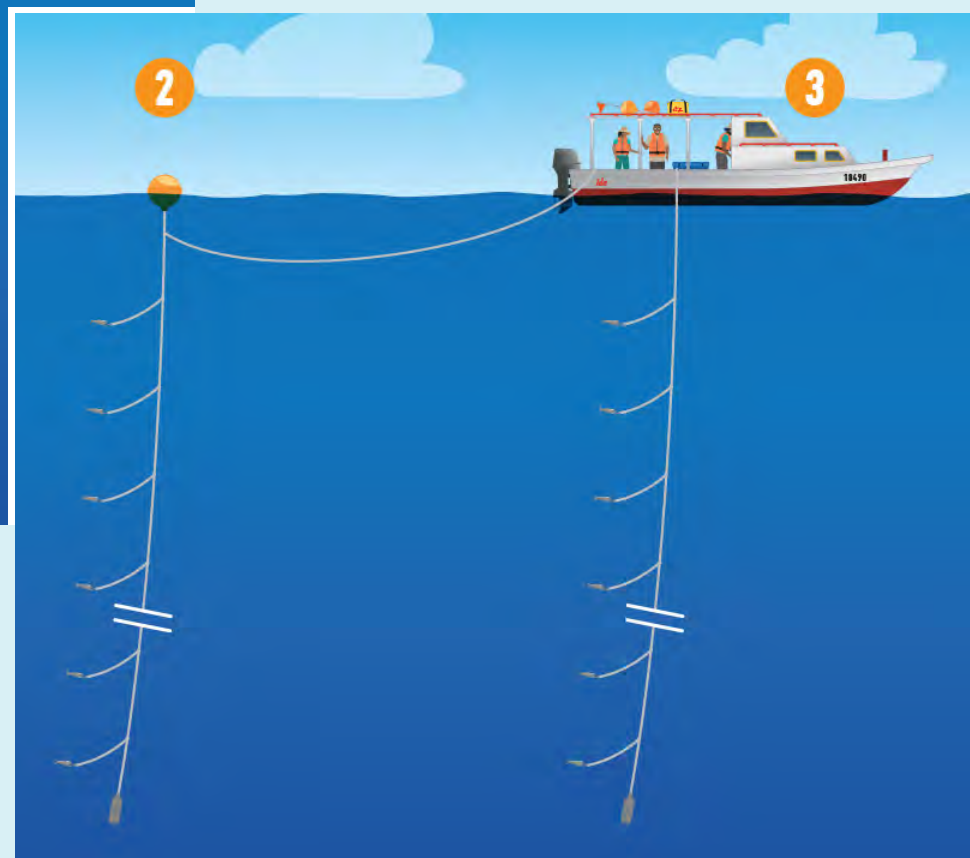

An alternative to allowing the lines to drift individually is to connect them together in strings, preventing them from separating too far apart and making them easier

to keep an eye on. It may be necessary to use longer floatlines (at least 60-m long) to keep the mainlines well separated, so they do not get tangled with each other.

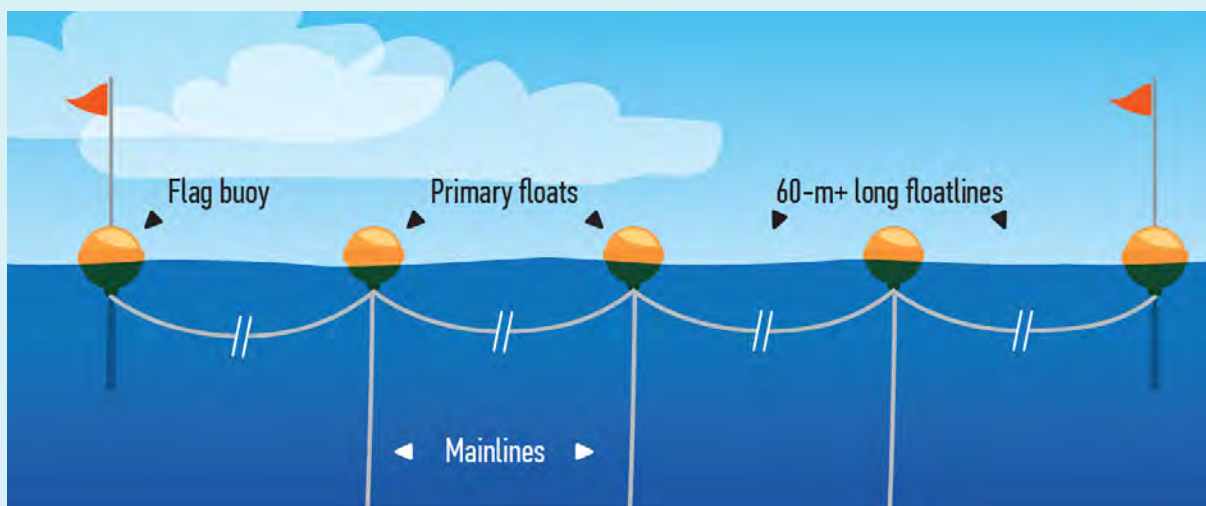

A string of three mainlines is let to drift.

Vertical longline tips

- Make sure the branchline length is less than half the distance between swivels on the longline; that way, the branchlines will not be long enough to reach each other and become tangled.
- Count the branchlines as they come up and keep a record of which ones caught fish. You will soon start to see the distribution of the catch by depth.
- Attach a flagpole buoy to each drifting longline, or string of longlines, to find it easily.

Scaling up

A natural progression from using multiple vertical longlines is to move to horizontal longlining. This is a larger-scale operation that requires more line, greater numbers of hooks and baits, and more sophisticated line hauling equipment. Horizontal longlining is not covered in depth in this manual. You can find more detail in SPC publication *Horizontal longline fishing: methods and techniques*.

6.10 Deep-water squid fishing

In the past decade, experimental fishing trials for diamondback squid have been carried out in a number of Pacific Island countries and territories. This squid lives in deep water and is typically caught in depths of 500 m or more. It can get very large, up to 100 cm in length and 30 kg in weight, although the average weight is around 20 kg (see [section 1.3](#)). Most commercial fishing for diamondback squid occurs in the Sea of Japan and adjacent areas.

Fishing for diamondback squid may also result in catches of the neon flying squid, which grows to a length of 70 cm and a weight of up to 18 kg (see [section 1.3](#)).

Although there are no commercial fisheries for these species in the Pacific Islands region, they have been found in several Pacific Island countries and territories.

Making the gear

Deep-water squid fishing is another form of vertical longlining, but it uses special squid lures instead of baited hooks. A list of materials required for one line is shown below, along with a diagram of the gear arrangement.

1. Main surface float, 20 litres, with 3-m-long flagpole and light indicator
2. Smaller intermediate floats (2 or 3)
3. Mainline, 450-m long, stainless steel cable 1.0–1.2 mm diameter, or braided line 1.0 mm diameter, or monofilament 2.0 mm diameter
4. Monofilament line, 25-m long x 2.0 mm in diameter
5. Speargun rubber, 5-m long x 12 mm in diameter
6. Trunkline (4 sections), monofilament, 5-m long x 1.8 mm in diameter
7. Swivel: barrel, rolling or crane swivel, size 9/0 up.
8. Longline snap with swivel, 10-cm long
9. Branchline, monofilament, 30-cm long, 1.8 mm in diameter
10. Blue LED underwater light
11. Bulb lures with 2.3 cm hooks
12. Sinker lure, 1.2 kg (20 cm), with 2.5 cm hooks

Note: Monofilament used for 4, 6 and 9 is usually red because red is the first colour to disappear with depth.

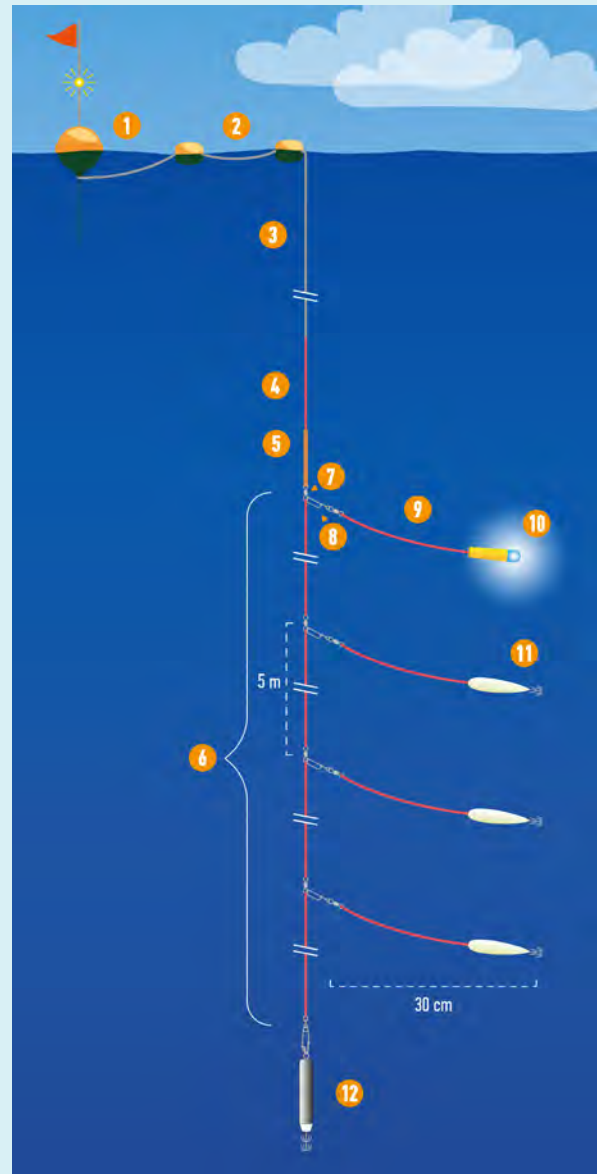

Using the gear

In squid fishing, multiple lines are set out, buoyed, and left to drift for several hours. Lines are generally set several miles offshore in depths of 500–2000 m or more. Setting the gear is always done sinker first. Ideally, the lines should be set early in the morning (5:00) and hauled up in the early afternoon. Setting and hauling four or five lines may take several hours in total.

The fishing operation requires reels and is a lot easier and quicker if motorised reels are used.

7 Deep-bottom fishing

Deep-bottom fishing involves setting out one or more fishing lines in depths of 100 m or more. This method catches predatory fish that feed on bottom-living fish and crustaceans (including lobsters and crabs). Some of the fish species caught by deep-bottom fishing are shown in [section 1.3](#).

In the Pacific, deep-bottom fishing is mostly done in areas outside of barrier reefs and on seamounts, at depths ranging from about 100 m up to 400 m.

Because fishing grounds are outside of the lagoon, deep-bottom fishing is always carried out from a boat. This can be anything from a canoe to a large commercial fishing vessel, but in most cases artisanal fishing boats that are 6–12 m in length are used,

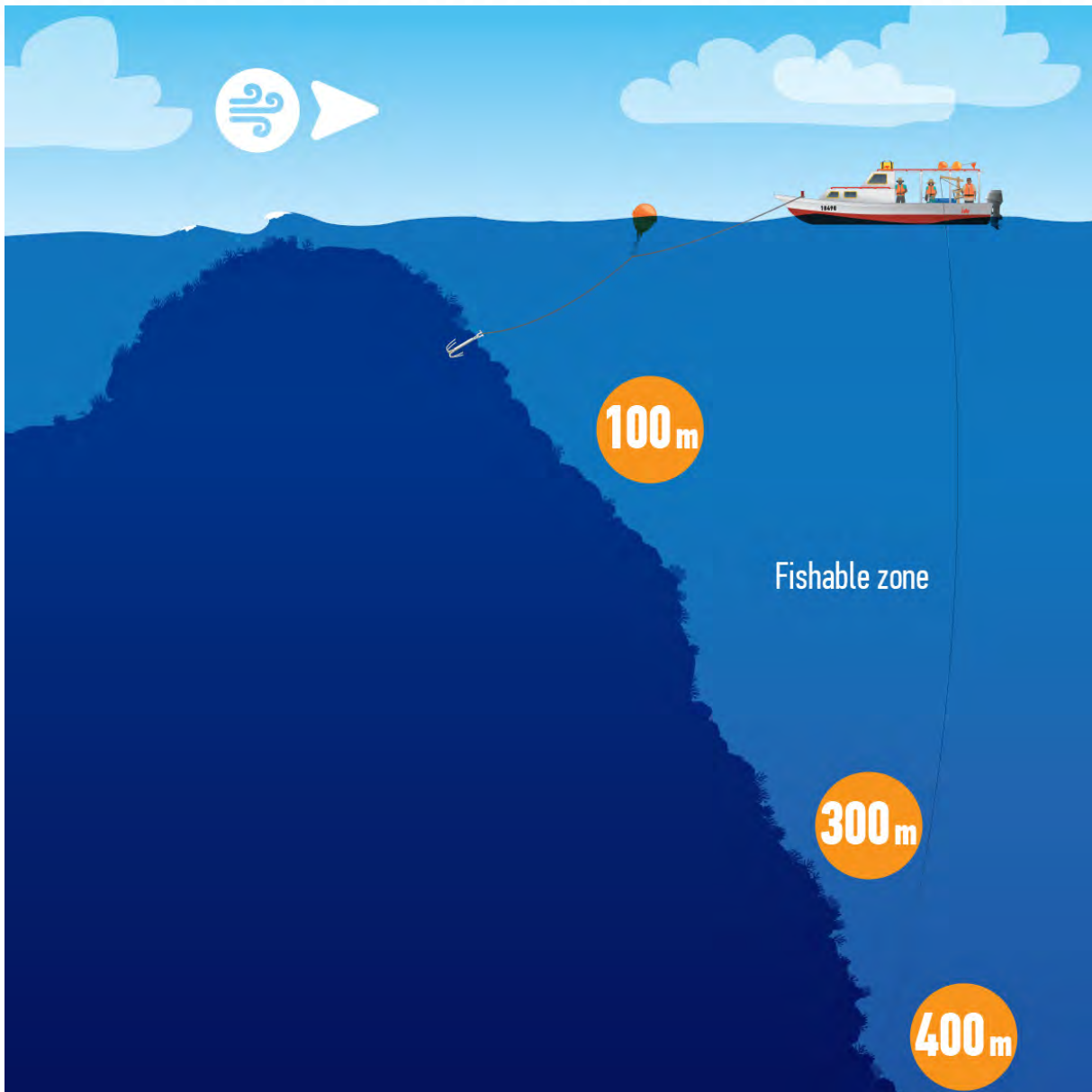

In the Pacific, deep-bottom fishing is done in depths of 100–400+ m.

7.1 Deep-bottom droplining

Equipment and material needed

Droplining is the most common type of deep-bottom fishing. The gear can be made from a range of materials, but the basic structure of the rig looks like this:

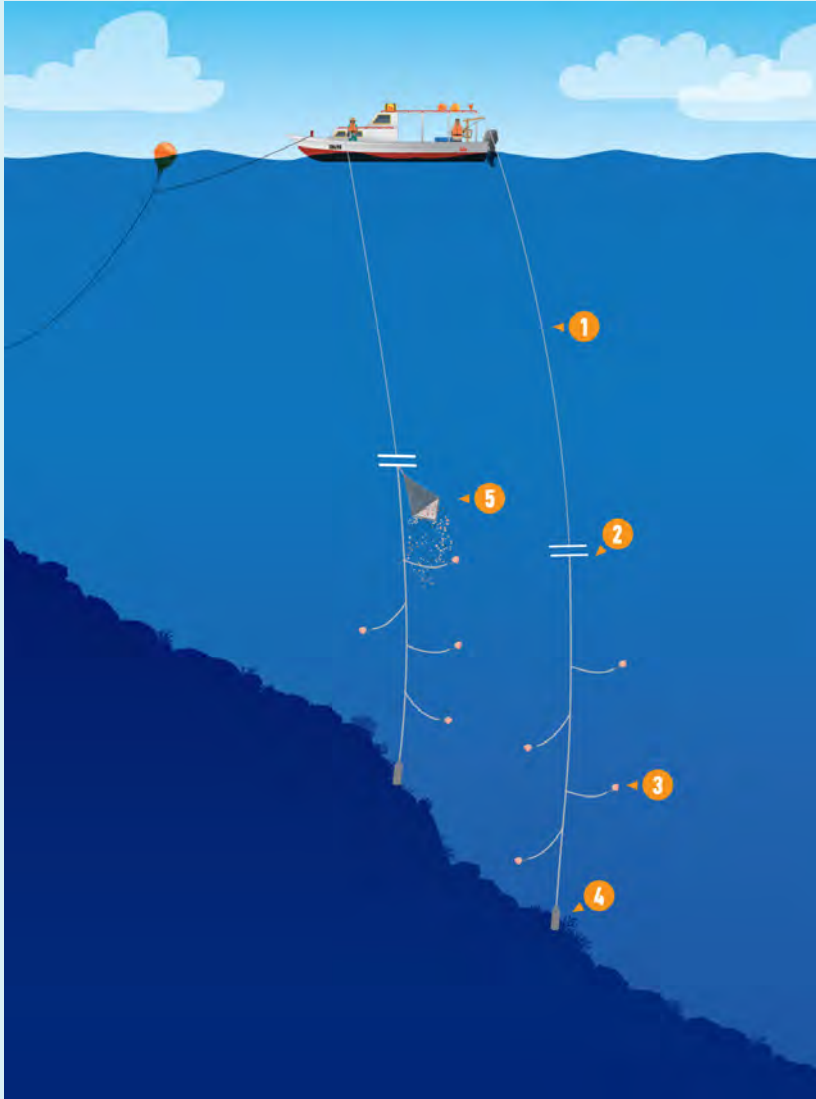

1. A mainline, several hundred metres long
2. A terminal rig – usually 1.5–2.5-m long, with attachment points for the mainline, hooks and sinker.
3. Several hooks, each fixed to a short leader connected to the attachment points along the terminal rig
4. A sinker, 0.5–2.0 kg according to the strength of the current
5. A chum bag at the top of the terminal rig (optional)

Fishing can be done by hand or using a reel.

Echo sounder

An echo sounder is used to find a suitable fishing depth, gauge the steepness of the sea floor, and to check whether the vessel has drifted into water that is too shallow or too deep.

An echo sounder comprises two parts: 1) the display screen, which is generally mounted inside the cabin or other sheltered location on the boat; and 2) the transducer, which points downwards to the sea floor.

The transducer is normally mounted through the hull, but some fishers prefer to attach it to a pole fixed to the vessel's transom or gunwale, so they do not have to drill a hole through the hull.

Transducers work by emitting bursts of low-frequency sound, that travels over the depth of the water column. The sound is reflected from any surface it encounters – sea bottom, fish, plankton, suspended particles in the water, and even temperature gradients in water. The sound signals then bounce back to the transducer,

which transmits this information to the display unit. By computing the time between the transmission of the sound and the bounce-back, the echo sounder measures the distance to the source of the reflection and posts this information on the display unit.

Most depth-sounders run on 12-volt direct current and require one or two deep cycle batteries onboard. Recent advances in technology have led to the development of small portable echo sounders.

Anchor gear

Deep-bottom fishing is typically done while at anchor. The gear needed to anchor in deep waters is detailed in [section 2.3](#).

Sea anchors or parachute anchors (see [section 2.4](#)) can also be used for



deep-bottom fishing when the surface current is not too strong. They are also a very good safety feature because they slow down the drift of a broken-down boat while the crew waits for help.

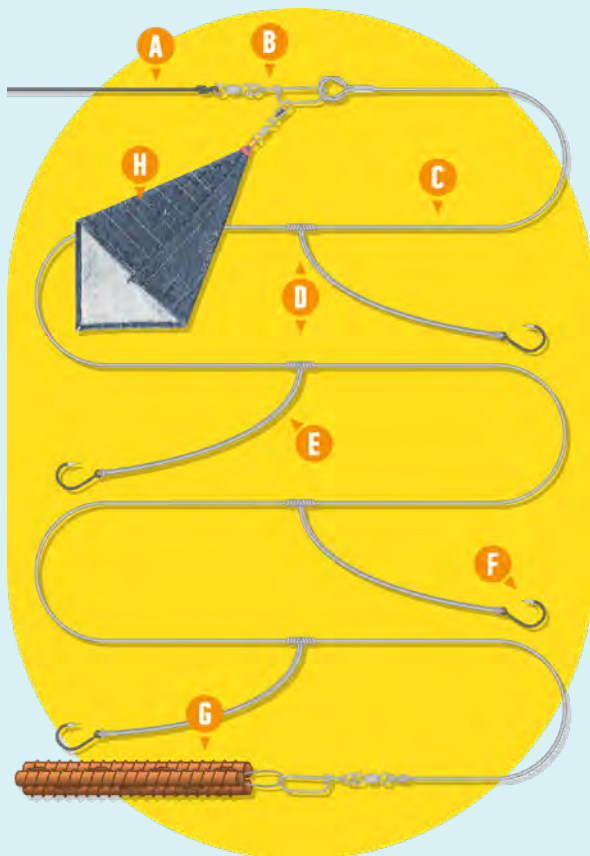

Making the gear

A dropline for deep-water fishing consists of two main parts: a mainline and a terminal rig.

1. **Mainline:**
 - A.** Monofilament, braided line or Super-Toto, at least 500-m long, 100–300 kg breaking strain
 - B.** Snap swivel
2. **Terminal rig:**
 - C.** Leader: monofilament, 1.5–2.5 m, breaking strain less than that of the mainline
 - D.** Attachment points. Can be made with dropper loops in the leader line (see [section 4.5](#)), or by adding 3-way swivels (see [section 3.2](#))
 - E.** Snood: monofilament, 0.3 m, breaking strain less than that of the leader line
 - F.** Hook: Mustad tuna circle 5–9/0, or equivalent
 - G.** Sinker, 0.5–2.0 kg
 - H.** Chum bag, clipped above the terminal rig (optional).

In the past, deep-bottom fishing was done using handlines, and some fishers still prefer doing it that way. But, using handlines for fish at depth has many disadvantages. Hauling in a handline from great depths takes a lot of time, and the length and thickness of the line make it impractical to flake it into a box or bin. Instead, the line is usually allowed to fall freely into the boat as it is being hauled in, but it can easily become tangled. In addition, large fish can be difficult to handle, and the rubbing of the line on the edge of the boat can cause damage to the line and the boat. For all these reasons, most fishers nowadays prefer to fish using reels.

Bait

Most fishers use skipjack or some other tuna as bait for deep-bottom fishing, but many other kinds of fish – or even squid – can be used. Tunas and other large fish should be filleted and cut into bait-sized pieces. Smaller fish can be cut into pieces or used “as is”. Any trimmings or waste pieces can be chopped up and used for chum.

The best hooks to use for deep-bottom fishing are tuna circle hooks, and the best way to bait them (or any other type of hook) is to hold the bait still and rotate the hook into and through it.

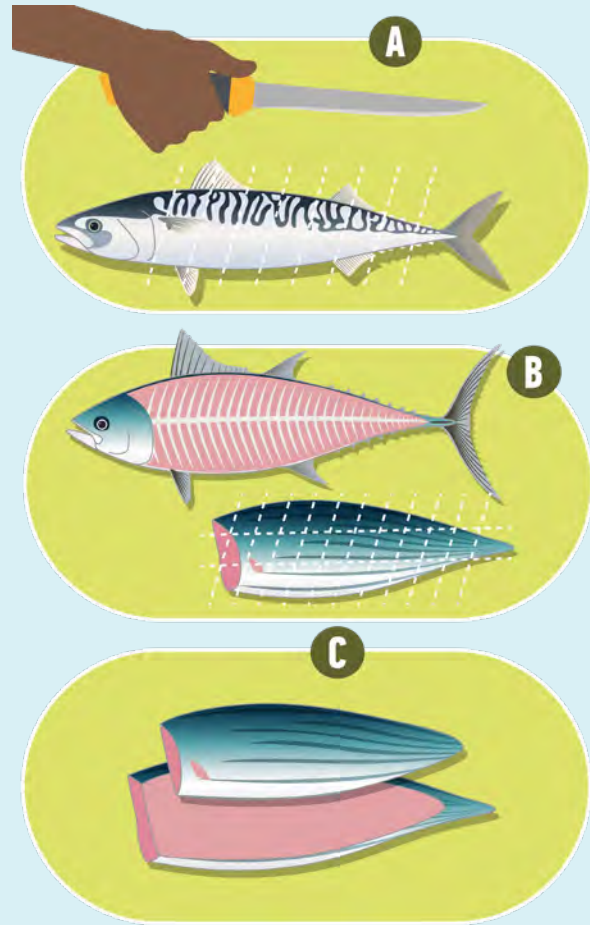

Bait size pieces are cut from whole fish (A) or fillets (B). If fillets are too thick, they can be sliced in two loins (C) that are then cut in bait-size pieces.



A hook is usually passed once or twice through the bait.

Bait can be hardened by salting as described in [Chapter 3](#). This is a good practice to follow if you use skipjack for bait because otherwise, it quickly becomes soft and mushy.

Chum

Using chum can help improve deep-bottom fishing catch rates. The smell of the chum excites and attracts fish to the baited hook.

To get chum down to the seafloor in deep water it is necessary to use a chum bag. It is made as follows.

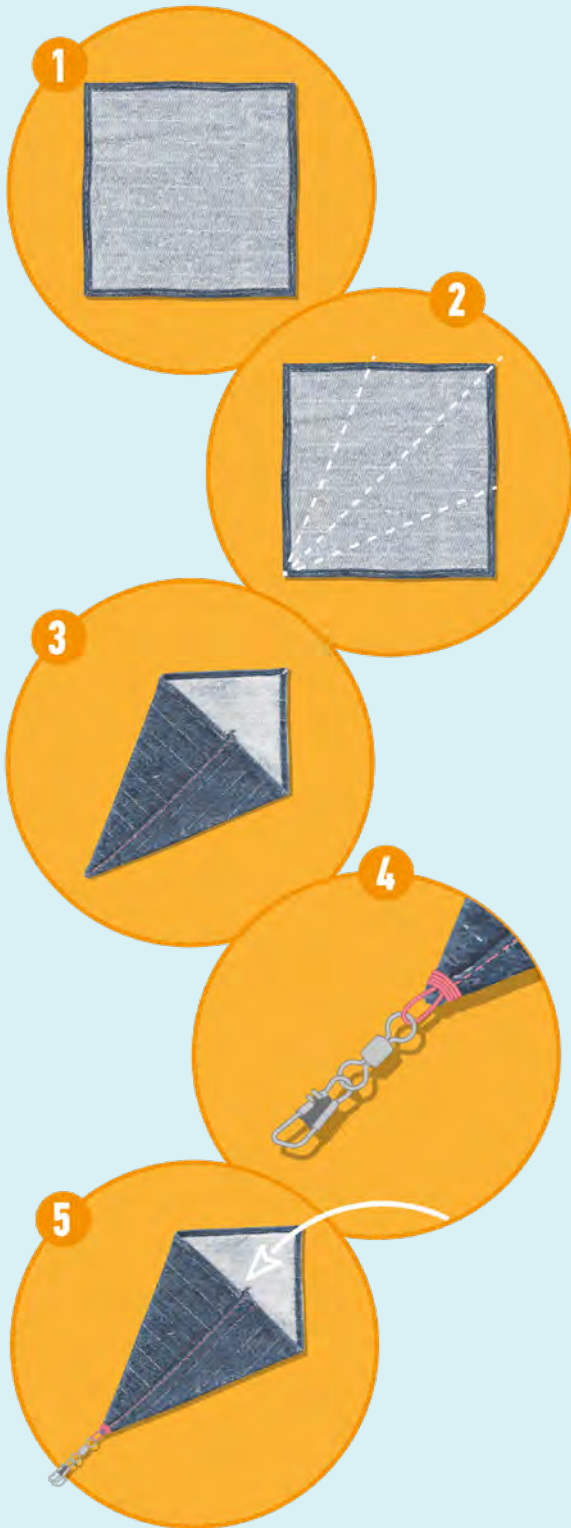

1. Cut a 25 cm x 25 cm square of denim, canvas or other heavy cloth.
2. Fold over two adjacent edges so that they meet in the middle.
3. Stitch them together.
4. Sew or tie on a snap swivel (or an eye made of strong cord) that can be used to connect the bag to one of the attachment loops on the terminal rig.
5. This gives a long cone-shaped bag with a flap at the end which can be tucked in after the bag has been filled with chum.

Many fishers prefer fixing the chum bag to the uppermost attachment point on the terminal rig. This is so that the chum will sink down on the hooks.

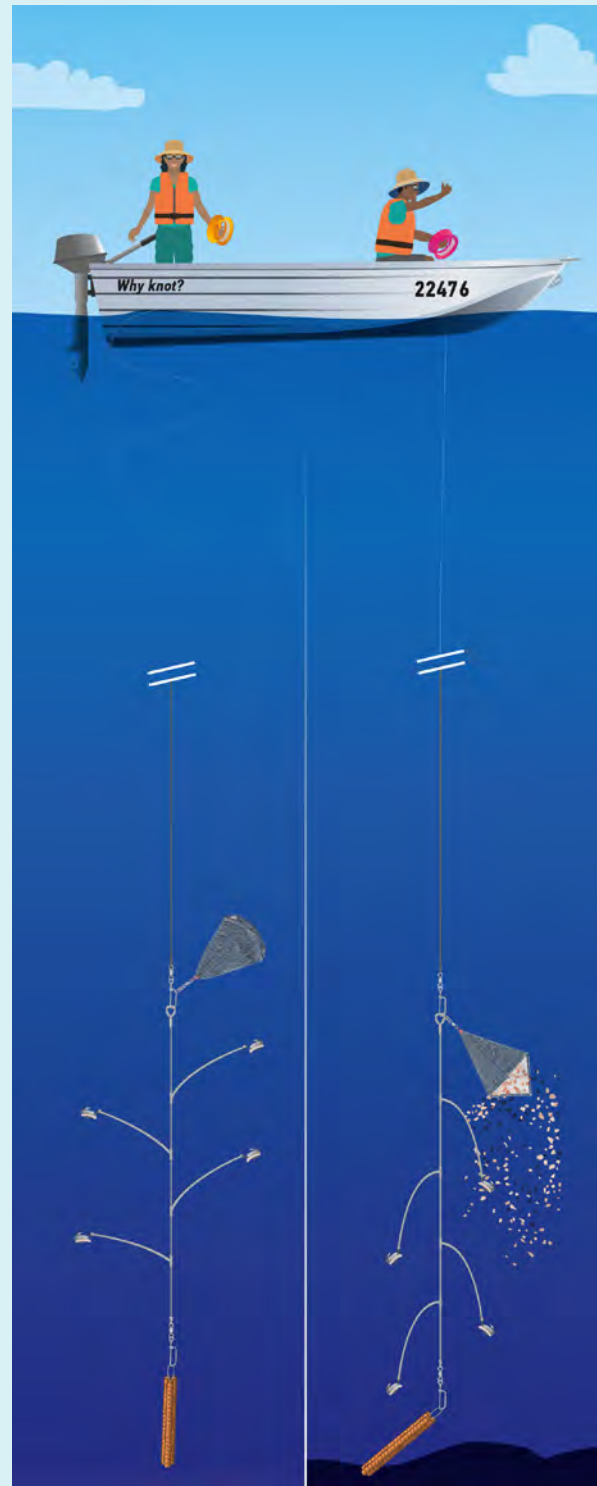

Using a chum bag to attract fish to the baited hooks.

Chumming is normally done while fishing at anchor, but it can also be effective when drift-fishing if there is little wind, and the boat drifts in the same direction as the chum.

Using the gear

Checking the depth

It is important to know the depth of the sea bottom before you anchor, and marine charts help with this. And, if you also have an echo sounder, then confirming the depth shown on the chart is simple.

If you do not have an echo sounder, depth can be measured by counting the number of times the hand reel turns before the sinker hits bottom. But to use this method, you must know how much line the reel takes up (or pays out) on each turn. You can easily measure this by unwrapping one turn and measuring the length with a tape measure. Most wooden hand reels take up between 1.0 m and 1.5 m per turn. To estimate the depth of the sea bottom, multiply the number of turns needed to touch bottom by the length of one turn.

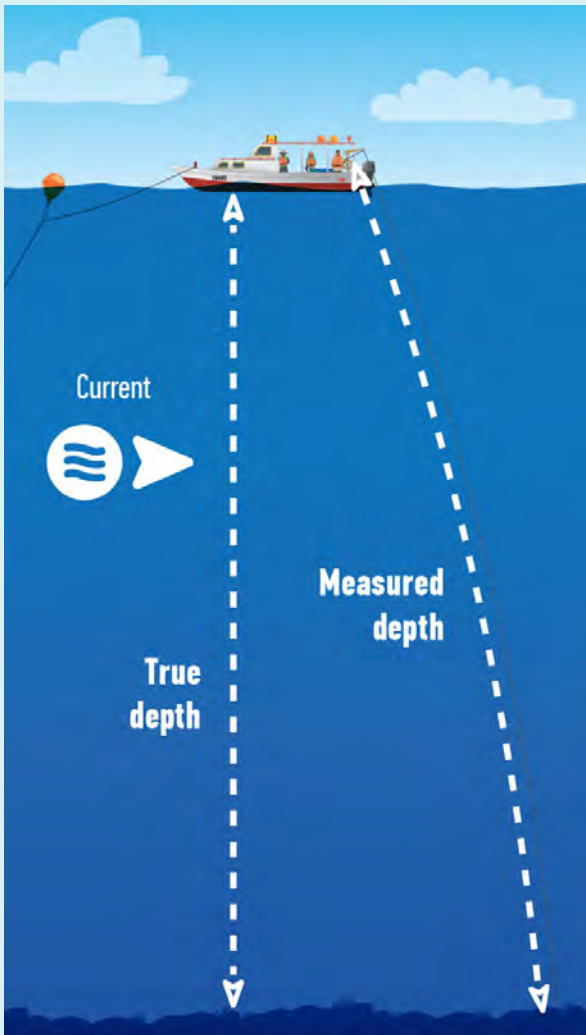

The depth measured with the fishing line is often greater than the true depth because the current takes the line farther away.

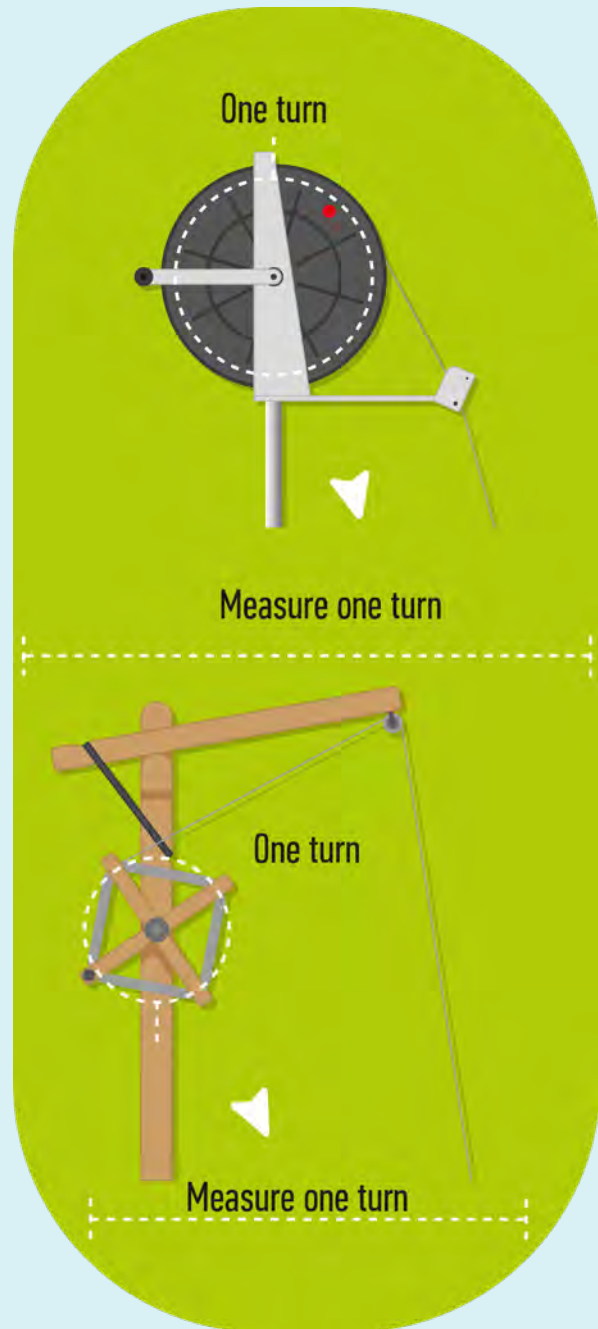

If one turn of line measures 1.5 m, and it takes 100 turns to reach the bottom, you are fishing at 150 m depth.

Whatever type of line you use to measure sea bottom depth, the current will act on it to pull it away from hanging vertically.

The true fishing depth can also be different from the depth measured by the depth sounder if you are fishing over a sea floor that has a lot of ups and downs.

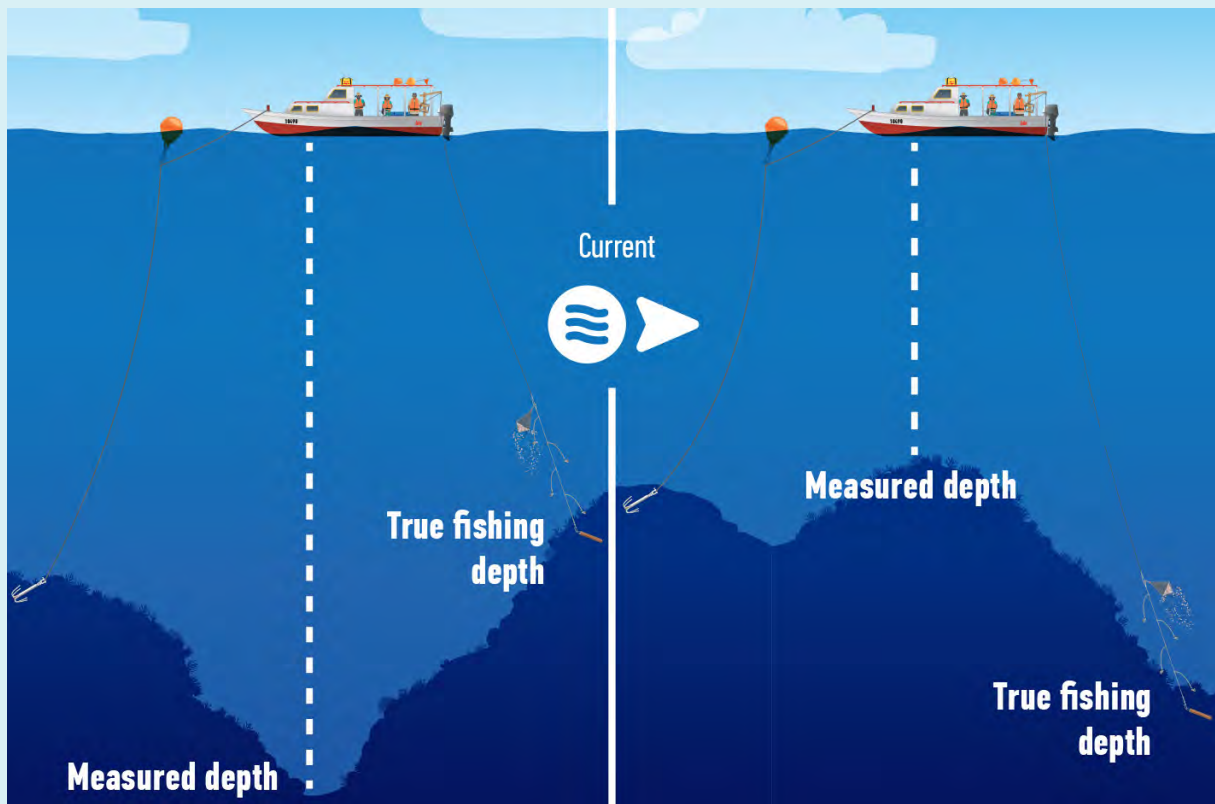

True fishing depth can be quite different from the depth measured by the depth sounder.

Anchoring

Except in calm weather, fishing on the lee side of a reef is much easier and safer than fishing on the windward side. Fishing on a leeward slope gives you

more control over your fishing depth and makes hauling in the anchor a lot easier.

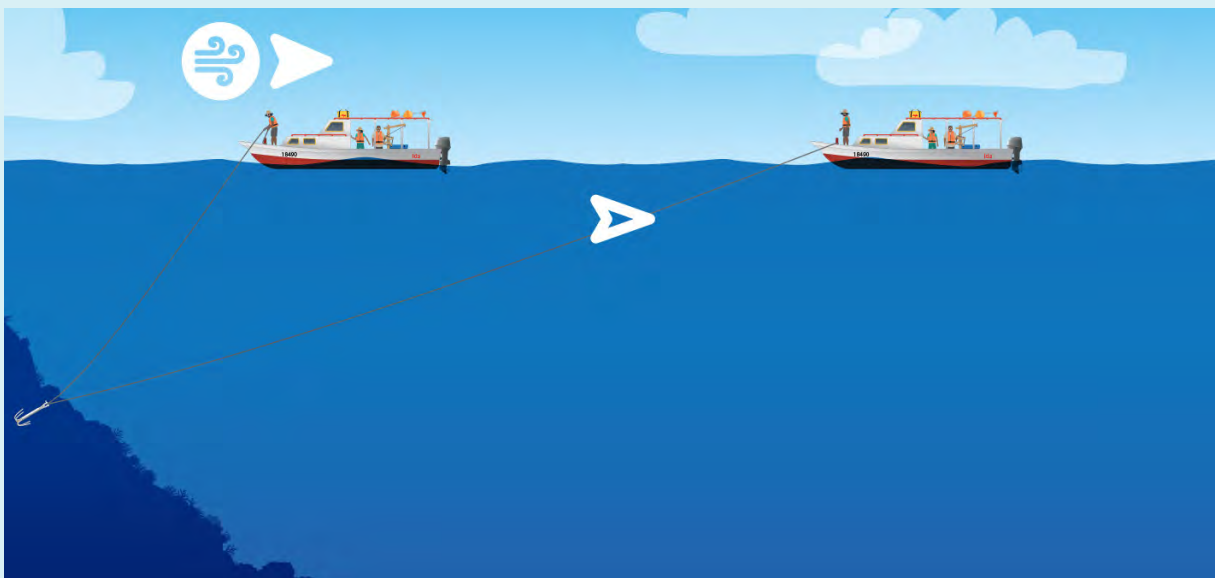

Fishing on the leeward side of a reef allows you to anchor in shallow water and fish deeper by adjusting the length of the anchor rope.

If there is little or no wind, or if the wind is not blowing from its usual direction, it is possible to fish areas that are normally windward of a reef. These areas often have steep slopes that make anchoring difficult, but fishing there is almost always worthwhile. Windward slopes are often more productive than leeward ones and are fished less often.

In general, when exploring a new fishing area, it pays to anchor in relatively shallow water and start fishing somewhere around 80 m depth. If the fishing there is not good, the anchor rope can be slacked off, allowing the boat to move to deeper water.

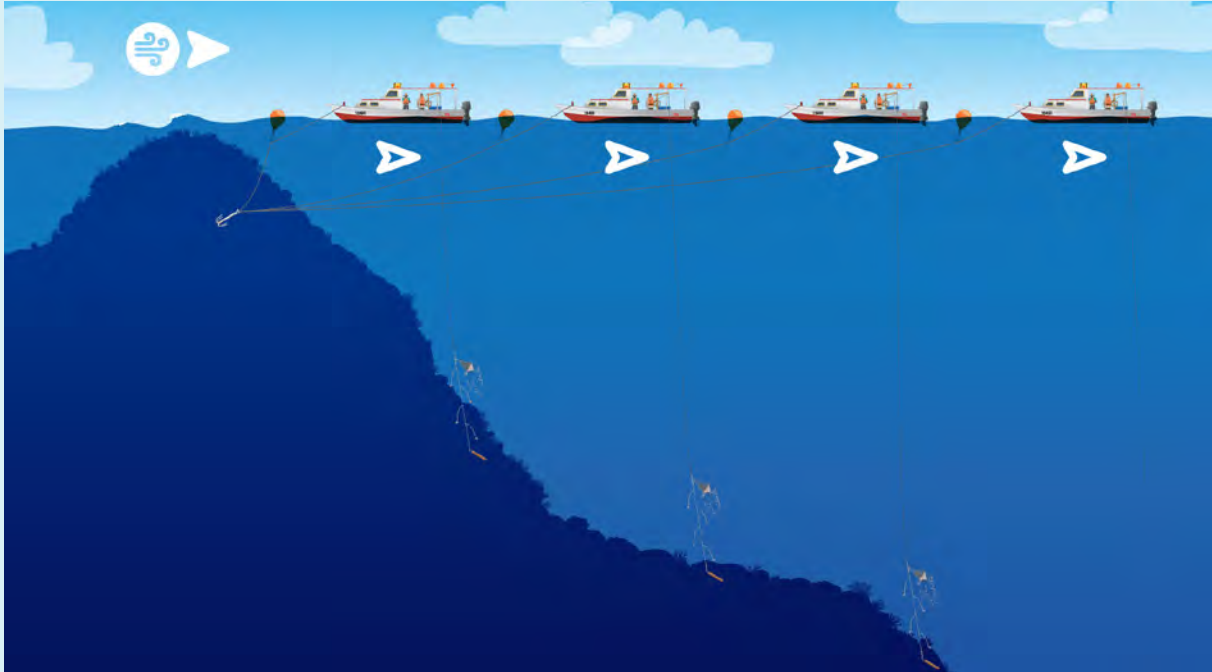

Slacking off the anchor rope makes it possible to fish at different depths.

The normal procedure for anchoring is to head into the wind and/or current and slightly past the place where you will drop the anchor. The anchor and chain are then lowered over the bow and let go. By the time the anchor hits bottom, the boat will have been pushed backwards by the wind over the anchor spot.

Catching fish!

At least one crew member should put their line in the water and count the number of hand reel turns it takes for the sinker to reach the seafloor, as described above, to evaluate the fishing depth.

Once the sinker hits the seabed, the line will go slack. If you keep paying out line, the terminal rig and slack line will lay on the bottom, and may get tangled on rocks and coral. Too much slack in the line will also make it hard to tell if the fish are biting. So, it is important to keep the line tight. In a big swell, this may mean repeatedly paying out and hauling in line as the boat rises and falls.

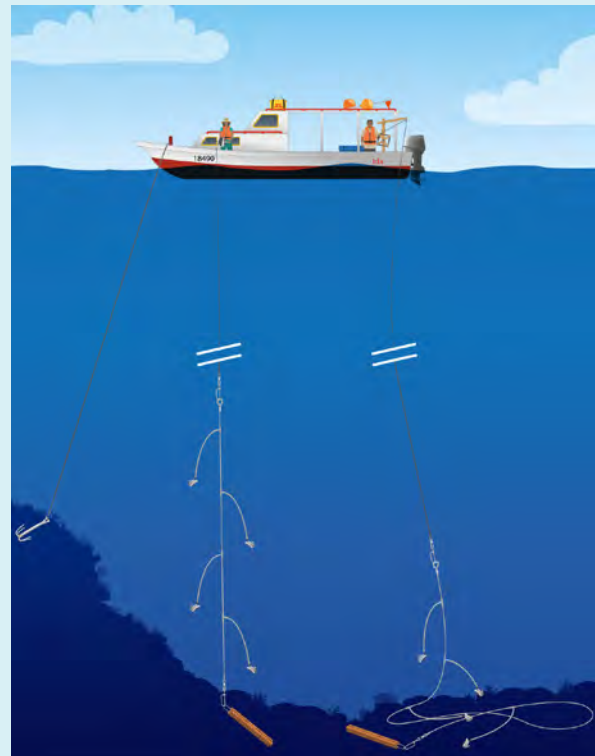

Fishing lines must be kept tight to prevent tangling with rocks and coral.

To keep the fishing lines well apart, use lighter sinkers for the lines down current.

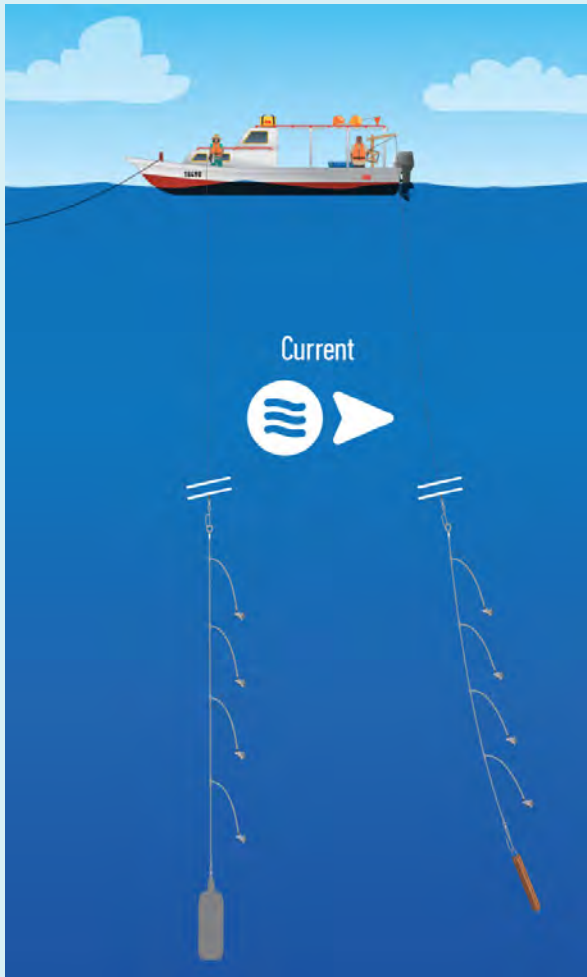

The current takes lines with light sinkers away from lines with heavy sinkers.

There is no mistaking the feel of a big fish striking your line. But feeling smaller bites in deep water can be difficult. If you fish with braided line, bites are easily felt. But monofilament nylon is stretchy and does not transmit the feel of a fish's bite to your fingers very clearly. The heavy fishing sinker tends to damp down the jerk of the line as the fish tugs at the bait, and if the sinker is dragging or bumping along the sea bottom, the bumps can be mistaken for bites. A strong current will make fish bites even harder to feel.

To help deal with these issues:

- **Always keep the line tight so that the sinker is just resting on the bottom, but the terminal rig is kept off the seabed.**
- **Make sure the line is not against the gunwale or side of the boat because this will prevent you from feeling the bites.**

- **Use a length of rebar or a lead sinker that is heavy enough that it will not bounce around on the seabed too much. If you use a length of chain as a sinker, the movement of the chain links may mask the jerks of a fish biting. Otherwise, feeling the bites of the smaller fish is a question of concentration, practice, and experience.**
- **When you do feel a bite, quickly haul in 5 m of mainline to make sure the fish doesn't have the time to shelter under a rock.**

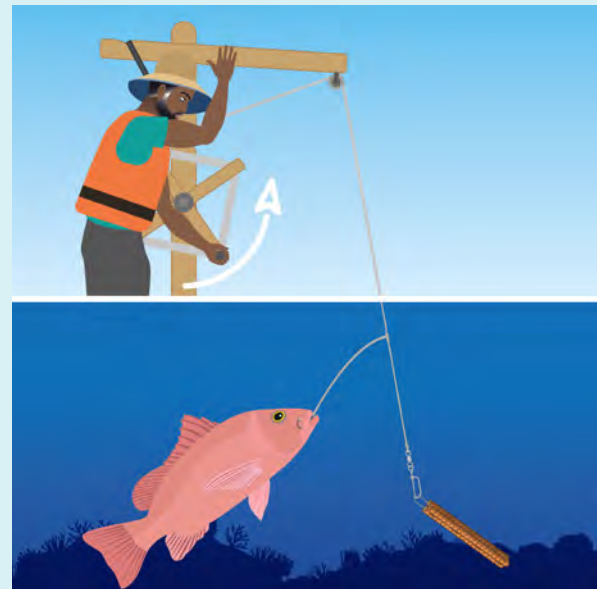

Quickly haul in 5 m of mainline when a fish bites.

Once the fish is on the line, haul it to the surface with an even motion. And do not stop hauling; otherwise, tension will be taken off the line and the fish can then escape. Fish caught in deep water usually inflate with air on the way up due to their swim bladder expanding. If you stop hauling, the fish will continue to float upward, and this can cause tangles in the line or allow the fish to come off the line. Once you have started hauling, make sure tension is always kept on the line, and do not stop until the fish is at the surface.

Although it is usually easy to tell if one or more fish are hooked on the line, it is not easy to tell if a small fish has been hooked or has taken the bait off the hooks. So, always check your hooks regularly – at least every 15 minutes – to see if you have a fish or whether you may have lost all your bait. Hauling in the fishing line should be done smoothly, and at a comfortable speed that you can maintain without stopping until the terminal rig is onboard. Handlines should be hauled in with a hand-over-hand motion, dropping the line on the deck in front of your feet. Hand reels should always be wound evenly.



Lifting a fish onboard by hand is simple but can be dangerous with sharp-toothed fish.

1. *If the fish is properly hooked, grasp the terminal rig above the first hook and lift the fish out of the water and into the fish bin or icebox.*
2. *If it looks like the fish could fall off the hook, grasp it by the gills and lift it onboard. Or,*
3. *Gaff it in the head.*

Once the fish is onboard, it should be placed straight into the icebox or a part of the boat where it can be controlled for unhooking.

Hauling up the anchor

After you are done fishing, or when you change fishing spots, you will need to haul up the anchor, sometimes from depths of several hundred metres. How to haul an anchor from great depths is explained in detail in [section 2.3](#).

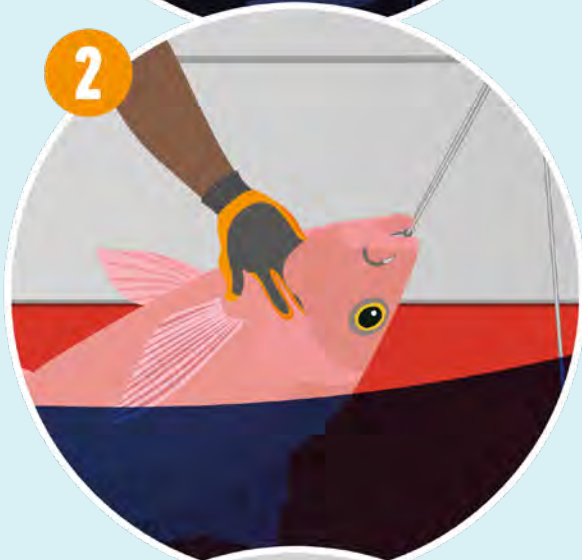

7.2 Deep-bottom longlining

Apart from the standard dropline fishing technique described in the previous pages, another method of capturing deep-bottom fish is by bottom longlining.

A basic bottom longline consists of a mainline that is tens or hundreds of metres long, and which has baited hooks attached to short leaders at regular intervals along its length. The ends of the longline are normally weighted or anchored, and at least one end has a retrieval line running to the surface.

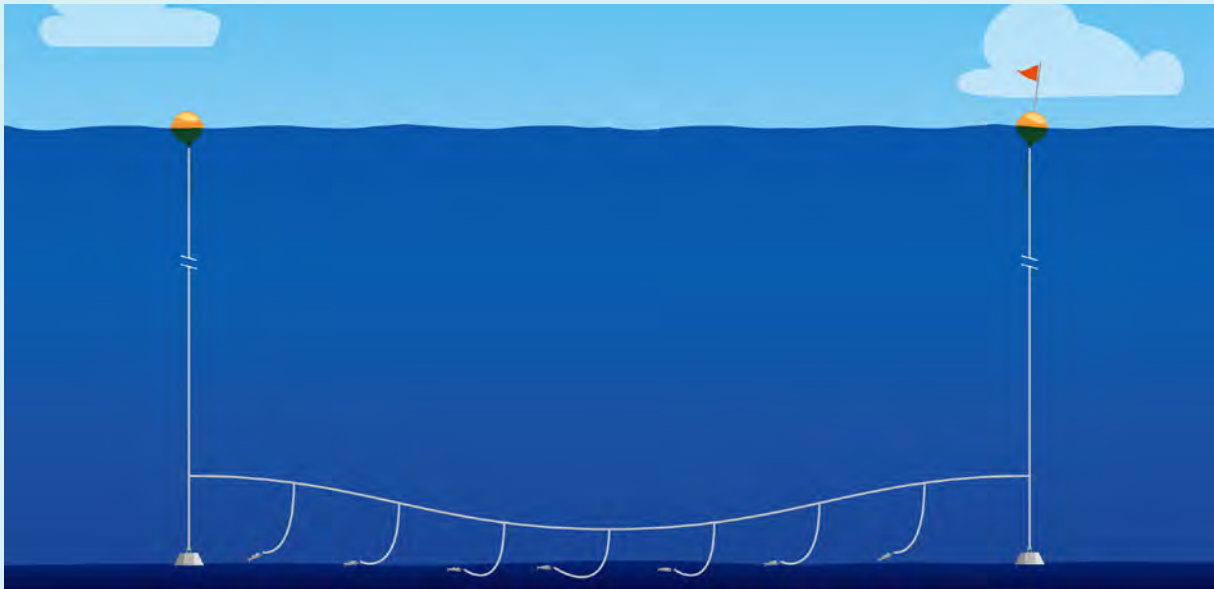

A basic bottom longline.

The line is usually set from a moving boat and then buoyed off until the time comes to haul it in. The float is set first, followed by the floatline, the anchor, the

mainline, another anchor, and then another floatline and float. The line can be hauled from either end, depending on weather and other fishing conditions.

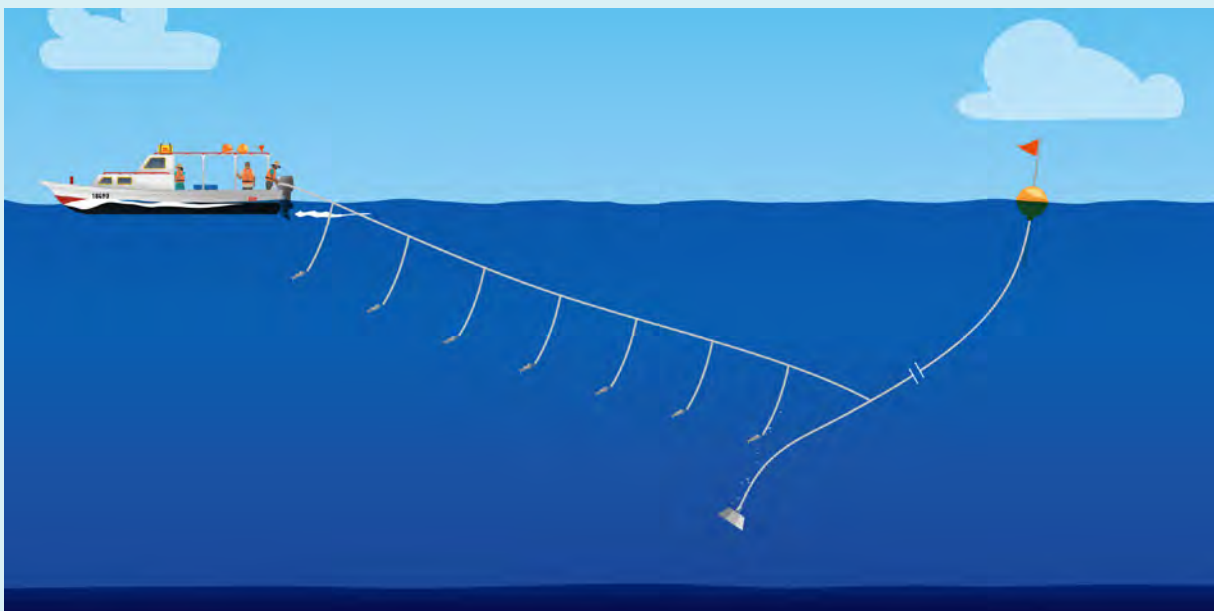

Setting a bottom longline.

In deep-bottom fishing, multiple hooks lying on the seafloor can become caught on rough or rocky ground, resulting in heavy gear loss. In addition, many

deep-bottom fish feed just above the sea floor and are reluctant to take bait that is lying on the bottom.

As a result, various methods are used to raise the baited hooks a little way above the sea floor. One way to do this is to attach pressure floats at various points along the mainline so that the entire mainline is lifted

off the bottom. The disadvantage with this is that the mainline, or parts of it, may be lifted too high above the seafloor.

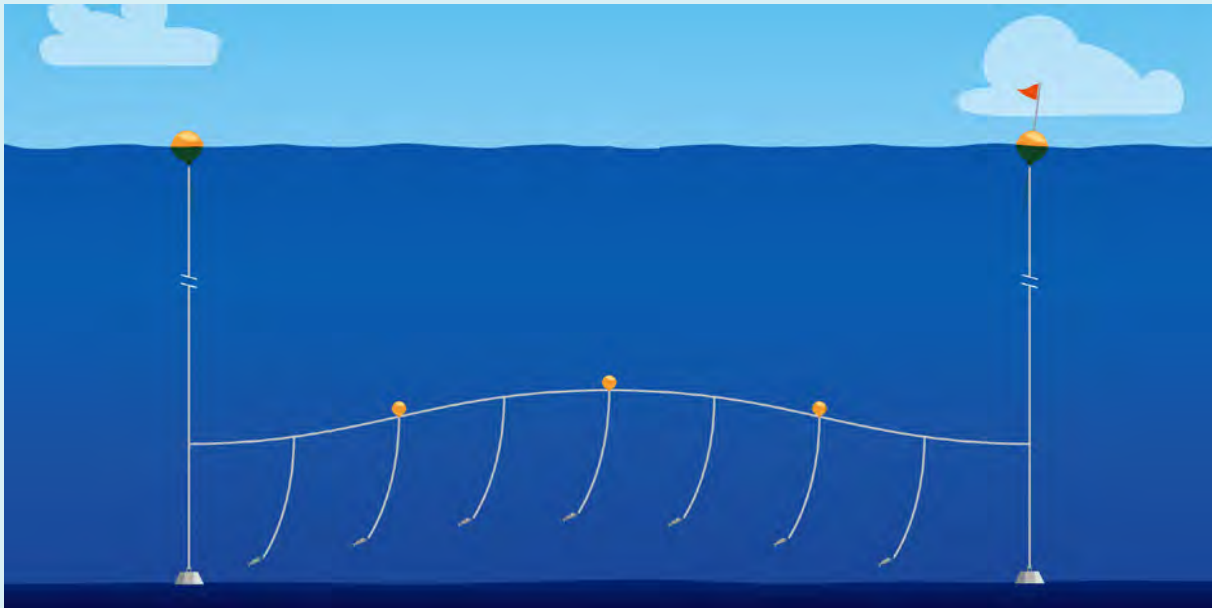

Pressure-resistant floats are used to lift the mainline off the seabed.

A better way is to replace the leaders along the mainline with droppers instead of simple leaders. A dropper is very much like a deep-bottom fishing terminal rig. It consists of a length of monofilament or cable with several attachment points for leaders,

a sinker at one end, and a small pressure-resistant float at the other end. When the longline is set, each dropper stands vertically above the sea floor as in dropline fishing.

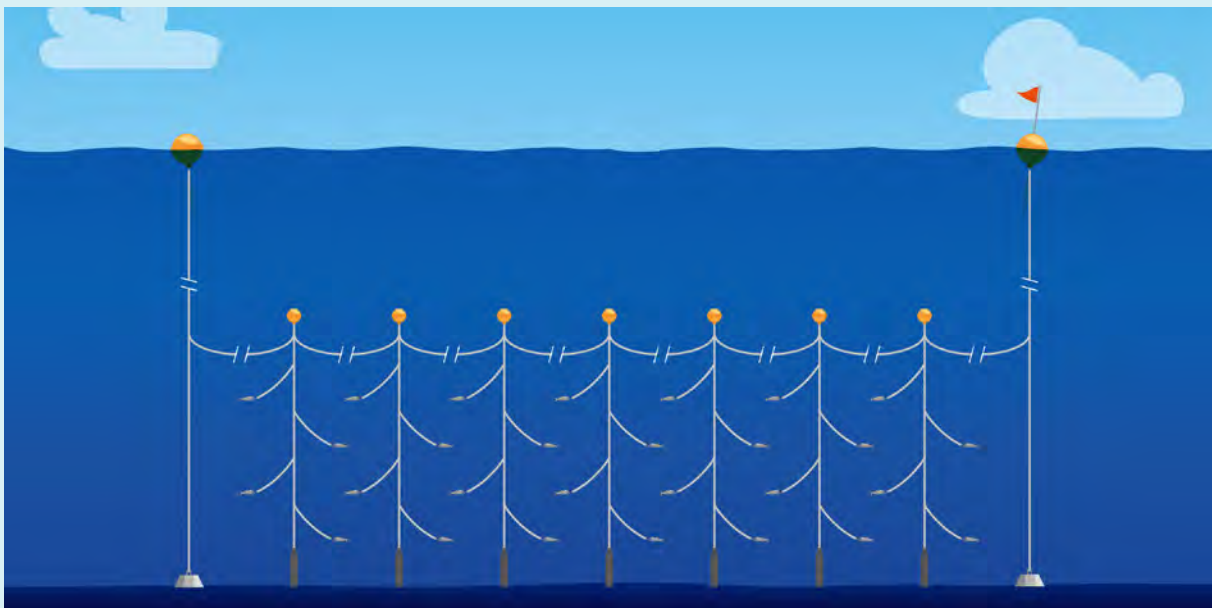

Droppers, with individual pressure-resistant floats and sinkers, are used to keep all hooks at the desired distance above the sea floor.

method ⓘ

8.1 Flyingfish scoop-netting

Scoop-netting for flyingfish is done at night, using powerful lights and a specially made long-handled scoop net. Fish are spotted, pursued individually, and then scooped up one by one as they become stunned by the light. Although flyingfish are quite small (1 kg or less), a good fisher can catch 150 or more in a night. Flyingfish make excellent eating and are good bait for other fishing methods.

Flyingfish scoop-netting is a traditional fishing method that has been practised for many generations in some Pacific Island countries. Historically, it was a group activity carried out from a paddling canoe. The lead fisher stood in the front, directing operations and scooping the fish. Behind the lead fisher stood a fire-man whose job it was to keep a torch burning and provide light for the lead fisher. And behind him were the paddlers, whose jobs were to paddle the canoe according to the lead fisher's directions.

More recently, the method has become modernised, with fishing now carried out in small, motorised boats and with battery-powered headlamps. Two people can scoop-net, one driving the boat and the other leaning over the bow with the light while scooping the fish. In French Polynesia and Cook Islands, fishers have developed a style of small boat, *poti marara*, especially for this kind of fishing. The steering and engine controls are located well forward in the boat, so a single fisher can drive and steer as well as spot and scoop fish.

This can also be done in a normal outboard-powered boat by connecting a length of pipe to the steering and throttle control. The fisher stands well forward in the boat, steering with one hand while scooping fish with the other.



Flyingfish scoop-netting.

Gear and equipment**The scoop net**

There are many sizes and shapes of off-the-shelf scoop nets available, but many are often too flimsy for the heavy work. It is best to make your own. The handle

should be 3–4 m long and made of bamboo or some other sturdy material. The frame should be round or egg-shaped and made of thinner bamboo or fibreglass rods combined with heavy-gauge steel wire. Small-mesh netting should be used for the net.



Homemade flyingfish scoop net.

Scoop net construction materials

#	Component	Description of material
1	Net handle	3-4 m bamboo or fiberglass pole, 30-40 mm diameter at the base, tapered to 15-20 mm at the tip.
2	Net frame	Use sections of bamboo, broken game fishing rods, or fiberglass rod and section of steel wire and mesh netting <ul style="list-style-type: none"> • 1 x cross piece ~200 mm long by 10-15 mm diameter (the "T" piece) • 2 x sections 400-500 mm long by 10-15 mm diameter to form the frame of the scoop net; or, alternatively: <ul style="list-style-type: none"> • go in the bush and find a suitable forked guava, citrus or other strong branch around 30 mm diameter, with ~ 20-30 cm long forks
3	Frame joiner	~ 1.5 m long, ~ 4 mm diameter, stainless or strong no. 8 fencing wire
4	Net bag	<ul style="list-style-type: none"> • ~ 1.5 m x 0.5 m panel of nylon or monofilament mesh netting, about 15-30 mm stretched mesh, 15-25 kg breaking strain, purchased or self-stitched • ~20 m of fishing line or braided line ~ 15-25 kg breaking strain could be used for stitching the net to the frame of the scoop net.
Tools and materials		Marine glue, rasp, sandpaper (40 and 80 grit), net stitching needle

The headlight

Flyingfish scoop-netting is done at night, so a strong light is essential to see what is going on and to help attract and confuse the fish. In the past, a vehicle headlight was often used, sometimes attached to a safety helmet, and powered by a car battery. Nowadays high-powered LED headlamps and helmet lights are available that are cheaper, lighter, brighter and have long-life batteries.



High-powered LED helmet light and headlamp.

Making the gear

The scoop net

1. Smooth the pole, drill a hole across it close to one end, and insert the T piece. Cut the pole 5 cm above the T piece.
2. Cut the T piece and the base tubes at the right angle so they adapt well to the piece they will be glued to.
3. Glue the different pieces with thick marine glue (epoxy or polyester). Let it well cure before proceeding. All connections can be reinforced with lashing covered with marine glue.
4. Insert the 4-mm wire in the base tubes to form an egg-shaped hoop of about 60 cm long by 50 cm wide. Glue them together.
5. Smooth all connections with sandpaper and cover the assembled parts with resin or paint.
6. Stich the mesh netting to the hoop to form a conical net bag of about 50–60 cm deep.

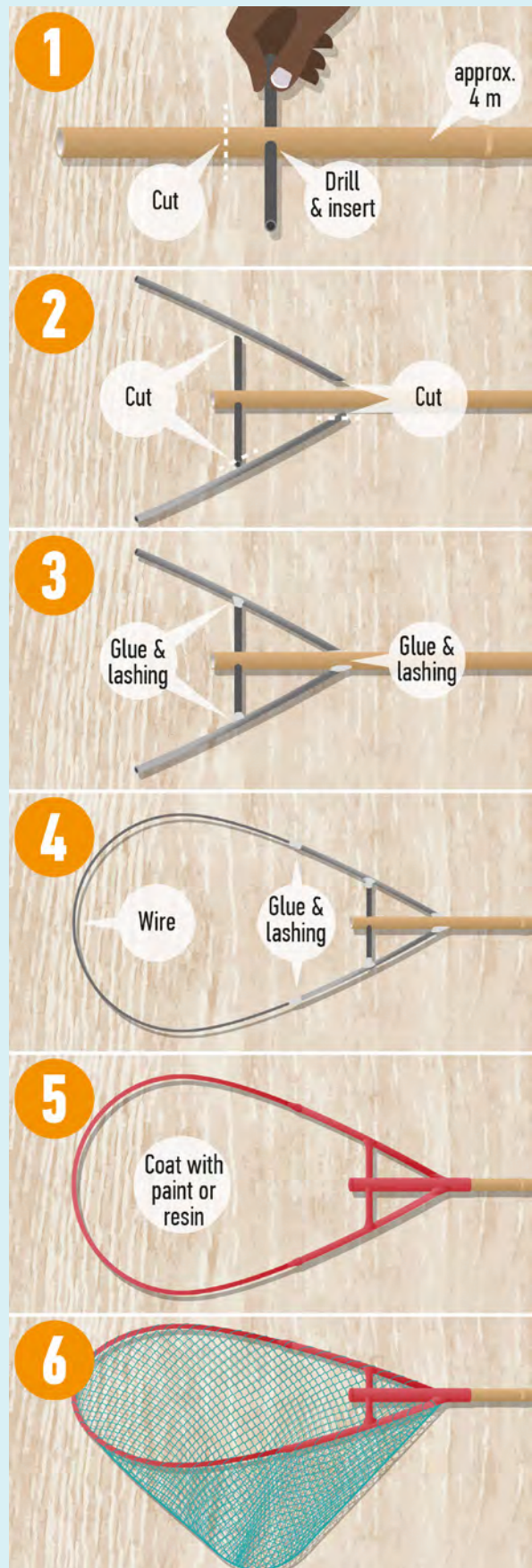

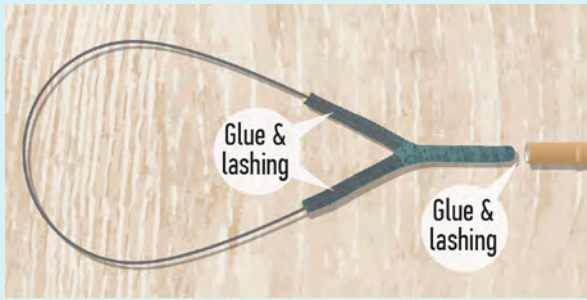

A forked branch can be used to connect the pole and the hoop.

Another method is to use a forked branch to make the net frame.

- Find a suitable forked branch of guava, citrus or other strong timber, around 30 mm in diameter and with 20–30-cm-long forks.
- Remove the bark and smooth with sandpaper so that the branch base fits in the tip of the pole.
- Join the branch and pole together by gluing and binding with braid or strong twine. Some fishers glue before adding the binding, others do the opposite.
- Bind the 4-mm wire frame joiner onto the ends of each fork to form an egg-shaped hoop that is roughly 50 cm wide by 60 cm long.
- Then, follow the same procedures as above. Bind the wire and rod connections firmly and glue, smooth the glued joints with sandpaper when the glue has dried, then stitch the mesh netting to the frame to create a conical bag about 50–60 cm deep.

Using the gear

Once the fishing gear is assembled:

- Head to the fishing ground about an hour after sunset, or when the moon sets.
- Turn on the headlamp.
- Travel relatively slowly, and look for flyingfish that are either flying or swimming.
- When you see one, keep the beam of the light on the fish and motor towards it.
- Scoop the fish from the front (head) end, not the tail end.
- With practice, you will learn to scoop flyingfish in mid-flight.

Fishing tips and tricks

- If you are fishing with another person (scoop-netter and/or boat driver), the person who wears the light leads the operation.
- The driver should follow the netter if the netter has the light. If the driver has the light, then the netter will be guided by the driver.
- Stay alert, listen, and watch for pounding surf. When working with limited light and against the sound of an outboard engine, it is quite easy to follow flyingfish right into breaking surf onto a shallow reef top.
- If you use a car battery to power your light, keep it well away from the fuel tank.



If the netter has the light, then the driver should follow the netter's instructions.

8.2 Baitfish gillnetting

Gill nets are used throughout the Pacific Islands to catch reef and lagoon fish, but they can also be used to catch baitfish.

Gillnetting for baitfish from a boat works best during the early morning or at night using lights to attract the fish. Target species are similar to those caught by baitfish jigging ([section 8.3](#)) and include scads and mackerels.

Gear and equipment

The gear includes one large gill net, one or two powerful underwater lights, and a couple of above-water lights. The gill net consists of three main parts: a head rope, a net panel and a weighted leadline or footrope.

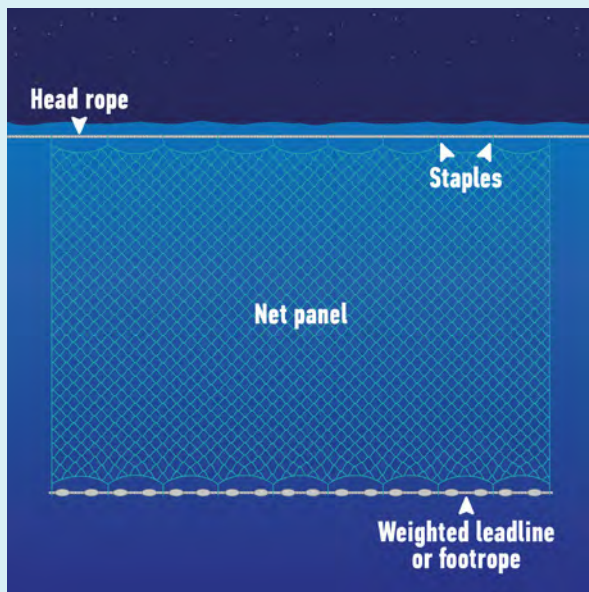

The three main parts of a gill net.

Making the gear

The net should be made from monofilament nylon panels that are a bit shorter than the length of the boat, and 5–10 m deep. Gill nets are often sold in panels of 25 m by 2 or 3 m, which is more than enough to make a net for a 10–15-m boat. A stretched mesh size of 4 cm is ideal, but a little smaller or larger will also work. Make sure the mesh size you use is legally permitted in your location, as many Pacific Island countries prohibit small-mesh nets in order to protect under-sized reef fish.

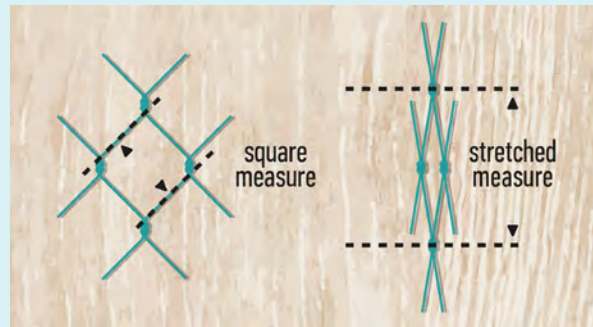

Ways to measure mesh sizes.

The net panels are attached to the headrope and footrope using twine. The twine is threaded through four or five meshes, hitched around the rope in a clove hitch (see [section 4.2](#)) or similar knot, then threaded through another four or five meshes, and so on. The lengths of twine separated by knots are known as staples. Threading the staples, joining net panels, and making repairs to the net are made much easier by using a netting needle. Plastic netting needles are usually available in the same places that sell net panels.

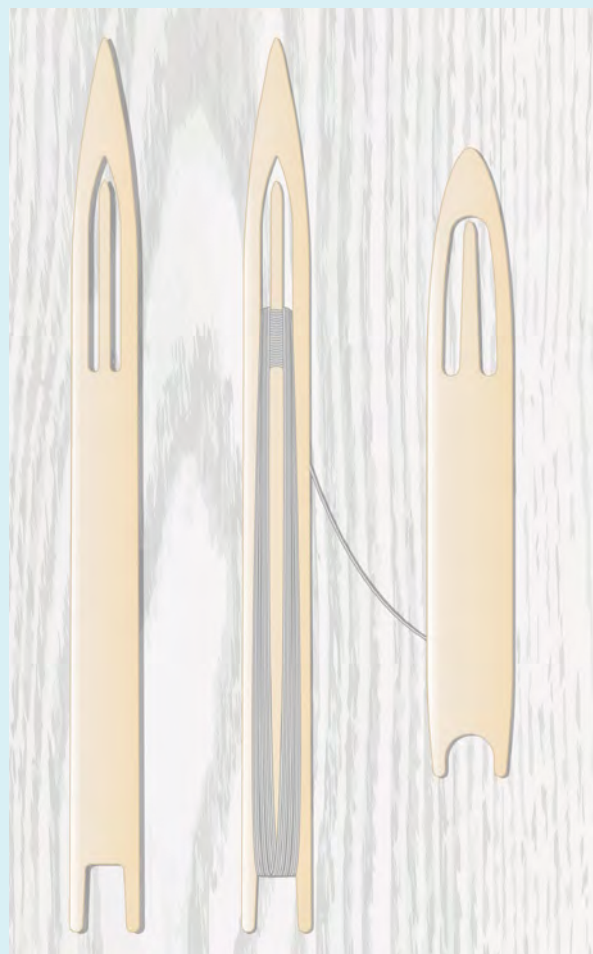

Netting needles

When attaching the net panel to the headrope, the staples should be spaced so that the net hangs quite loosely. If the net is stretched too tightly, fish will not become caught as easily. As a rule of thumb, use a

hanging ratio of about 50%: meaning that 1 m of mesh panel should be hung on 50 cm of rope so that it is loose and slightly bunched up.

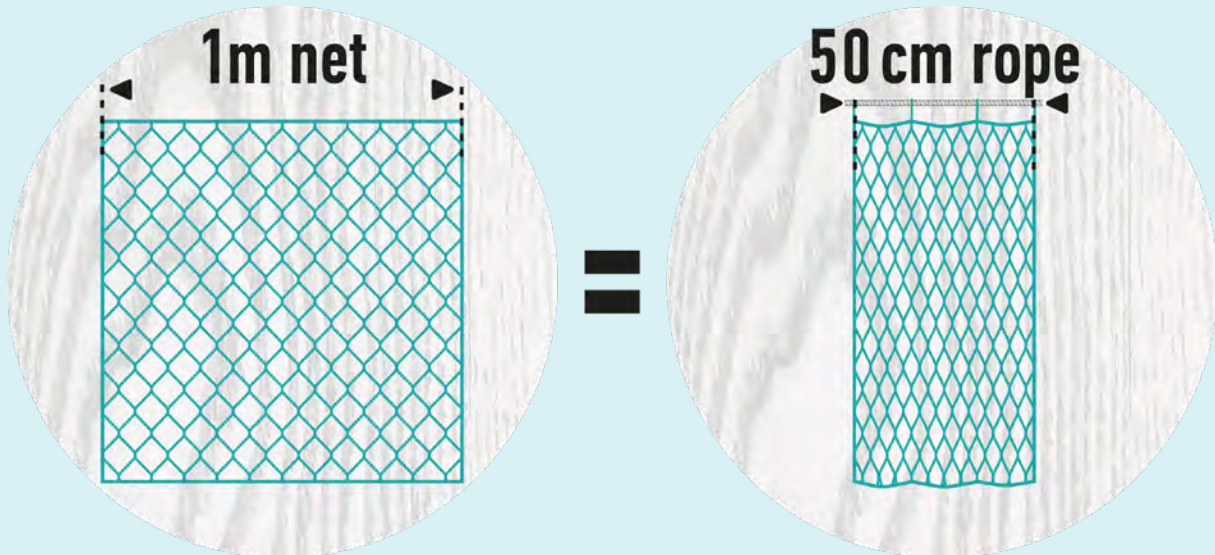

Attaching 1 m of net to 50 cm of head rope (using a 50% hanging ratio) makes the net hang quite loosely.

Gill nets that are used in open water need floats along the headrope and sinkers on the footrope to stop the net from collapsing into a useless bundle. When fishing from a boat, there is no need for floats because the net is simply hung over the side from the gunwale. But, the footrope still needs to be fitted with sinkers to give the net some structure and keep it open vertically.

Sinkers can be simple lead weights threaded onto the footrope, or small pieces of sheet lead folded onto it. Lead-cored rope is available in some locations and can be a better option, although it is three or four times more costly than using simple lead sinkers.

Another alternative is to attach one or more sections of rebar to the footrope. This acts as a good sinker and helps keep the net stretched open lengthwise when hauling, which makes it easier to remove the fish. And rebar is a lot cheaper than lead sinkers or lead-cored rope.

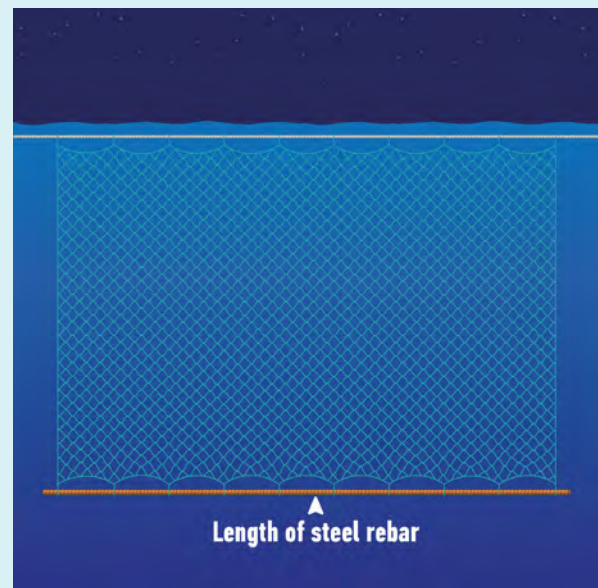

Using a length of rebar as a footrope.

Another advantage is that when the net is not being used, it can be rolled around the rebar for storage. Because there are no floats, the net is quite compact when rolled up this way, and can be slipped inside a length of PVC drainpipe so that it stays tangle-free during storage and transportation.

Using the gear

Fishing is very simple:

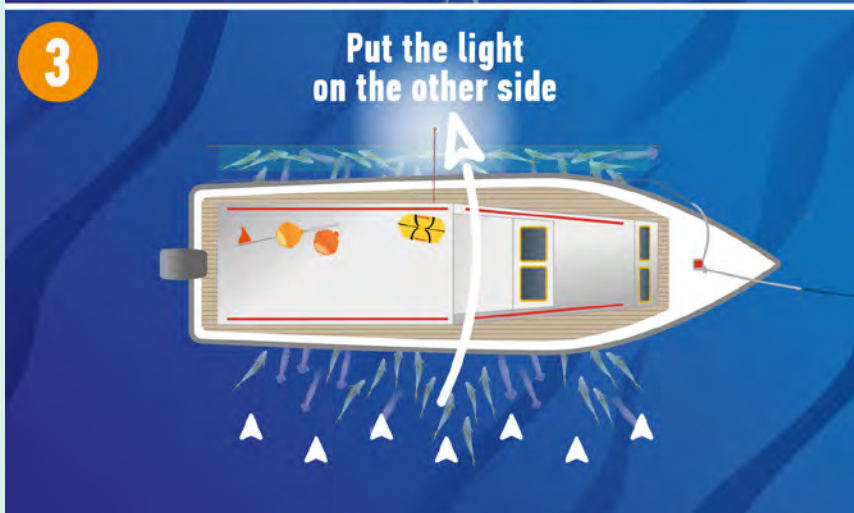
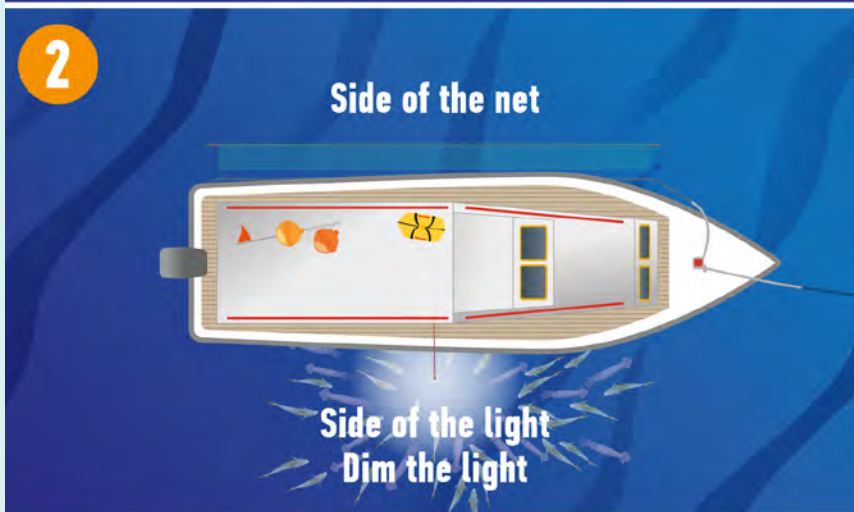
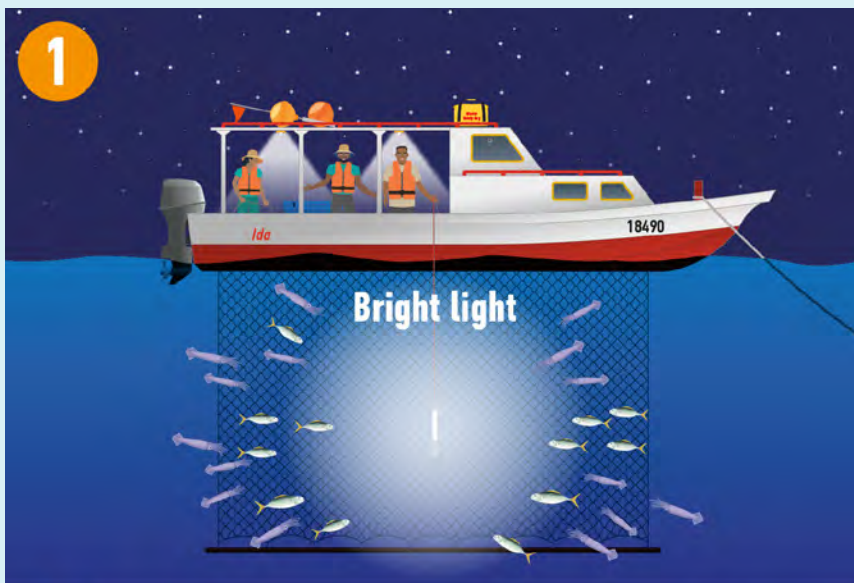

1. Once the sun sets, power up the underwater fishing light and lower it over one side of the boat, and hang the net over the other side.

2. Keep an eye on whether fish are gathering and, if necessary, slowly dim the light to bring them closer together.

3. When enough fish have gathered around the underwater light, swing it to the other side of the boat, outside of the net. The fish will swim towards the new source of light and get caught in the net.

Baitfish gillnetting tips

- Once your fishing spot has been selected, anchor the vessel, and observe the direction of the current and its strength.
- Try to avoid fishing where the current is strong.
- Where possible, fish on the leeward side of reefs and shoals where the current is weaker.
- Take note that the current is at its weakest at the peak of high tide and the ebb of low tide. Sometimes, you may only have a window of 15 minutes of low running current to perform your baiting operations with ease.
- In some circumstances, it may be necessary to anchor the boat across the current for best results. This can be done by attaching a bridle to the front and back of the boat and tying the anchor to the centre of the bridle, or by moving the anchor line to the middle of the boat.
- Once the boat has swung around and the bait has gathered on the side of the light again, swing the light to the opposite side of the boat and have someone gently slacken the anchor rope so that the boat drifts towards the net but not over it.
- Make sure that the weight of the rebar is sufficient to hang the net, but not too heavy, as this will stretch the net and the fish will bounce off the mesh. Observe predator activity in the area; sometimes you may have to retrieve the net before it gets damaged by predators attacking the netted bait.

8.3 Baitfish jigging

As well as being good food for people, small fish are excellent bait for many fishing methods. They can be caught quite easily by jigging with tiny hooks dressed with feathers, tinsel, luminous threads, coloured beads, or glow-beads protected by plastic or fish skin

Baitfish jigging also catches island mackerel and short mackerel, which are both plankton feeders but are, nevertheless, attracted to certain kinds of jigs.

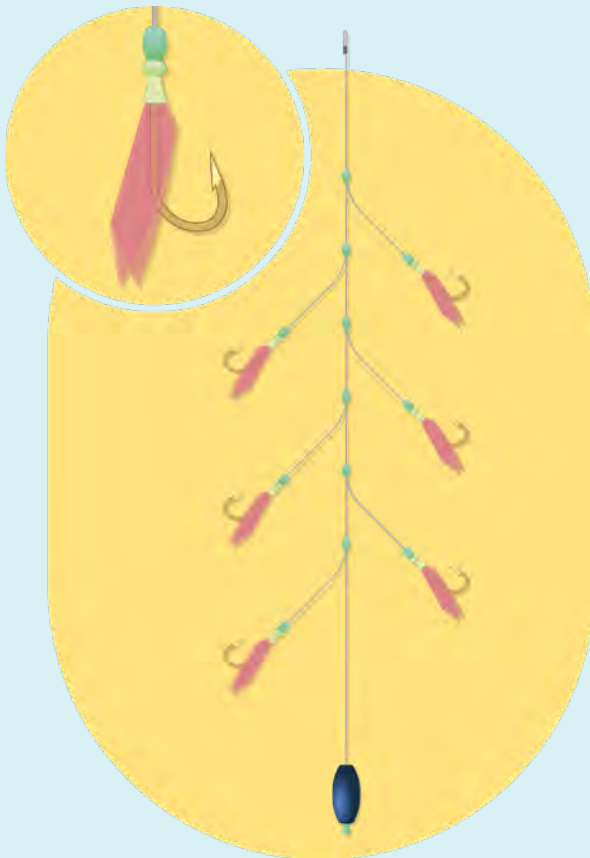

A typical setup for baitfish jigging.



Mackerel scad



Bigeye scad



Indian mackerel

Baitfish jigging can be done from canoes and other small boats. This method works well around FADs and can be done during the day or night.

This method targets mackerel or ocean scad, bigeye scad and Indian mackerel among other fish.

Gear and equipment

Commercially manufactured baitfish jigging hooks are available, and often sold as sabiki rigs made up of a trunkline with half a dozen hooks arranged in a Christmas tree pattern. But, lures can also be home-made using feathers or fibres whipped onto small hooks. Making complicated baitfish jigs can be fiddly and time-consuming, but more basic methods using frayed rope cutoffs, plastic strips or sliced-up drinking straws are quicker and often just as effective.

Making the gear

Making baitfish lures is similar to tying flies for trout and salmon fishing.

- Pass the lure material (wool, feather, raffia, floss, white-dog hair, goat or pig hair, or whatever you have on hand) through the eye of the hook.
- Bend the material back over the shank of the hook and bind it with cotton thread.
- Cut the lure material below the bend in the hook.
- Make lots of lures in various colours (but plenty of white ones).

Once the lures are made, attach each one to a branchline, and then attach the branchlines to the trunkline with a swivel at one end of the rig and a sinker on the other.

Using the gear

The baitfish jigging rig is attached to a light mainline with a snap swivel. It is then lowered or cast over the side of the boat and jerked repeatedly up and down until one or more fish strike the hooks. A fishing rod makes the up-and-down jigging motion less tiring on the arms.

When a fish is hooked, swing it into the boat, unhook it, and get the gear back into the water for the next catch.

If you happen to hook a large fish, you may need to use a landing net to make sure it does not fall off the hook before you can bring it into the boat. For small fish, a landing net is not needed. In fact, a landing net can be more of a nuisance than a help when using a sabiki rig, because the multiple hooks can get caught in the mesh of the net.

Baitfish jigging can be done on shore, from seawalls or jetties, or by casting out and then quickly retrieving the line before it hooks on the bottom.

But this method is most effective when done at night from a boat, using lights to attract baitfish. In many cases, the lights attract both squid and baitfish, which can be caught with squid jigs. The fishing process is as follows:

- Head out to the fishing area around dusk.
- Anchor your boat in depths of 10 m or more if fishing in

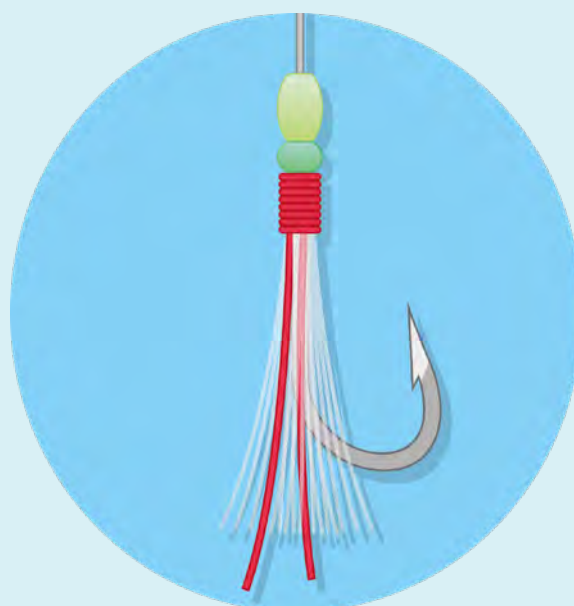

Home-made baitfish lures

the lagoon or set a sea anchor if fishing on the ocean side of the reef.

- Place the light over the side of the boat and turn it on.
- Prepare the fishing gear while waiting for the baitfish to aggregate.
- After 30–60 minutes, drop the jigs. If fishing outside the reef, drop them to depths of 15, 20, 30 and 50 m and then retrieve them by jigging.
- Take note of the depth where fish start biting, and then set that as your fishing depth.
- Drop the rig a few metres beyond the chosen fishing depth and haul it back in.



Baitfish jigging using under and above-water lights.

Baitfish jigging tips

- Baitfish jigging at night is best done during a new moon (first and last quarters) when there are more hours of darkness. This makes the lights more effective at aggregating fish.
- When hauling in the catch, retrieve the line steadily.
- Prepare a landing bucket or icebox to drop the fish into immediately after bringing them onboard. This will prevent them from jumping all over the place and tangling the lines.
- Always pull the entire rig into the boat and then unhook each fish. Never leave one or two jigs in the water while you remove a fish – you may end up with a shark attacking the hooked baitfish or another strike that pulls hooks into your finger.
- As the night wears on, gradually dim the lights. This will cause the baitfish to come closer to the light, concentrating the shoal and making them easier to catch.
- Choose well-separated fishing spots on the boat so that all the fishing lines are clear of each other. It is a waste of precious fishing time to untangle light fishing gear at night.
- Finally, if using a 12-volt battery to power the fishing lights, make sure it is well away from the fuel tank.

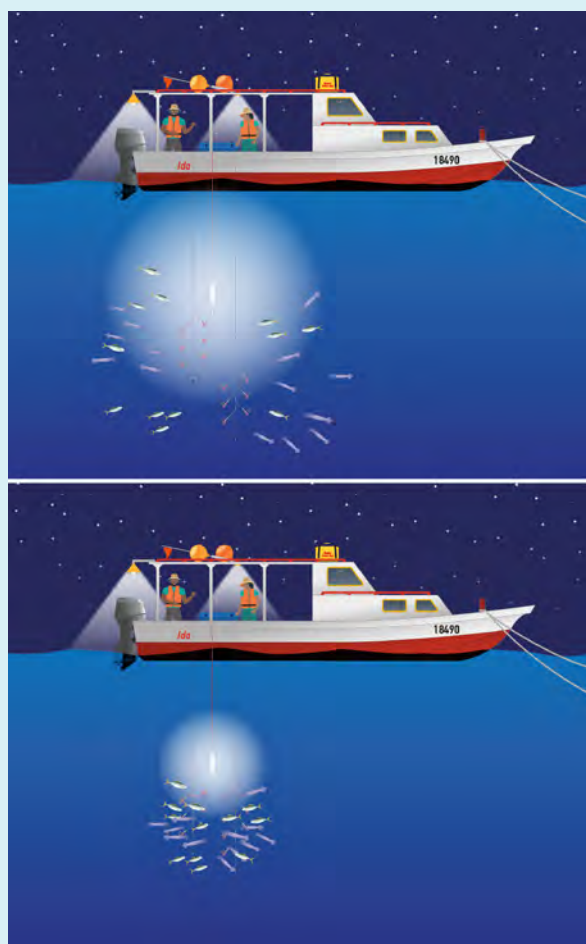

Use a bright light first to attract the bait from a distance, then dim the light to concentrate the bait near your lures.



8.4 Pencil squid jigging

Pencil squids are one of the most widely found groups of squids, and they form the basis of important fisheries worldwide.

In other countries, large quantities of pencil squid are caught by trawling, but in the Pacific Islands, fishing is mostly by jigging. Pencil squid are strongly attracted to light so most squid jigging is done at night.

Pencil squid jigging is quite different from the deep-water vertical longlining fishing method used to catch diamondback squid (see [section 6.10](#)). Pencil squids are much smaller (usually less than 2 kg) and, as well as being used for human consumption, are often used whole for fishing bait.

Gear and equipment

Commercial-scale pencil squid fishing uses handlines or reels to operate a long mainline equipped with 20 or 30 squid jigs arranged in a string, one above the other. The jigs are strung in 0.5–1.0 m intervals along the first 30 m of the mainline, but the fishing depth may be 150 m or more. The line is repeatedly paid out and retrieved with a jerking movement. Bright lights arranged above the deck create a zone of shadow beneath the vessel, and as the jigs move in and out of the shadow zone the squid attack them and become hooked.



The bigfin reef squid, a pencil squid found throughout the Pacific Islands.

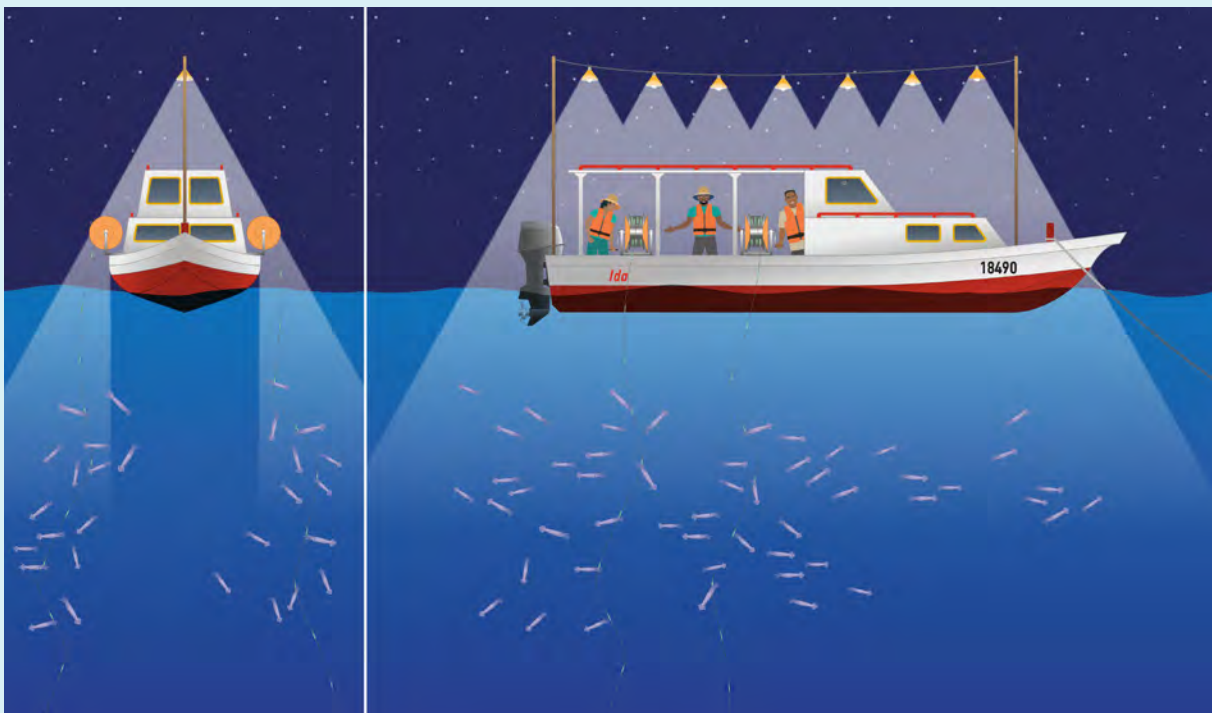

Lights placed above the deck create an area of shadow below the boat. Lures are jigged along the light/shadow limit where squid concentrate.

There are many kinds of squid jigs, most of which are commercially made, and which carry one to three circles of sharp barbless hooks around the tail. Jigs used in commercial operations generally have a ring at each end so they can be arranged top-to-bottom along the mainline. But some squid jigs are designed for use on a rod and reel, and are weighted so that they are in a horizontal position when they are retrieved after being cast out.

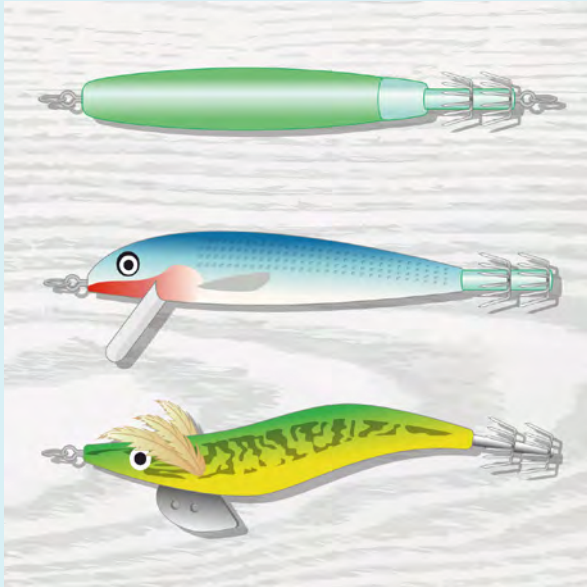

Manual reels certainly make the fishing operation less tiring, and electric or hydraulic reels are better still.

Making the gear

If you decide to pencil squid jig using a reel, make sure the line guide arrangement is modified to handle both the jigs and the squid that are being hauled in. Most fishing methods use a pulley, sheave, U-bolt or telephone spike insulator to guide the line onto the reel. But, this does not work when squid fishing because the jigs and hooked squid will not pass through. Instead, you can install a wide roller about a metre or so away from the reel, with a catching tray underneath to catch the squid as they drop off the jigs. In the following illustration, the squid fall from the jigs after they cross the roller, and then slide down into the ice box below.

Top: jig with a ring at each end that can be mounted in a string of jigs.

Middle and bottom: jigs designed to be used individually with rod and reel.

Although pencil squid jigging can be done by hand, repeatedly lowering a 150-m mainline and then retrieving it while jerking the line is exhausting work. Most fishers use reels, such as the home-made hand-cranked version shown to the right. A standard wooden hand reel can also be modified for this purpose by cutting two of the arms down to half the original length to create the required jerking motion.



Small boat squid jigging setup, using modified FAO wooden hand reels and wide rollers.

Using the gear

The lines should be marked every 5 m or 10 m, so you know at which depth the squid are biting. Once the vessel and equipment are ready, the fishing operation is simple:

- *Head out to the fishing area around dusk.*
- *Move 0.5 nm to 1 nm away from the reef, on the ocean side, and lay out your sea anchor.*
- *Take note of the drift.*
- *Turn on all the overhead lights and ensure that they run amidships down the length of the vessel.*
- *Place the underwater light over the side of the boat and turn it on.*
- *Prepare the fishing gear while waiting for the squid to aggregate.*
- *At the first sign of squid in the area turn off the underwater light.*
- *Drop the jigs to depths of 100 m, 150 m, or 200 m.*
- *Retrieve the lines with a steady winding of the reel at one second per rotation.*
- *Take note of the depth where squid starts tugging and getting caught on the lures, and then set that as your fishing depth.*
- *Drop the rig a few metres beyond the chosen fishing depth and haul it back in.*

Although pencil squid jigging is generally done at night, squid can also be caught during the day. This generally requires fishing in much deeper waters though, up to 500 m.

Pencil squid jigging tips

Similar to baitfish jigging, pencil squid jigging at night is best done during a new moon (first and last quarters) when there are more hours of darkness. This makes the lights more effective at aggregating squid.

When pencil squid jigging at night:

- *When hauling in the catch, retrieve the line steadily and do not slack back otherwise the squid is likely to get unhooked.*
- *Prepare a landing bucket under the receiving tray so that the squid falls directly into the bucket as it is brought aboard.*
- *Wash off any sprayed squid ink as soon as possible to prevent it staining the boat. Do not let it dry.*
- *While carrying out the fishing operations, always keep an eye on the vessel's proximity to the reef.*
- *If required to move away to deeper waters, haul in the sea anchor and motor away at dead slow speed so that the aggregated squid can follow the boat's lights and it won't take long to settle into the fishing routine again once you get far enough away from the reef.*

9 After fishing

9.1 Care of the boat

Nearshore fishing places heavy demands on a small boat and its equipment. Thrashing fish can damage paintwork, fittings and deck equipment. Fish slime and blood will stick to surfaces, making them slippery and dangerous. Scales and scraps of fish waste collect in bilges and corners, blocking pipes and drains and making the boat stink. Salt spray accumulates everywhere, causing electrolysis or corrosion of metal fittings, causing moving parts such as jinges and

joints to seize up. Your boat will gradually deteriorate unless it is properly cleaned at the end of every day of fishing, and receives basic maintenance on a regular basis.

General cleaning

At the end of the day, or during a lull in the fishing, throw buckets of sea water over the decks and interior surfaces of the boat, and clean off any spots of blood or slime with a stiff brush or a rag.

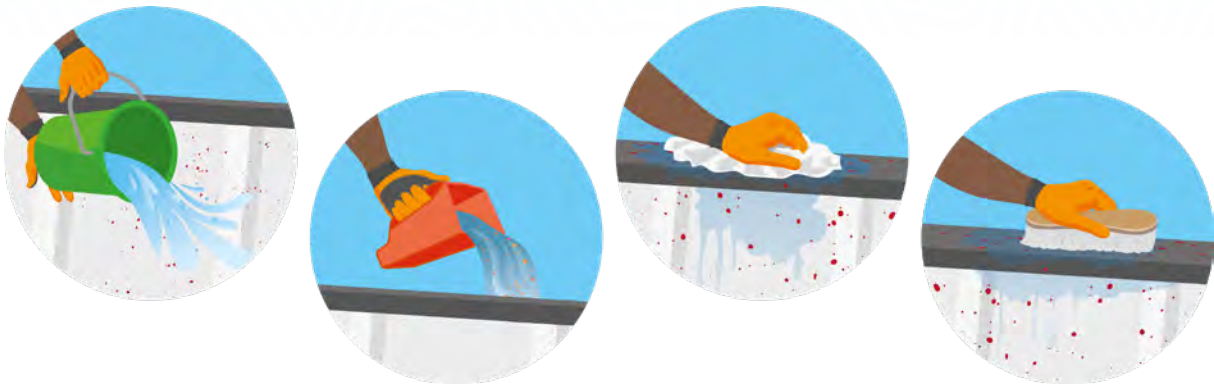

Use buckets of seawater to remove blood and slime.

Metal fittings

When the fishing trip is over, wash or wipe down any metal fittings or moving parts with fresh water. This will remove salt and fish scales, and help prevent the

fittings from rusting, jamming or developing dangerous rough or jagged edges.

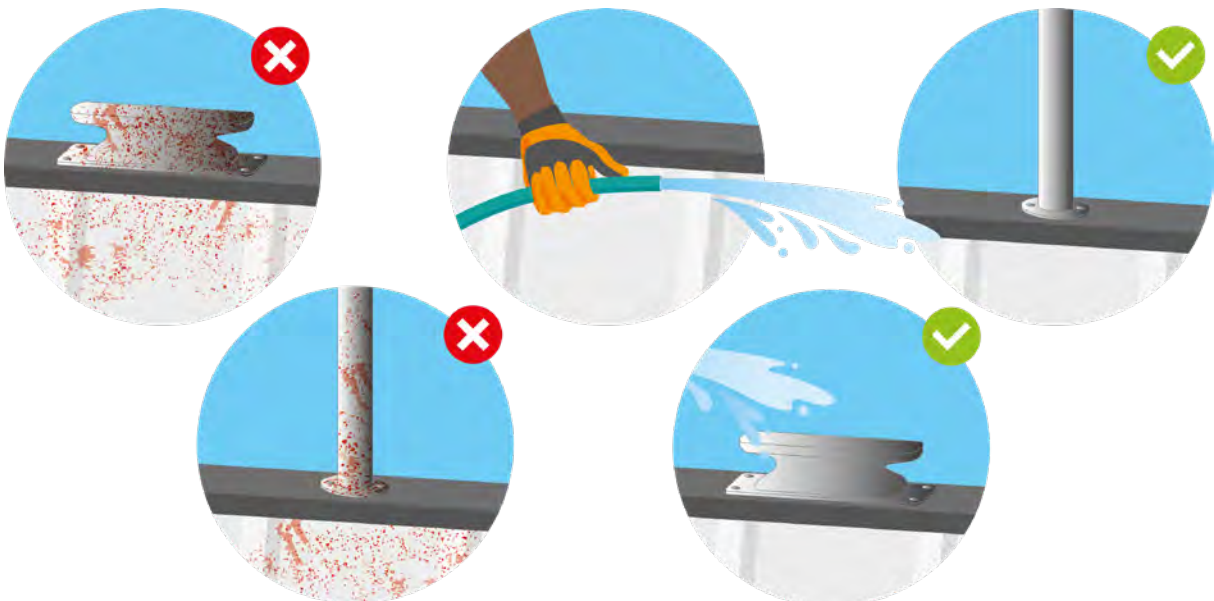

Clean and wipe all metallic parts with fresh water.

Anchor

Check the anchor to make sure that the prongs have not become weakened by too much bending.



Straighten out any bent anchor prongs.

Repairs

Back in port, make a note of any damages that may have occurred such as broken booms or lost deck equipment. Carry out repairs or replacement as soon as possible, before forgetting about them, or before the issue becomes serious or dangerous.



Make a checklist of needed repairs or gear replacement.

Engine maintenance

When the engine has cooled off, wipe or wash the exterior surfaces of the engine with a rag dipped in **fresh water**. After the engine surface dries, wipe it with an oily rag or spray with a light lubricant oil for protection. Treat any moving or corrosion-prone metal fittings in the same way. Check your outboard motor's "User Manual" for all the greasing points. Use a "grease gun" to grease up the mounting brackets and all grease nipples or cups on the motor tilt mechanism, steering linkage (swivel bracket), and steering arm tiller after every trip. Do not overfill grease when lubricating the points. Once the grease starts spilling over, stop and wipe off excess grease from around the grease nipple.

Check the engine and gearbox oil, and regularly change the oil. Most manufacturers recommend you change your engine's oil every 50–100 hours of operation, or once every year, whichever comes first. If possible fit sacrificial anodes (see [section 9.3](#)). Sacrificial anodes are attached to a motor or metal hull, they protect metal components from electrolysis.



Wipe the engine with a clean rag and fresh water, check the engine and gearbox oil.

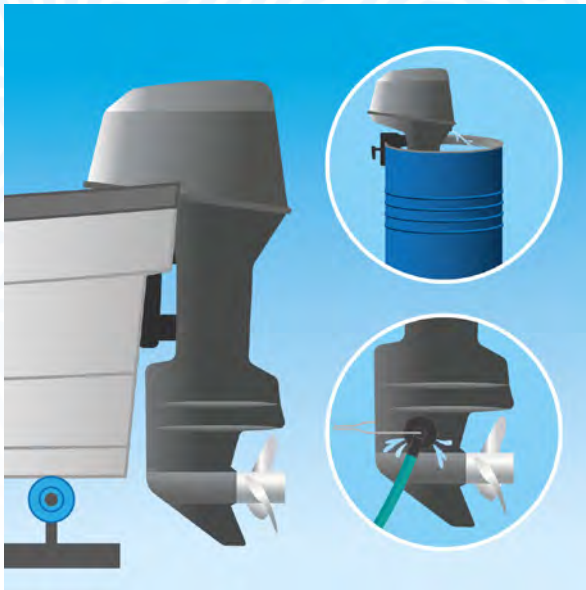

Flush the outboard engine cooling system with fresh water.

If the engine is an outboard, flush the engine cooling system with fresh water. This can be done by removing the engine from the boat and running it in a drum of fresh water. If the outboard is permanently mounted on the boat, use a commercially available (or improvised) flushing device, fitted on to a water hose, to supply fresh water to the engine cooling intake.

Hull exterior

Allowing weeds and barnacles to grow on your hull will slow your boat down considerably, and you will use a lot more fuel. In wooden boats, this can lead to serious damage by wood-boring worms and rot. Repaint the hull with anti-fouling paint every 9-12 months or as often

as necessary. In between times, keep the hull clean by brushing or wiping with a cloth. Be careful not to damage the paint surface when you clean the bottom of your boat.

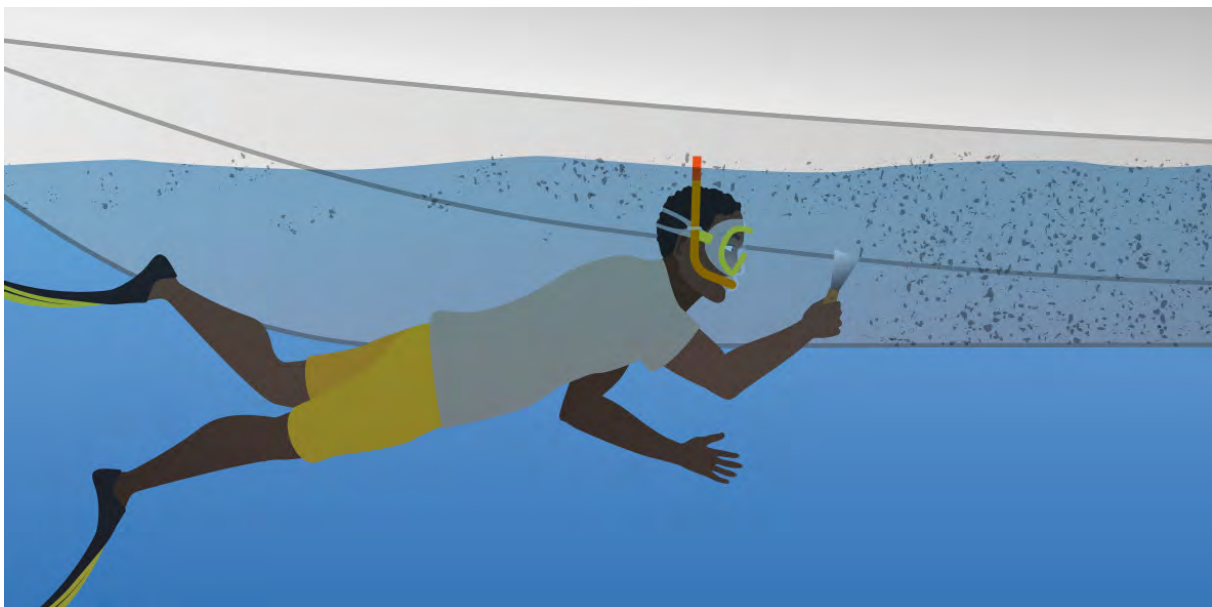

Scrape or wipe off weed and shell growth on hull, but be careful not to gouge the hull or scrape off the antifouling paint.

9.2 Care of the fishing gear

Like the boat, fishing gear suffers damage and deterioration during use, and after the fishing trip

the gear needs to be cleaned, maintained and, where necessary, repaired.

Cleaning and rust prevention

Wash all fishing gear in fresh water to remove encrusted salt. Scrape off any blood and slime, and ensure the gear is properly dried before storing it. Use a light oil to spray tools. Use fresh water, dish washing mixture and a spray bottle to lightly spray the echo sounder. Wipe the screen with a nonabrasive cloth.



Clean and rinse all fishing gear in fresh water.

Hooks, swivels, crimps and knots

Check all hooks to make sure they are sharp and have not been bent. Also check swivels to see that they have not corroded or become bent and that they still turn properly.

Hooks can be sharpened with a small three-cornered file and sandpaper, but this then removes the galvanised coating from the hook and increases the rate of rusting. Continued use of rusty hooks to save money is a false economy as they will result in fewer fish caught. The same applies to hooks that have been bent by a large fish. These should be discarded. Attempting to bend hooks back into shape will weaken them and they may break or straighten when taken by the next big fish.

If you do have corroded hooks and tackle that need to be cleaned, you can use a mixture of vinegar and baking soda, which makes a cleaning solution that will remove the worst of the rust.



Make sure the hooks you use are clean and sharpened.

Examine knots, twists, end loops and sleeves to make sure they do not slip or come undone. Cut out and repair as necessary.

Check over lines for abrasion, kinks, knots or other damage. Repair or replace sections that appear to be significantly weakened.

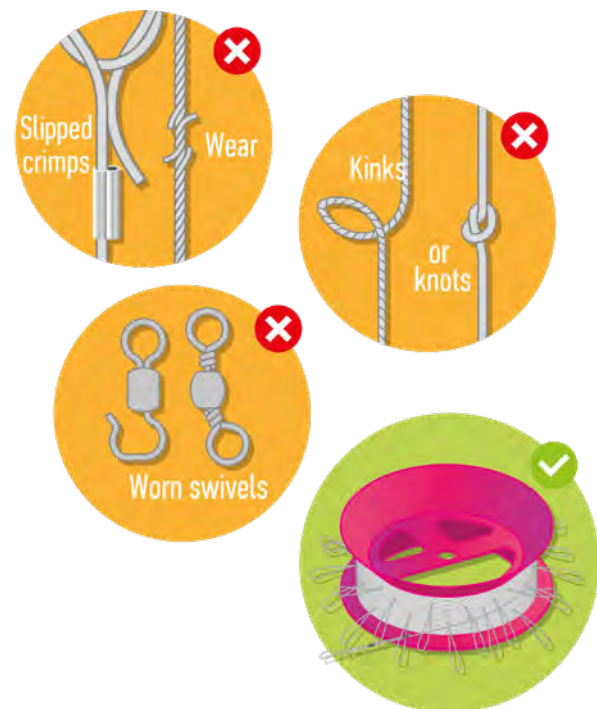

Check all lines and connecting pieces.

Clean rust and tarnishing from metallic lures, and touch up badly damaged paintwork on hard lures. Add more skirt material to badly torn octopus, feather or other soft lures.



Touch up and repair damaged lures.

If possible, place bags of silica gel or other moisture absorber inside your fishing gear storage box to keep things dry. Silica gel – a natural mineral called silicon dioxide – absorbs water from the air up to 40% of its own weight, and can be re-dried in the oven from time to time. Small silica gel sachets are often packed with dry foods, leather goods, electronic items or other products that need to be kept moisture-free, and these are ideal for keeping fishing tackle dry.



9.3 Rust and corrosion

Everyone who has spent time on a fishing boat is familiar with the problems caused by rust and corrosion of fishing gear, equipment and even the vessel itself.

Types of corrosion

All metal items used on a fishing boat are susceptible to some form of corrosion, although some metals, such as stainless steel, brass and bronze, are less of a problem than others, such as aluminium or steel. Damage can be kept to a minimum through proper cleaning, maintenance and storage.

Fighting rust on fishing gear

To prevent rusting and corrosion of fishing gear, always:

- wash the gear with fresh water after use, then let it dry;
- spray all metal parts of gear with light oil, or wipe them with an oily rag (but try not to get oil on plastic or feather lures); and
- store gear inside a tackle box or other dry container.



Silica gel and cat litter can be used to absorb humidity in fishing gear boxes.

Protecting the boat and equipment

The most important way to protect a metal boat hull or underwater metal boat parts is to use a “sacrificial anode”. This is a block of a metal (often zinc) that absorbs the corrosion. The anode must be fixed directly to the thing that is being protected, such as the hull, propeller shaft or an outboard motor. Many outboard motor manufacturers supply anodes specifically designed to fit on their brand of motors.



Some outboard motors carry multiple anodes.

Other important ways to reduce the effects of corrosion on metal fishing boats and equipment include:

- Use stainless steel fittings whenever possible.
- Try not to connect metal items directly together. Insulate them from each other by using plastic or rubber washers, bushes or other non-metal fittings.
- Apply anti-corrosion paint, oil or grease, especially to deck equipment and fuel tanks.
- Always wash down the boat and equipment with fresh water at the end of a fishing trip.
- If you live near a river, try to anchor the boat in fresh water, where the effects of corrosion will be less than in seawater.
- And above all, make sure not to let copper (such as a piece of electrical wire) lying around on the bottom of an aluminium hull as it will create electrolysis that may quickly end with a hole in the hull.

It will never be possible to eliminate corrosion completely, but with proper care, the negative effects can be kept to a minimum.

9.4 Care of the catch

Fishers can usually expect to get more money for their catch if it is well handled and cared for. Taking care of the catch begins from the minute the fish is landed onboard, until the fish has been sold or otherwise disposed of.

Cleaning and icing

If the fishing trip is longer than a few hours, then ice must be carried, and the fish iced down as soon as possible after capture. Alternate layers of ice and fish in the ice bag/box. Place each fish belly down if it has been gutted, and surround it with plenty of ice to cool it quickly. Use as much ice as fish to ensure good chilling.



Use alternate layers of fish and ice.

At intervals during the fishing, and at the end of the fishing day, make sure that all fish have been cleaned and iced. If the fish have been in the ice box for hours or days, check to make sure there is still ice, and that the ice surrounds the fish. Repack the icebox if necessary.

In some locations, the market requires fish to be landed whole; in others, consumers prefer fish to be cleaned, gutted, gilled and scaled, or some combination

of these. If the fish needs to be cleaned, this should be done soon after the fish has died.

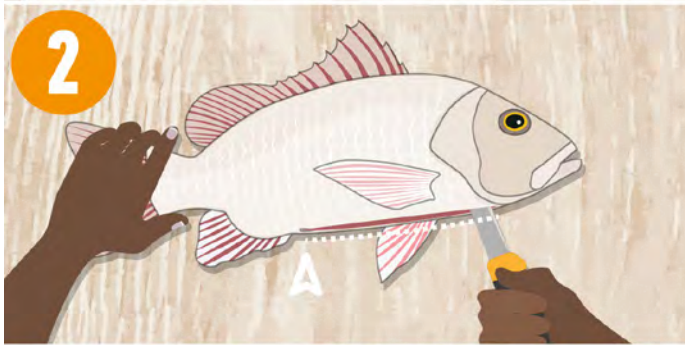
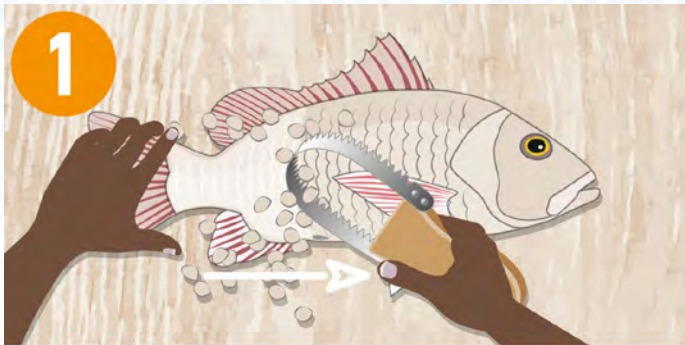

1. It is easier to scale the fish when it is whole. But if the fish is to be put in ice, scaling should only take place before the fish is sold or consumed because ice will “burn” the skin, remove its colour and probably make bumps and hollow parts in the flesh.

2. Slit belly from the anus to throat. Don't cut through the throat.

3. Remove the gills.

4. Remove the guts. Be very careful when removing the guts and scrubbing the cavity not to damage the gut cavity protective membrane. Any “cracks” in this membrane will be an entry point for bacteria.

5. Thoroughly scrub and rinse the gut and gill cavities.

Bleeding

If the fish will be sold as loins or fillets, it is worth bleeding them while they are still alive. This ensures that the flesh will keep a more uniform colour, which is especially important when fish are filleted. Bleeding also helps remove lactic acid that builds up in the fish's body when it is struggling on the line, and which can cause the flesh to become soft and jelly-like.

To bleed a fish, make an incision into the heart region behind the bottom of the gills or in front of the pelvic fins; and/or make a 2-cm-deep cut with a short blade knife on each side of the fish, 5-10 cm behind the pectoral fins.

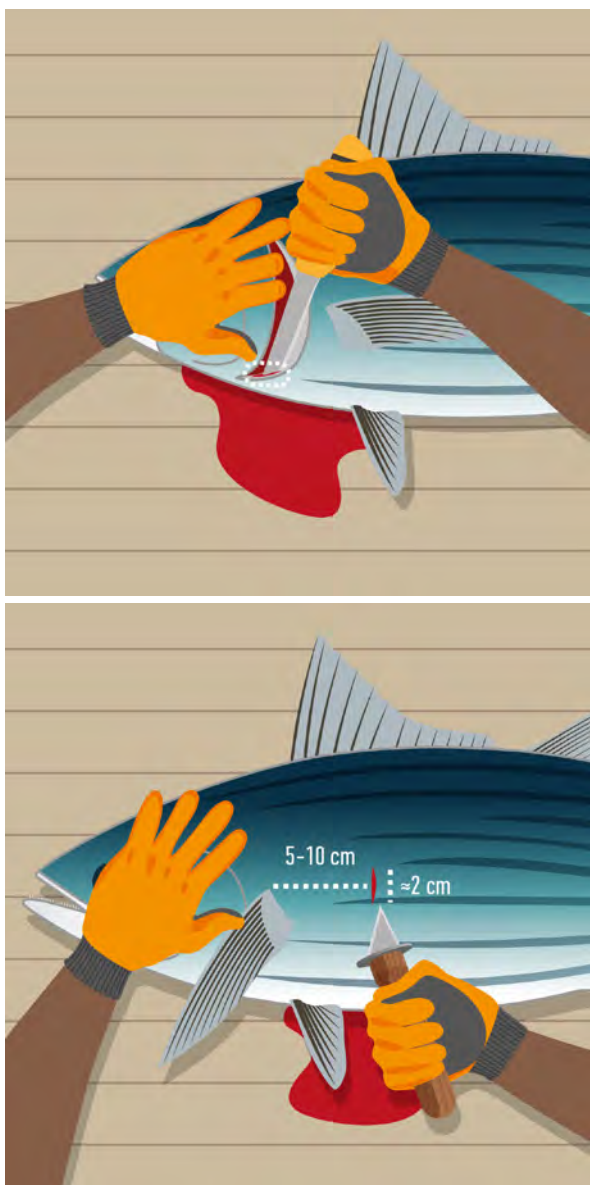

Two ways to bleed a fish.

The SPC manuals *Deep-bottom fishing techniques for the Pacific Islands* and *Onboard handling of sashimi-grade tuna* provide more detailed instructions on how to properly prepare deep-bottom fish and tuna for export or for other high-value markets.

9.5 Keeping records

Keeping records of your fishing and business activities makes it possible to monitor your performance, and to improve on it. Keep notes during each fishing trip, and then write them up properly once the trip is over. Many fisheries agencies will provide logbooks, or applications and technical assistance to help you keep good records.



Use a log book to keep notes of each fishing trip.

Catch and effort

By recording the number, weight and type of fish you catch and the area where you caught them, you can build up a valuable log of your successes and failures over a period of years. This can be a useful reference for the future, reminding you of where your best catches came from during a given season, or the best depth, time of day, tide or moon phase to fish in a particular area.



Record details of your catches.

Engine hours

In addition to the information on fish catches, records on the boat operations should also be kept. In particular, details of the number of hours the engine has run should be written down. This makes it possible for you to know when you should carry out basic maintenance procedures, such as oil changes, in accordance with the manufacturer's recommended procedures. Doing this will avoid dangerous and costly breakdowns and engine down-time.



Record details of engine use.

Fuel consumption

By recording how much fuel you used on each trip, and knowing the number of hours the engine has run, you can calculate the average fuel consumption per hour of engine run time. This allows you to properly estimate the amount of fuel consumed on long trips, and makes it possible for you to keep track of whether the boat is continuing to perform efficiently. If fuel consumption per engine hour starts to increase over a period of several trips, this may be an indication that your engine is not functioning properly. An increase in fuel consumption can also be caused by growth on the hull, which slows the boat down, or by damage to the propeller.

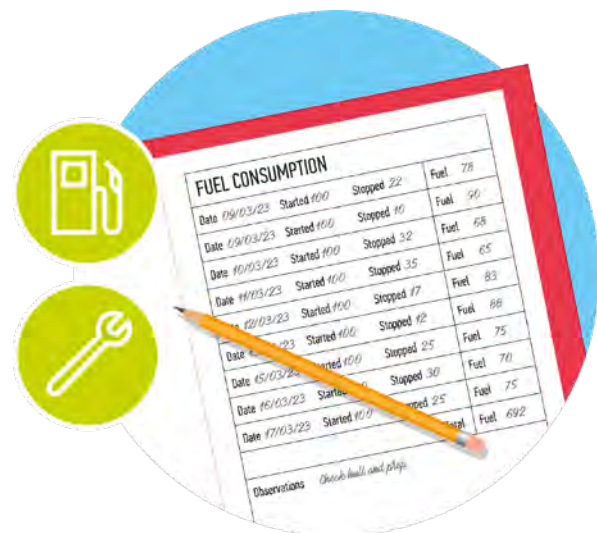

Record details of fuel consumption.

Financial records

If you are a commercial or semi-commercial fisher, you should keep a running record of the money you spend on fishing, and on your earnings. This should include the cost of fuel, bait, crew wages, ice, rations, vessel and engine maintenance, repairs, gear, bank loan and interest repayments. By balancing this against the income you receive for the sale of fish, and from any other activities (occasional charters, transport jobs), you can see just how much profit you are making, and areas where you can save money.



Record details of your expenses and incomes to evaluate the profitability of your fishing activity.

Keeping receipts of all your expenses is essential if you want to claim against them when paying income tax. Even more importantly, proper records are vital if you apply for a bank loan or a development grant.

10 Appendices

10.1 Appendix 1: Safe operation plan

The following pages show a typical safe operation plan that can be adapted to any fishing vessel.

SAFE OPERATION PLAN			
Page 1 of 2			
VESSEL DETAILS			
Name	Registration number	Home port	Fishing licence number
SKIPPER AND CREW DETAILS			
Position	Name	Telephone	Emergency contact
Skipper			
Fisher 1			
Fisher 2			
Etc.			
TRIP DETAILS			
Departure date and time	Departure location	Intended fishing area	Expected trip duration
EMERGENCY CONTACTS			
Police	Search and Rescue	Ambulance	Other (specify)
Phone: Phone:	Phone:	Phone:	
EMERGENCY PROCEDURES			
Not serious	Serious	Emergency	
Breakdown or other problem not requiring assistance	Machinery breakdown or other problem requiring assistance	Accident requiring immediate help (MAYDAY)	

SAFE OPERATION PLAN

Page 1 of 2

PRE-DEPARTURE SAFETY CHECK

Item	To be performed/action required	Confirm Yes/ No
Hull	Inspect hull	
Drain plug	Ensure drain plug is properly inserted	
Engine	Clean and check fuel filter	
	Check spark plugs and replace if necessary	
	Check battery levels and terminals	
	Check all moving parts - lubricate if necessary	
	Check tiller and engine mount	
	Check propeller	
	Check oil level and top up, if necessary	
	Run and test engine	
Boat rope	Secure and stow at the bow	
Fire extinguisher (Class ABC)	Check expiry date	
	Check content level	
	Check pin in place	
First aid kit	Check contents and replace/refill items as necessary	
Bailer	Ensure it is usable	
Tool kit	Check and replace	
Waterproof torch	Check batteries and test	
Tow rope or anchor line	Stow away from working area	
Bilge pump	Test	
Steering cables and pulleys	Test steering	
Life jackets	One for each crew	
VHF radio	Check battery charge and test	
Distress signalling device (flares, rescue laser, etc.)	Ensure "use by" dates are valid	
Anchor	Stowed and in good condition	
2 paddles/oars and rowing crutches (rowlocks)	Stowed and in good condition	
Sail and leeboard	Stowed and in good condition	
Navigation lights	Test	
Fishing gear	Check that all are in place according to the standard list	
Water	Sufficient for the trip + extra	
Food	Sufficient for the trip + extra	
Fuel	Sufficient for the trip + extra	



PRE-DEPARTURE FISHING GEAR CHECK/ INVENTORY		
Item	Quantity	Confirm Yes/ No
Icebox		
Ice		
Bait		
Chum bait		
Gaff		
Hand gloves		
Knives		
Oil stone		
Fish bat or club		
Mechanised reel or wooden hand reel		
Appropriate gear for the fishing methods that will be used		

Appendix 2: Five minutes that can save your life

Some of the emergencies that nearshore fishers may face – and the steps that could be taken to avoid or minimise them – are shown below. Follow these simple steps to ensure your fishing trip does not end in disaster.

EMERGENCY SITUATION	PREVENTION	ACTIONS
 <p data-bbox="197 824 336 853">OUT OF FUEL</p>	<p data-bbox="596 427 884 528">Take adequate fuel to sea. Take more than required for intended distance to travel.</p> 	<p data-bbox="1008 427 1342 528">Radio for assistance. Use alternate propulsion source (e.g. sails, oars).</p> 
 <p data-bbox="197 1176 421 1205">LOST SIGHT OF LAND</p>	<p data-bbox="596 875 852 904">Develop navigation skills.</p> 	<p data-bbox="1008 875 1394 904">Head towards direction you last saw land.</p> 
 <p data-bbox="197 1552 395 1581">VESSEL SWAMPED</p>	<p data-bbox="596 1229 836 1294">Don't overload. Beware of bad weather.</p> 	<p data-bbox="1008 1229 1289 1294">Discard extra cargo or fish. Bail or pump water out.</p> 
 <p data-bbox="197 1944 421 1973">VESSEL INSTABILITY</p>	<p data-bbox="596 1606 884 1671">Load boat correctly. Keep weight low in the boat.</p> 	<p data-bbox="1008 1606 1209 1671">Re-arrange weight. Clear scuppers.</p> 

EMERGENCY SITUATION	PREVENTION	ACTIONS
 <p data-bbox="196 607 379 629">VESSEL LEAKING</p>	<p data-bbox="595 271 898 293">Check boat in port and repair.</p> 	<p data-bbox="1010 271 1329 338">Make temporary repairs at sea. Keep bailing or pumping.</p> 
 <p data-bbox="196 976 427 999">VESSEL OVERLOADED</p>	<p data-bbox="595 658 746 680">Don't overload.</p> 	<p data-bbox="1010 658 1209 680">Remove extra load.</p> 
 <p data-bbox="196 1368 371 1391">ENGINE FAILURE</p>	<p data-bbox="595 1025 850 1093">Service engine regularly. Have spares and tools.</p> 	<p data-bbox="1010 1025 1265 1126">Attempt to repair. Radio for assistance. Use alternate propulsion.</p> 
 <p data-bbox="196 1794 523 1816">SUDDEN CHANGE OF WEATHER</p>	<p data-bbox="595 1415 914 1482">Check weather forecast before going to sea.</p> 	<p data-bbox="1010 1415 1153 1482">Head for port. Heave</p> 

EMERGENCY SITUATION	PREVENTION	ACTIONS
 <p data-bbox="199 629 438 658">GROUNDING ON A REEF</p>	<p data-bbox="598 271 813 338">Keep a good lookout. Know the area.</p> 	<p data-bbox="1013 271 1220 338">Attempt to get off. Radio for assistance.</p> 
 <p data-bbox="199 1048 566 1077">COLLISION WITH ANOTHER VESSEL</p>	<p data-bbox="598 680 813 710">Keep a good lookout.</p> 	<p data-bbox="1013 680 1189 748">Repair damage. Assist each other.</p> 
 <p data-bbox="199 1467 478 1496">LOSS OF STEERING AT SEA</p>	<p data-bbox="598 1099 901 1128">Check steering gear regularly.</p> 	<p data-bbox="1013 1099 1268 1128">Rig a jury rudder system.</p> 
 <p data-bbox="199 1904 502 1933">LOSS OF PROPELLER AT SEA</p>	<p data-bbox="598 1518 853 1547">Check propeller regularly.</p> 	<p data-bbox="1013 1518 1268 1585">Radio for assistance. Use alternate propulsion.</p> 

LIFE JACKETS

1. Put your head through the life jacket.



2. Pass the belt around your waist and tighten it.



3. Jump feet first into the water.



SMALL BOAT SAFETY CHECKLIST

<p>SPARE FUEL</p> 	 <p>ENGINE TOOLS AND SPARES</p>
 <p>ANCHOR AND ROPE</p>	 <p>SEA ANCHOR</p>
 <p>ALTERNATIVE PROPULSION</p>	 <p>COMPASS</p>
<p>FLARES</p>  <p>SIGNALLING DEVICE</p>  <p>MIRROR</p>	 <p>FLOTATION DEVICE</p>  
<p>WATER CONTAINER</p>  <p>WATER</p>	 <p>FOOD AND FISHING TACKLE</p>
 <p>FIRST AID KIT</p>	 <p>PERSONAL LOCATOR BEACON - PLB</p>
 <p>BAILING DEVICE</p> 	 <p>SHADE</p>

Appendix 3. Further reading

SPC has produced a wide range of technical manuals on practical fishing, fish handling and fish identification, some of which are illustrated below. All the documents shown can be found in the SPC Digital Library (<https://www.spc.int/DigitalLibrary/FAME>) or by searching the internet.

Practical fishing manuals

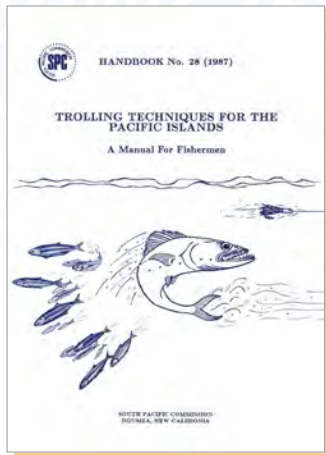

<https://purl.org/spc/digilib/doc/aaupa>

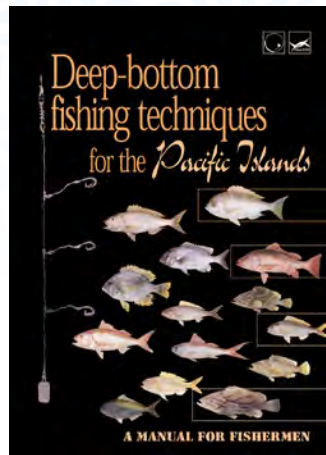

<https://purl.org/spc/digilib/doc/qixcy>

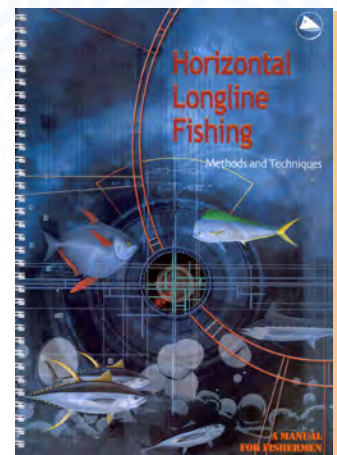

<https://purl.org/spc/digilib/doc/h4h73>

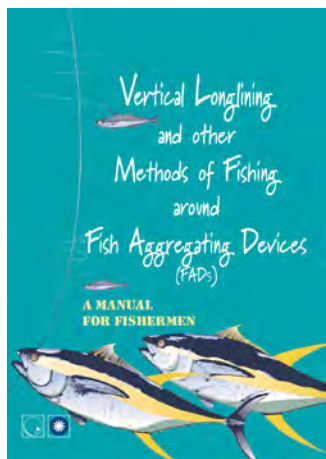

<https://purl.org/spc/digilib/doc/8d3op>



<https://purl.org/spc/digilib/doc/ymkyx>

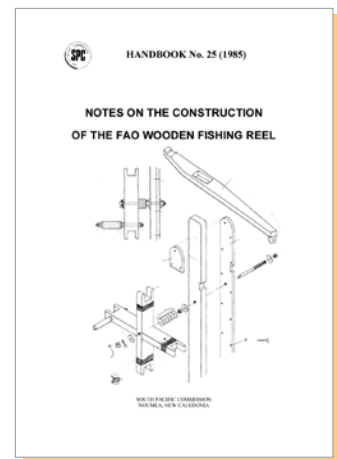

<https://purl.org/spc/digilib/doc/3u43p>

Fish-handling techniques

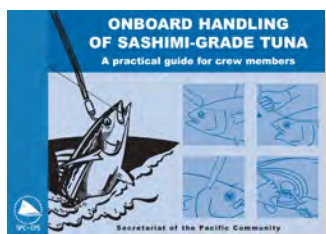

<https://purl.org/spc/digilib/doc/z2ehu>



<https://purl.org/spc/digilib/doc/mq2vr>

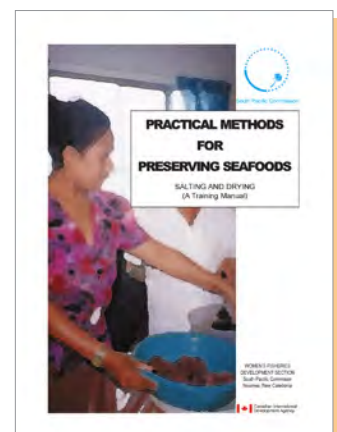

<https://purl.org/spc/digilib/doc/e47kd>

Marine species identification guides



<https://purl.org/spc/digilib/doc/dd7xj>

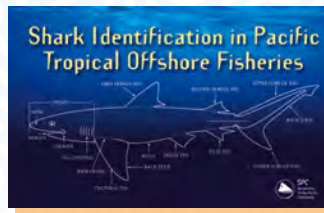

<https://purl.org/spc/digilib/doc/z39av>

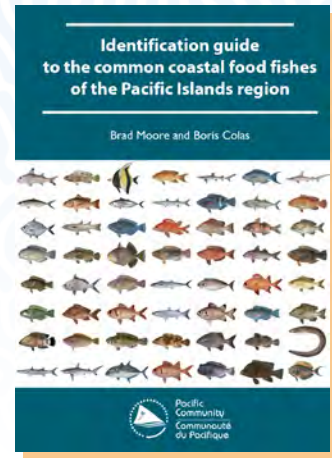

<https://purl.org/spc/digilib/doc/pd9p6>

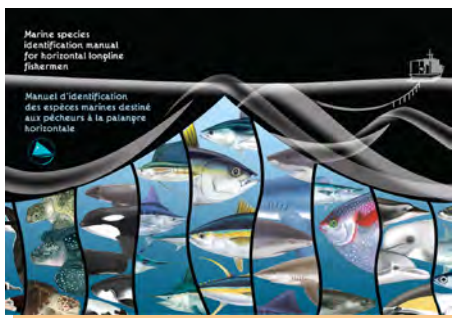

<https://purl.org/spc/digilib/doc/2vwah>



<https://purl.org/spc/digilib/doc/8jhnb>



<https://purl.org/spc/digilib/doc/79zd5>



<https://purl.org/spc/digilib/doc/z8ze9>

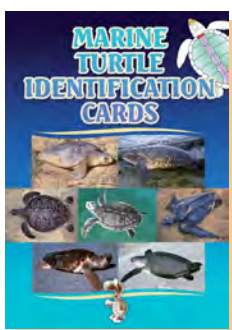

<https://purl.org/spc/digilib/doc/x8xzn>



<https://purl.org/spc/digilib/doc/akmpd>



<https://purl.org/spc/digilib/doc/ugzxs>

The Food and Agriculture Organization of the United Nations (FAO) has also produced a wide range of technical manuals and videos on aspects of practical fishing, fish handling, safety at sea, and engine maintenance. They can be found via the FAO website (<https://www.fao.org>) or by searching the internet. Some of the techniques described in these manuals and videos are also covered in the present manual.

Some manuals and videos produced by FAO



<http://www.fao.org/documents/card/en/c/cc5490en>



<https://www.youtube.com/watch?v=q4Yipy9aSuk>



<https://www.fao.org/documents/card/en/c/cc5862en>



<https://www.youtube.com/watch?v=DQ3WAYiYiLc>



<http://www.fao.org/documents/card/en/c/cc6257en>

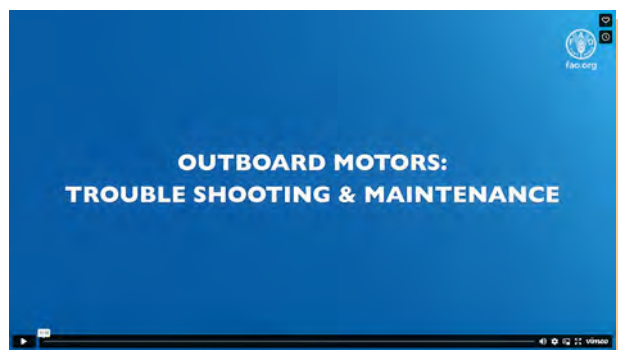

<https://www.youtube.com/watch?v=Gw-5qJnVXck&t=118s>





ISBN 978-982-00-1515-9



9 789820 015159



EUROPEAN UNION



Sweden
Sverige



NEW ZEALAND
FOREIGN AFFAIRS & TRADE
Aid Programme

Australian
Aid 



PEUMP

Pacific-European Union Marine Partnership Programme



Pacific
Community
Communauté
du Pacifique