



Improving Accessibility in Transport

Infrastructure Projects in the Pacific Islands



This report has been prepared by the Pacific Region Infrastructure Facility (PRIF) in conjunction with the Pacific Disability Forum and the Pacific Islands Forum Secretariat. PRIF is a multi-development partner coordination, research and technical assistance facility that supports infrastructure development in the Pacific. The PRIF agencies include: Asian Development Bank (ADB), Department of Foreign Affairs and Trade (Australia), European Investment Bank, European Union, Japan International Cooperation Agency, New Zealand Ministry of Foreign Affairs and Trade, and the World Bank Group.

The report was written by Ms Julie Babinard (The World Bank), Ms Christine McMahon of the PRIF Coordination Office (PCO), and Ms Judy Wee (consultant). The views expressed are those of the authors and do not necessarily reflect the views and policies of ADB, its Board of Governors, or the governments they represent or any of the other PRIF agencies. None of the above parties guarantees the accuracy of the data included in this publication or accepts responsibility for any consequence of their use, though due care has been taken in preparing and reviewing the report.

The use of information contained in this report is encouraged with appropriate acknowledgement. The report may only be reproduced with the permission of PCO.

More information and additional copies of this report can be obtained from:



PACIFIC REGION INFRASTRUCTURE FACILITY

PRIF Coordination Office
c/- Asian Development Bank
Level 20, 45 Clarence Street
Sydney, New South
Wales, Australia, 2000
Tel: +61 2 8270 9444
Email: enquiries@theprif.org
Website: www.theprif.org



Pacific Disability Forum
Ground Floor, Kadavu House
Victoria Parade
Suva, Fiji
Tel: +679 331 2008
Website: www.pacificdisability.org



**PACIFIC ISLANDS
FORUM SECRETARIAT**
Pacific Islands Forum Secretariat
Private Mail Bag, Suva, Fiji
Tel: +679 331 2600
Website: www.forumsec.org

Improving Accessibility in Transport

Infrastructure Projects in the Pacific Islands





Acknowledgements

Acknowledgement is given to the following people and organisations for their participation in this project:

Project Oversight and Coordination

- Ms Julie Babinard, Senior Transport Specialist, The World Bank
- Mr Christopher Bennett, Lead Transport Specialist / Pacific Islands Transport Cluster Leader, The World Bank
- Ms Christine McMahon, Results and Research Manager, PRIF Coordination Office

Project Implementation Committee

- Ms Linda Kaua, Economic Reform Officer, Pacific Islands Forum Secretariat
- Ms Christine McMahon, Results and Research Manager, PRIF Coordination Office
- Mr Setareki Macanawai, Chief Executive Officer, Pacific Disability Forum
- Mr Laisiasa Merumeru, Disability Coordination Officer, Strategic Partnerships and Coordination Program

Project Consulting Firm

- Ms Judy Wee, Founder and Principal Consultant, LevelField Consultants
- Mr Patrick Ang, Partner/Access Consultant, LevelField Consultants

Preparation of Report

- Ms Julie Babinard, Senior Transport Specialist, The World Bank
- Ms Christine McMahon, Results and Research Manager, PRIF Coordination Office
- Ms Judy Wee, Principal Consultant, LevelField Consultants

Organisation of Country Visits and Audits

- Ms Tai'atu Atata'ata, Development Coordination Officer, ADB-WB Joint Development Coordination Office, Honiara, Solomon Islands
- Mr Paula Baleilevuka, Infrastructure Specialist, Asian Development Bank
- Mr Pivithuru Indrawansa, Senior Project Officer (Infrastructure), Asian Development Bank
- Mr Luke Kiddle, First Secretary – Development, New Zealand High Commission, Solomon Islands
- Ms Eileen Kwalea, Development Programme Coordinator, New Zealand High Commission, Solomon Islands
- Mr Michael Schruer, Principal Development Manager (Infrastructure), NZMFAT

Participation in Focus Groups Interviews, and Meetings

- See list in Appendix A

Provision of Supporting Documentation for the Project

- Mr Simone Bula, Information Officer, Pacific Disability Forum
- Mr Lloyd Wright, Senior Transport Specialist, Asian Development Bank

Review within the PRIF Agencies

- PRIF Management Committee
- Mr Sanjivi Rajasingham, Director, PRIF Coordination Office

Production of Report

- Ms Vinoka Hewage, Project Officer, PCO
- Mr Jack Whelan, Secretariat Manager, PCO



Glossary

Accessible Built Environment	An environment in which everyone can easily and safely enter, move through its vicinity, and use the facilities.
Anthropometrics	The measurement of size, shape and proportions of the human body.
Barrier Free Accessibility	Refers to the basic accessibility requirements needed to ensure a piece of infrastructure or development is usable by people with disabilities ensuring/supporting their ability to move around within their community and beyond.
Disability	An evolving concept. No longer a definition used to describe people in terms of a condition they have or experience. Rather, the concept is now more about the interaction (or mismatch) between people with impairments and the physical environment or attitudinal barriers they encounter that can hinder their full participation in society equally with others.
Disability Groups	An assemblage of persons with disabilities or organisations supporting individuals with disabilities.
Disability-Inclusive Development	An approach to development programs and projects which actively identifies and provides support in addressing barriers that discourage or exclude people with disabilities from participating in and getting benefit from development efforts.
Disabled Persons Organisation	An organisation acting as the representative voice for people with disabilities.
Last Mile Connectivity	Refers to the walking distance between public transport points (e.g. bus stop) and a person's final destination.
Person with a Disability	Includes those who have long-term physical, mental, intellectual, or sensory impairments which, in interaction with barriers, may hinder their full participation in society on an equal basis with others.
Q-Poles	Deriving from the word 'queue', these are poles that are placed to assist people in forming queues to obtain services.
Universal Access or Universal Design	Ensuring equitable access by eliminating barriers in the built environment to improve the mobility and participation of everyone, particularly people with disabilities and the elderly. The concept guides the design of all products and the built environment so these are usable to the greatest possible extent by everyone, regardless of their age, ability, or current status in life.



Key Acronyms

ADB	Asian Development Bank
ATM	Automatic Teller Machine
BFA	Barrier Free Accessibility
CEO	Chief Executive Officer
CBR	Community-Based Rehabilitation
CNMI	Commonwealth of the Northern Mariana Islands
DFAT	Department of Foreign Affairs and Trade (Australia)
DPL	Disabled Passenger Lift
DPOs	Disabled Persons' Organisations
EIB	European Investment Bank
EU	European Union
ICT	Information and Communications Technology
FSM	Federated States of Micronesia
JICA	Japan International Cooperation Agency
KRRP	Kiribati Road Rehabilitation Project
MBIE	Ministry of Business, Innovation and Employment (New Zealand)
MPWU	Ministry of Public Works and Utilities (Kiribati)
NATA	Naunau O' E' Alamaite, Tonga Association
NDPO	Nauru Disabled Persons Organisation
NOLA	Nuanua O Le Alofa (Samoa)
NTAA	Niue Tolomaki Auloa Association
NZMFAT	New Zealand Ministry of Foreign Affairs and Trade
PAIP	Pacific Aviation Investment Program
PCO	PRIF Coordination Office
PDF	Pacific Disability Forum
PICs	Pacific Island Countries
PIFS	Pacific Islands Forum Secretariat
PLM	People with Limited Mobility
PNG	Papua New Guinea
PRIF	Pacific Region Infrastructure Facility
PWDs	People with Disabilities
PWDSI	People with Disabilities, Solomon Islands
RMI	Republic of the Marshall Islands
SIRIP	Solomon Islands Road Improvement Project
UD	Universal Design
UNCRPD	United Nations Convention on the Rights of People with Disabilities
UNESCO	United Nations Educational, Scientific and Cultural Organization
WBG	World Bank Group
WHO	World Health Organization



Table of Contents

Executive Summary	i
Section 1 - Background and Context in Pacific Islands Region	1
Chapter 1. Introduction	1
Section 1 – Background and Context in Pacific islands region	1
Section 2 – Accessibility Guidelines and Screening Tools.....	2
Section 3 – Recommendations and Appendices.....	2
Chapter 2. Accessibility - Key Concepts	3
Chapter 3. Legal and Policy Framework in Pacific Islands Region	6
International Policy Framework.....	6
Regional Policy and Legislation.....	7
Accessibility Codes and Guidelines	8
Disabled Persons Organisations.....	8
Chapter 4. Policies, Strategies and Guidelines in PRIF Agencies	9
Introduction.....	9
Policies, Strategies and Guidelines.....	9
Asian Development Bank.....	9
Australian Aid.....	9
European Investment Bank.....	10
European Union	10
Japan International Cooperation Agency.....	11
New Zealand Government	11
The World Bank Group.....	12
Summary of Features in Guidelines	12
Chapter 5. Audit of PRIF Agency Projects in Five Countries	14
Introduction.....	14
General Observations about Accessibility in the Five Countries	14
Audit Findings.....	14
Air Transportation.....	14
Maritime Transportation	16
Road Transportation	17
Further Details about the Countries	21
Kiribati.....	21
Samoa	21
Solomon Islands.....	22
Tonga.....	23
Tuvalu	23



Table of Contents continued

Section 2 - Accessibility Guidelines and Screening Tool25

Chapter 6. Guidelines for Improved Accessibility25

Introduction.....	25
Anthropometrics of People and Mobility Aids.....	25
Aviation and Maritime Infrastructure	29
Terminal Buildings	29
Boarding and 'Drop off'/'Pick Up' Points	29
Trolley Parking Bays.....	30
Entrance to Terminal Buildings.....	30
Wayfinding, Signage and Audio Announcements	30
Check-in Facilities and Interactive Kiosks	31
Interior Seating, Resting and Waiting Areas.....	32
Washroom Facilities	32
Immigration and Customs Areas	35
Boarding and Alighting from Aircraft	35
Embarking and Disembarking from Vessels.....	36
Baggage Claim Area.....	37
Road Infrastructure	37
Carriageway Layout.....	37
Kerb Ramps.....	38
Footpaths.....	40
Crossings.....	41
Street Furniture.....	41
Reserved and Designated Parking Lots.....	42
Bus Stops and Taxi Stands.....	43
Seamless Connectivity.....	45

Chapter 7. Accessibility Screening Tool46

Introduction.....	46
How to Complete the Screening Tool Checklists.....	49
Example of a Completed Screening Tool Checklist.....	50

Section 3 - Conclusions, Recommendations and Appendices53

Chapter 8. Conclusions and Recommendations53

Appendix A – list of participants in the consultation process.....	A-1
Appendix B – list of DPOs in the Pacific.....	B-1
Appendix C – details of the PRIF agency projects included in the audit in five countries.....	C-1
Appendix D – accessibility screening tool.....	D-1
Appendix E – other resource materials.....	E-1



List of Tables

Table 1. Participation in UNCRPD by Pacific Island Countries.....	6
Table 2. Pacific Islands Region: Legislation and Policies on Disabilities	7
Table 3. PRIF Agency Guidelines on Accessibility.....	13
Table 4. Accessibility Features in Audited Aviation Infrastructure	15
Table 5. Accessibility Features in Audited Maritime Infrastructure.....	16
Table 6. Accessibility Features in Audited Road Infrastructure.....	18
Table 7. Template of Screening Tool Checklist: Road and Pedestrian Infrastructure	47
Table 8. Completed Example of Screening Tool Checklist.....	51

List of Figures

Figure 1. Comfortable Widths Between Pedestrians.....	26
Figure 2. Typical Wheelchair Dimensions.....	27
Figure 3. Forward Reach from a Wheelchair	28
Figure 4. Side Reach from a Wheelchair.....	28
Figure 5. Layout of Accessible Washroom.....	32
Figure 6. Wheelchair Transfer – Side, Front and Diagonal Approaches.....	34
Figure 7. Typical Dual Carriageway Road.....	38
Figure 8. Kerb Ramp with Flared Sides.....	38
Figure 9. Design of In-line Ramp	39
Figure 10. Tactile Indicators at Kerb Ramp.....	39
Figure 11. Minimum Allowable Camber for Footpaths and Ramps.....	40
Figure 12. Example of Layout for Street Furniture.....	42
Figure 13. Path Linking Accessible Carpark and Building	43
Figure 14. Layout for a Taxi Shelter	44
Figure 15. Layout for a Bus Bay and Shelter.....	44



Executive Summary

This document has been developed as part of a research study to assist the project partners – Pacific Disability Forum, Pacific Islands Forum Secretariat and Pacific Region Infrastructure Facility (PRIF) – in their efforts to enhance accessibility in the transport sector and built environment in Pacific countries. The project was initiated by the World Bank through the PRIF Transport Sector Working Group. The document comprises three sections – an assessment of the situation in the Pacific islands region in regard to accessibility; technical guidelines and screening tools for assessing or auditing accessibility features in transport infrastructure; and recommendations and other supporting material. It is designed for two main audiences in the PRIF agencies – policy and decision-makers who may need to be better informed about the general issues in improving accessibility, and project managers, planners, engineers and contractors who need to understand technical issues related to design and construction of accessible infrastructure. However, it may also be useful to Pacific governments and to organisations working in support of people with disabilities. Hence, the involvement of the Pacific Disability Forum and Pacific Islands Forum Secretariat has been not only as organisers and informants, but also as recipients of the final product.

The research study consisted of four main components:

- background research on legal and policy frameworks in the Pacific and among the PRIF agencies
- audit of accessibility features in 11 projects developed through funding by PRIF agencies (in Kiribati, Samoa, Solomon Islands, Tonga, and Tuvalu)
- consultation with a range of stakeholders including the project partners, Pacific governments and associations for people with disabilities, and
- preparation of this document and other associated papers and presentations.

Although the study concerns all modes of transport – aviation, road and maritime – a key problem identified is the lack of connectivity for pedestrians moving about in their communities. In many Pacific countries, footpaths do not offer a comprehensive network and they are generally built without reference to recognised standards for accessibility. Furthermore, trees, parked vehicles, lamp posts, rubbish bins and other street furniture can obstruct footpaths, making it difficult for people with disabilities to move around in the community. Consequently, people with disabilities tend to stay at home and are rarely seen outside.

Changing this situation – and also addressing deficits in aviation and maritime transport – requires a combination of three elements: *Engineering, Education, and Enforcement* (the three ‘E’s). Only with these in place can improved accessibility be both seamless and sustainable. *Engineering* deals with developing and regularly updating accessibility standards and guidelines to ensure they remain current and are incorporated into design work for infrastructure projects. *Education* concerns the training required for Pacific authorities, disabled persons’ organisations and among development partners to understand the *how* and *why* of standards and guidelines on accessibility. Another element of this relates to increasing community awareness about people with disabilities and their needs. *Enforcement* requires commitment by governments to ensuring the appropriate legislation and regulations are in place, that it is clear who has responsibility for enforcement of the standards, and that assessments and audits are conducted. By adopting appropriate standards into engineering designs and construction work, development partners are showing leadership and avoiding a situation where retro-fitting is required. They also need to give consideration to how maintenance will be planned for, funded and undertaken, including any particular requirements associated with accessibility features.



Given it will take time to introduce accessible infrastructure, short term solutions are also needed. The country audits and consultations that were done as part of this research study suggest that a road transport service offering point-to-point connectivity (on-demand or scheduled) could greatly improve the lives of people with disabilities. The scope, modality and cost of this facility and the demand for its use would need to be assessed in each country prior to its introduction.

The document presents a range of information, including:

- key concepts about accessibility – including Barrier Free Accessibility and Universal Design
- the legal framework and relevant conventions
- policies and existing guidelines among the PRIF agencies
- the accessibility context in each of the five countries that were visited as part of the study
- key design features for improving accessibility
- screening tools to use in rating the level of accessibility in proposed project designs, construction work prior to its completion, or in auditing existing infrastructure that may then be subject to modification work, and
- some recommendations for governments, organisations representing people with disabilities, and development partners in regard to actively changing the current situation.

The recommendations from this study are that:

- all Pacific Island Countries (PICs) sign or ratify the United Nations Convention on the Rights of People with Disabilities as a first step towards recognising the need to promote inclusion of people with disabilities
- Pacific island governments develop and implement basic Accessibility Codes and work towards Barrier Free Accessibility (BFA) across transport networks and in the built environment, including seamless connectivity
- Disabled Persons' Organisations (DPOs) should take a lead in fighting stigma by organising awareness campaigns to support better integration of people with disabilities into society, working with the authorities to promote understanding and application of the Accessibility Codes, coordinating with various authorities to plan and implement an accessible built environment and transport network, and organising activities for people with disabilities that enable them to be more engaged in the community
- PRIF agencies ensure that all new infrastructure and developments are designed and built to be accessible and in accordance with national legislation and policy, and
- PDF and PIFS consider establishing a task force in each country that includes relevant authorities and stakeholders to look into the planning, implementation, and maintenance of accessible infrastructure to accelerate the provision of a barrier free environment and associated capacity building requirements.

Chapter 1. Introduction

This document is the result of a research study funded by the Pacific Region Infrastructure Facility (PRIF) and supported by the Pacific Disability Forum (PDF) and the Pacific Islands Forum Secretariat (PIFS). The study was designed to assess the current status of public transport infrastructure developed by PRIF agencies and to support the implementation of the policies and guidelines of PRIF agencies by providing current information on about globally-recognised standards and how they can be applied in the Pacific context. The countries of interest are those where PRIF is active¹, though sometimes information is included from other countries and territories where this may be useful.

Originally, it was intended that the study would consider other types of infrastructure apart from those related to the transport sector (e.g. in the energy sector or in water and sanitation), but this proved difficult to accomplish, so this document is focused on the three transport sub-sectors (i.e. aviation, maritime and roads). However, given the importance of having a seamless and accessible transition from one point to another across the transport network and throughout the community, it was decided to include information about access to and within buildings, as well as the infrastructure used to transport people to those buildings.

The research study consisted of four main components:

- background research on legal and policy frameworks in the Pacific and among the PRIF agencies
- audit of accessibility features in 11 projects developed through funding by PRIF agencies (in Kiribati, Samoa, Solomon Islands, Tonga, and Tuvalu)
- consultation with a range of stakeholders including the project partners, Pacific governments and associations for people with disabilities, and
- preparation of this document and other associated papers and presentations.

The Guidelines section presents information that can be used by developers and engineers in the design and construction of infrastructure. They may also be a useful reference for governments in preparing Accessibility Codes and Building Regulations and for Disabled Persons Organisations (DPOs) in their advocacy work, awareness-raising activities and training. Although the Guidelines are based on audits in only five countries, they are expected to be useful in other countries as well. In addition, while the focus of the report is on people with disabilities, many of the benefits will also apply to the elderly and infirm.

The structure of the report is as follows:

Section 1 - Background and Context in Pacific islands region

- this Introduction
- key concepts are discussed in Chapter 2 – including Barrier-Free Accessibility and Universal Design
- the legal and policy framework is presented in Chapter 3 – including material on the United Nations Convention on the Rights of People with Disabilities (UNCRPD)
- policies, strategies and guidelines in PRIF agencies are summarised in Chapter 4
- a summary of issues noted in the PRIF projects in five Pacific countries is provided in Chapter 5

¹ i.e. Cook Islands, Federated States of Micronesia (FSM), Fiji, Kiribati, Palau, Nauru, Niue, Republic of the Marshall Islands (RMI), Samoa, Solomon Islands, Tonga, Tuvalu, Vanuatu.



Section 2 - Accessibility Guidelines and Screening Tools

- the Accessibility Guidelines are in Chapter 6
- the Screening Tools are in Chapter 7

Section 3 - Recommendations and Appendices

- recommendations are in Chapter 8, and
- there are several Appendices, comprising:
 - Appendix A – list of participants in the consultation process
 - Appendix B – list of DPOs in the Pacific
 - Appendix C – details of the PRIF agency projects included in the audit in five countries
 - Appendix D – accessibility screening tool, and
 - Appendix E – other resource materials.

It should be noted that suitable examples to illustrate several concepts in this report were not available in the Pacific Island countries that were visited. As a result, many of the photographs in this report show infrastructure features in Australia and elsewhere. Equivalent facilities in the Pacific Islands will need to be adapted to local considerations, and national building codes.. Some of the photographs show commercially-available products. These are used for illustration purposes only and do not represent endorsement of any particular brands.



Chapter 2. Accessibility - Key Concepts

An accessible built environment and public transport system enhances the mobility of persons with disabilities and promotes inclusion and independence. The World Health Organization (WHO) estimates that over one billion people (about 15% of the world's population) have some form of disability and up to 190 million adults have significant difficulties functioning². While there is no demographic data from census results or national surveys in the Pacific Island Countries (PICs), there is evidence that people with disabilities are more likely to be socially and economically excluded. For example, while transport is an essential element of independent living for most people, in the Pacific the public transport systems are not accessible to persons with disabilities, hindering their access to economic opportunities as well as education and health services. This also applies to other user groups such as the elderly, parents with babies in prams, and people with temporary injuries.

This study has adopted two important concepts i.e. Barrier-Free Accessibility and Universal Design.

Barrier-Free Accessibility refers to the basic or minimum requirements that are needed to ensure a piece of infrastructure is usable by people with disabilities or, more broadly, that people with disabilities can move about in the built environment. While this does not necessarily mean that everyone is able to have active and full participation, it is a good contribution towards making this possible.

Universal Design is a higher standard than Barrier-Free Accessibility and generally needs more consideration to achieve what is required. It ensures that everyone in the community and all visitors can move seamlessly from their home (or other accommodation) into the community (and beyond) using various modes of transportation (i.e. air, sea and road) that are linked. It involves being able to move along footpaths, use public and private transport, and be in position to interact with other people and patronise community facilities in order to attend to day-to-day needs and contribute to the community and society as a whole.

The term 'Universal Design' was coined by the architect Ronald L. Mace in 1997 to describe the concept of designing all products and the built environment to be aesthetic and usable to the greatest extent possible by everyone, regardless of their age, ability, or status in life. The Seven Principles of Universal Design that Mace and his colleagues developed are as follows³:

- *Equitable Use* – design is useful and marketable to people with diverse abilities
- *Flexibility in Use* – design accommodates a wide range of individual preferences and abilities
- *Simple and Intuitive Use* – design is easy to understand, regardless of the user's experience, knowledge, language skills, or current concentration level
- *Perceptible Information* – design communicates necessary information effectively to the user, regardless of ambient conditions or the user's sensory abilities
- *Tolerance for Error* – design minimises hazards and the adverse consequences of accidental or unintended actions.
- *Low Physical Effort* – design can be used efficiently and comfortably, with a minimum of fatigue
- *Size, Space for Approach and Use* – appropriate size and space is provided for approach, reach, manipulation, and use regardless of user's body size, posture, or mobility.

² World Health Organization. (2016). *Disability and health: Fact sheet*. <http://www.who.int/mediacentre/factsheets/fs352/en/>. Access Date: 13th March 2016.

³ The Center for Universal Design. (1997). *The principles of universal design*. https://www.ncsu.edu/ncsu/design/cud/about_ud/udprinciplestext.htm. Access Date: 7th January 2016.



Universal Design is an evolving concept, so terms and concepts have developed over time. For example, *Inclusive Design* and *Design for All* are concepts that now have a range of different definitions and interpretations, including the following:

- a philosophy about making things more accessible, convenient, safer and inclusive, developed in response to the diversity of human groups/populations, their needs and abilities⁴
- a process that enables and empowers populations by improving human performance, health and wellbeing, and the level of social participation⁵
- design of everything for everyone – a framework for the design of places, things, policy, information and communication so that the widest range of people can operate in the widest range of contexts without the need for special or separate design⁶, and
- aims to foster equality, inclusion and sustainability so that everyone has the opportunity to participate in every aspect of society including moving around in the built environment, using everyday objects, accessing services, participating in culture and obtaining information they need⁷.

“Good design enables
Bad design disables”

(Paul Hogan, President Emeritus, European Institute for Design and Disability)

Taken from a presentation by P. Kercher, “Design for All: Changing the World by Design”, delivered at the European Conference on Protecting and Promoting the Rights of Persons with Disabilities in Europe: Towards Full Participation, Inclusion and Empowerment, Strasbourg, 30 October 2008⁸

The following are some simple examples of Universal Design:

- seamless ground level entrances without a step or stairs
- features are detectable with colour-contrasting surface textures to act as guiding paths to essential services
- wide doorways, passageways and turning spaces at doorways and dead-ends
- clear and accessible space for approach and use e.g. at counters
- lever handles for opening doors and faucets instead of twisting knobs
- operable part requiring only single-hand movement with closed fist (without pinching and twisting movements)

⁴ Center for Inclusive Design and Environmental Access. (2009). *What is universal design?* <http://udeworld.com/>. Access Date: 7th January 2016.

⁵ Steinfeld, E. & Maisei, J. (2012). *Universal design: Creating inclusive environments*. Hoboken: Wiley.

⁶ Institute for Human Centered Design. (2015). *Universal design: Principles*. <http://humancentereddesign.org/universal-design>. Access Date: 7th January 2016.

⁷ European Design for All e-Accessibility Network. (undated). *Design for all: Glossary of terms*. <http://www.edean.org/index.php?filters=f57>. Access Date: 7th January 2016.

⁸ http://www.google.com.au/url?sa=t&rct=j&q=&esrc=s&source=web&cd=8&ved=0ahUKEwiPz72u45bKAhVDkZQKHS8CAIcQFgg8MAc&url=http%3A%2F%2Fwww.coe.int%2F%2FDIC%2FFiles%2FSource%2FDisability_18.ppt&usq=AFQjCNHwD5mlzbsdpp-r-wqbO3e1sWxg. Access Date: 7 January 2016.



- buttons and other controls are easily distinguished by touch and colour contrast
- lighting is sufficiently bright but without glare
- meaningful and easy to understand pictograms and icons are placed at an appropriate height (incorporating text and braille), and
- clear lines of sight.

To illustrate the difference between *Barrier-Free Accessibility* and *Universal Design*, it is useful to consider the example of a flight of stairs leading into a building.

A *Barrier-Free Design* would consider the construction of a slope ramp alongside or instead of the steps in order to provide an accessible entrance. However, while a ramp enables wheelchair users to gain vertical access, sometimes the gradient is steep and not all wheelchair users are able to manage ramps independently. *Universal Design*, on the other hand, would consider the height difference at design stage, ideally achieving a levelled entry for all users without the need for either steps or ramps.

Clearly, achieving either Barrier-Free Accessibility or Universal Design needs careful thought in design and execution. This requires commitment from various parties, particularly in governments, and sufficient forward planning and budget (whether it will be for new infrastructure or modifications to existing infrastructure and facilities). Therefore, in many Pacific countries, the process is likely to be one of achieving Barrier-Free Accessibility for existing infrastructure, followed in the future with moves towards Universal Design. In that context, there is a need to prioritise work and to be practical. For example, due to space and funding constraints, it may not be feasible to make every car park lot and washroom large enough to accommodate people with disabilities. In such instances, it is recommended to adopt as much Universal Design as possible.

Chapter 3. Legal and Policy Framework in Pacific Islands Region

International Policy Framework

To date, the most important international agreement on disability policy is the UNCRPD which came into force in May 2008. This has now been signed by 158 countries and ratified by 103. In the Pacific islands region, 12 countries and territories have either signed or ratified the Convention. RMI is the latest country from the region to have ratified the Convention in March 2015 (Table 1).

Table 1. Participation in UNCRPD by Pacific Island Countries

Country	Convention Signature Date	Protocol Signature Date	Convention Ratification Date	Protocol Ratification Date
American Samoa				
Commonwealth of the Northern Mariana Islands (CNMI)				
Cook Islands			8 May 2009	8 May 2009
FSM				
Fiji	2 June 2010	2 June 2010		
Kiribati			27 September 2013	
Palau	20 September 2011		11 June 2013	11 June 2013
Papua New Guinea (PNG)	2 June 2011		26 September 2013	
Nauru			27 June 2012	
New Caledonia				
Niue				
RMI			17 March 2015	
Samoa	24 September 2014			
Solomon Islands	23 September 2008	24 September 2009		
Tonga	15 November 2007			
Tuvalu			18 December 2013	
Vanuatu	17 May 2007		23 October 2008	

(Based on information from United Nations Treaty Collection)⁹

⁹ https://treaties.un.org/Pages/ViewDetails.aspx?src=TREATY&mtdsg_no=IV-15&chapter=4&lang=en and https://treaties.un.org/Pages/ViewDetails.aspx?src=TREATY&mtdsg_no=IV-15-a&chapter=4&lang=en, Access Date: 24 March 2016.

Regional Policy and Legislation

There is a *Regional Review on Disability Policy and Legislation* (http://www.forumsec.org.fj/resources/uploads/attachments/documents/Regional_Doc_on_Review_of_policy_and_legislation_on_Disability.pdf). National legislation and policies also exist that promote equality and accessibility. These are shown in Table 2.

Table 2. Pacific Islands Region: Legislation and Policies on Disabilities

Country	Legislation on Disability and Access	Policies on Disability and Access
American Samoa		
CNMI		
Cook Islands	<u>Cook Islands Disability Act</u> ¹⁰	National Policy on Disability (2003) National Disability Action Plan (2003)
FSM		National Policy on Disability (2009 – 2016)
Fiji	<u>Fiji National Council for Disabled Persons (FNCDP) Act (1994)</u> ¹¹	Fiji National Policy on Persons Living with Disabilities (2008-2018) ¹²
Kiribati		
Nauru		
New Caledonia		Policy for Persons with Disabilities (2009) Policy in Favour of Persons with Disabilities and for Persons Experiencing Loss of Autonomy (2009) Disability Charter in New Caledonia (2007)
Niue		National Policy on Disability (2009-2017) National Action Plan on Disability (2012-2015)
Palau	<u>Disability Stipend Law (2011)</u>	National Policy on Disability (2011)
PNG		National Policy on Disability (2009)
RMI	<u>State Plan of the Individuals with Disabilities Education Act (1993)</u> <u>Ministry of Education Act (1991)</u>	Special Education Policy and Procedure (1992)
Samoa		National Policy on Persons with Disability (2009)
Solomon Islands		National Policy on Persons with Disability (2005-2010) ¹³
Tonga		
Tuvalu		
Vanuatu		National Disability Policy and Action Plan (2008-2015)

¹⁰ http://www.paclii.org/ck/legis/num_act/da2008121/

¹¹ http://www.fnmdp.org/docs/FNCDP_Act1994.pdf

¹² http://www.fnmdp.org/docs/2008-18_NationalDisabilityPolicy.pdf

¹³ <https://www.mindbank.info/item/1563>



Accessibility Codes and Guidelines

In most of the countries visited as part of this study, there was neither a Code on Accessibility nor Guidelines. Where there is something, it is mostly in respect to building construction rather than other forms of infrastructure, making it relevant to terminal buildings developed for the aviation and maritime sub-sectors and also for seamless entry to buildings from road infrastructure that may be developed in projects. Comments follow on three Pacific countries, as general examples.

Fiji has a *National Building Code (August 1990)* that includes requirements for people with disabilities¹⁴. In Section ND – *Access and Egress*, the code calls for ‘Access for People with Disabilities’ and clause ND3 provides specifications for building entrances, indicating that reasonable provision must be made in the design of a building for access by people with disabilities. While the *Building Code* does not provide all the necessary details and it is now over 25 years since its release, it does refer readers to the Australian and New Zealand *Building Codes*. For example: under ND3.3(c), it indicates that the parts of a building that must be accessible include finishes and fittings, passageways, ramps, step or kerb ramps, passenger lifts, signs, doorways and other parts of the building to comply with the relevant provisions of AS 1428.1, or NZS 4121 and NZS 4122. Fiji also has a *Procurement Code* which defines the process of procurement in Fiji. Although it is not currently included in this *Code*, Governments can offer tax incentives for the inclusion of accessibility features in infrastructure projects or related accessibility services.

Samoa has a *Disability Guideline – Samoa* (dated 22 Sept. 2013)¹⁵. This provides information for government authorities, public and private developers, architects and property owners about how to improve accessibility in the built environment. In future, these Guidelines could also include information about how the dimensions are derived and the benefits of the layouts for people with disabilities. This would improve clarity and help developers and architects to understand the requirements and ensure correct implementation. A key challenge is to incorporate these Guidelines as mandatory requirements in the *National Building Code*, not only in Samoa but across the Pacific islands region.

In Tonga, the *Building Code 2007* is a 17 page document with a procedural plan for building plan and submission. It is a relatively brief document and does not directly address the need for accessibility for people with disabilities. However, it refers users to the *Building Code of Australia 2004* which does have these provisions.

Disabled Persons Organisations

DPOs have both an advocacy and practical role in regard to the implementation of legislation and policy for people with disabilities. A list of DPOs and contact details is in Appendix B. The PDF, through its website (<http://www.pacificdisability.org>), provides a good overview of past and planned activities of DPOs working in the Pacific islands region.

As is the case in many developing countries, policy implementation remains low in PICs, primarily due to lack of knowledge, awareness and resources on accessibility issues. Yet, while concepts such as Universal Design provide a good analytical framework for addressing accessibility issues, solutions at the country level often need to be found in tailored and cost efficient applications, reflecting the local realities and capacity of developing countries. This is a key role for DPOs. They also provide practical support and organise various activities for people with disabilities.

¹⁴ Copies can be obtained through the Government Printer or Bookstore (<http://www.engineersfiji.org.fj/resources/pdfs/national%20building%20code.pdf>).

¹⁵ Not available online.



Chapter 4. Policies, Strategies and Guidelines in PRIF Agencies

Introduction

A number of the PRIF agencies have policies, strategies and/or guidelines on disability that summarise their position and assist staff in managing programs and projects in the international development context. Others have conducted reviews and noted the need for more support in this area. This section of the report summarises this material, though the full detail requires reference to the documents themselves.

Policies, Strategies and Guidelines

Asian Development Bank

The Asian Development Bank (ADB) does not have a disability policy, though it is included in ADB's Social Protection Index for Asia and the Pacific¹⁶. This notes that disability programs total only 3% of investment in social assistance in Asia and the Pacific, though it is relatively high in some countries including Nauru. It also indicates that Palau, RMI, Samoa and Vanuatu provide pensions for people with disabilities, categorised as social insurance. However, ADB notes the need for 'substantial improvement' in this area.

In the transport sector, ADB is in the process of preparing *Guidelines on Universal Access*. These guidelines are designed to encourage full access for all in every transport initiative from ADB. They give a general overview on design and application as well as providing a benchmark for the creation of universally accessible transportation systems in both urban and rural environments. The guidelines cover vehicles and their associated boarding equipment, including taxis, intercity rail, buses and maritime transport. Journey planning information systems, fare collection and stops and terminals are also discussed.

Australian Aid

Australia is a party to the *UNCRPD*. The Department of Foreign Affairs and Trade (DFAT) has a policy in support of disability-inclusive development. Its strategy document, *Development for All 2015-2020: Strategy for Strengthening Disability-Inclusive Development in Australia's Aid Program*, aims to promote improved quality of life for people with disabilities who live in developing countries. The strategy outlines a twin-track approach:

- developing and implementing disability-inclusive programs through mainstreaming efforts, and
- targeting people with disabilities in some of its development initiatives¹⁷.

Importantly, the Australian Government is committed to ensuring an active role for DPOs and people with disabilities both in policy development and project implementation – '*nothing about us without us*'¹⁸). It emphasises the importance of having a strong evidence base as a foundation for its work (including both sex and disability disaggregated data) and it notes the multiple disadvantages of women and girls with disabilities. In addition, the strategy provides examples of enabling infrastructure including allocation of disability-specific budgets in Timor-Leste and construction of accessibility ramps in more than 90% of water system projects in 2013¹⁹.

¹⁶ Asian Development Bank. (2013). *The Social Protection Index: Assessing Results for Asia and the Pacific*. <http://www.adb.org/sites/default/files/publication/30293/social-protection-index.pdf>, Manila, ADB.

¹⁷ Department of Foreign Affairs and Trade. (2015). *Development for All 2015-2020: Strategy for Strengthening Disability-Inclusive Development in Australia's Aid Program*. <http://dfat.gov.au/about-us/publications/Documents/development-for-all-2015-2020.pdf>, Canberra: Australian Government, p.8.

¹⁸ Department of Foreign Affairs and Trade, op cit, p.10.

¹⁹ Department of Foreign Affairs and Trade, op cit, p.19.



As a companion to its strategy document, DFAT has also prepared *Accessibility Design Guidelines* to mark a change in the way its infrastructure is designed and delivered²⁰. The guide consists of 2 parts. Part A is focused on the importance of including people with disabilities in Australia's aid program, why disability inclusion is integral to sustainable development, and what Universal Design means in the context of the aid management cycle. Part B contains several annexes which provide practical guidance across a range of sectors where Australia's aid programs are involved. This includes the built environment, education, energy, housing, information and communications technology (ICT), transport, and water and sanitation. The Guide sets out how to apply Universal Design measures to support development and includes basic checklists, diagrams and examples to help practitioners integrate universal design principles into different thematic areas.

European Investment Bank

The European Investment Bank (EIB) does not have a published policy on disability issues in its international program. Instead, it generally adopts either the approach being used by the European Union or the policies in place in the organisation or country where it is providing support. For example, in its Transport Lending Policy, reference to the importance of improved accessibility (including for people with disabilities) is mentioned in regard to both road and rail infrastructure projects²¹.

European Union

The European Union is a party to the UNCRPD. Its Disability Strategy 2010-2020 takes a rights-based approach to the position of people with disabilities and is considered complementary to the UNCRPD²². The Strategy seeks to promote the rights of people with disabilities, including in development programs and humanitarian aid. It covers governance, thematic measures (including sectoral dimensions), and cross-cutting issues. There are eight main areas for action, including accessibility, participation, equality, employment, education and training, social protection, health and external action – each area having associated objectives. Undertakings include providing support for national efforts in partner countries in regard to the UNCRPD, assisting in institutional strengthening of DPOs, and ensuring that infrastructure financed through development projects meets the accessibility needs of people with disabilities²³.

For its development cooperation programs, there are several guidance notes on *Disability and Development*²⁴ and *Disability-Inclusive Development Cooperation*²⁵. The European Union has a twin-track approach (as also followed by the Australian Government) and it notes the need to systematically incorporate this issue in policy dialogue with partner governments to foster its inclusion in the political agenda of the country. Other key points include:

- emphasising the importance of country-based analysis of the situation of people with disabilities and the inclusion of this in country poverty assessments, country strategy papers and indicative programs
- participating in and promoting the value of multi-stakeholder partnerships
- supporting Universal Design principles, wherever feasible

²⁰ *Accessibility Design Guide: Universal Design Principles for Australia's Aid Program*, January 2013 - <http://dfat.gov.au/about-us/publications/Documents/accessibility-design-guide.pdf>.

²¹ European Investment Bank. (2011). *EIB Transport Lending Policy*. http://www.eib.org/attachments/strategies/transport_lending_policy_en.pdf. The EU Bank: Luxembourg. Access Date: 22 March 2016.

²² *EU Disability Strategy* - http://ec.europa.eu/smart-regulation/impact/planned_ja/docs/139_2_empl_disability_strategy_en.pdf; http://ec.europa.eu/development/body/publications/docs/Disability_en.pdf.

²³ European Commission. (2010). *Communication from the Commission to the European Parliament, the Council, the European Economic and Social Committee and the Committee of the Regions: European disability strategy 2010-2020: A renewed commitment to a barrier-free Europe*. (COM2010) 636 final. <http://eur-lex.europa.eu/legal-content/EN/TXT/PDF/?uri=CELEX:52010DC0636&from=EN>, Brussels, European Commission, p.4; Europe Aid. (2012). *Disability-inclusive development cooperation*. https://ec.europa.eu/europeaid/sites/devco/files/guide-disability-inclusive-development-cooperation-2012_en.pdf, Brussels, European Commission, p.4.

²⁴ European Commission. (2004). *Guidance note on disability and development for European Union delegations and services*. http://ec.europa.eu/development/body/publications/docs/Disability_en.pdf, Belgium, European Commission Directorate-General for Development.

²⁵ Europe Aid, (2012), op cit.



- working with DPOs and also providing capacity building support in the development of their management and organisational capabilities
- including accessibility as a criteria in programs and projects, with explicit reference in tenders and proposals
- recognising the additional discrimination among women and girls with disabilities, and
- having contact people in the European Union delegation offices for disability issues.

Japan International Cooperation Agency

Japan International Cooperation Agency (JICA) has thematic guidelines on disability and development²⁶. These were originally published in 2003 and modified in 2009. Information has been added about good practices, lessons learned, effective approaches and recommendations. The guidelines take into account the need for all people with disabilities to fully participate in their community and society, to enjoy their human rights, and to live within an equitable and inclusive society. The guidelines adopt the twin-track approach involving disability mainstreaming and disability-specific interventions, as well as other approaches including a person-centred approach, use of community-based rehabilitation and awareness-raising exercises.

The guidelines include a section devoted to Transportation and Disability (Section 3-4-4.) which explains challenges and consideration points from a disability and development perspective. Appendix 2 makes reference to JICA programs related to disability and development that have been implemented since 2000, including transport-related programs (Appendix 2-14 and 2-15). Appendix 5 recommends some indicators as baseline data and information for disability and development projects/programs.

New Zealand Government

The New Zealand Government has a strategy on disability which was introduced in 2001 and is being revised in 2016. This provides a framework to enable the government to identify and remove barriers that prevent people with disabilities from fully participating in society. It has been applied in the New Zealand Ministry of Foreign Affairs and Trade (NZMFAT), along with other government agencies working domestically or internationally. The current revision process is designed to take account of international and domestic developments since the initial strategy was released. It is expected to be fully aligned with the UNCRPD.

A key contribution that New Zealand has made internationally is the design standard known as NS4121:2001, *Design for Access and Mobility – Buildings and Associated Facilities*²⁷. This is managed by the Ministry of Business, Innovation and Employment (MBIE). The Standard serves as guidance for practitioners in making buildings and facilities accessible and fully usable by people with disabilities. A key feature is that it is one of the few standards where requirements are considered from the viewpoint of users rather than building owners. The Standard provides information about the dimensions and space needed to ensure that structures and layout of both public and private accommodation, facilities and features are accessible to and usable by people with disabilities. It also considers a holistic concept of approachability, accessibility and usability for practitioners to ensure that accessible facilities are taken into consideration at the onset and incorporated into the design as a whole.

26 Japan International Cooperation Agency. (August 2015). JICA Thematic guidelines: Disability and development. [http://gwwweb.jica.go.jp/km/FSsubject0601.nsf/ff4eb182720efa0f49256bc20018fd25/6de82b04d77d23b0492579d400283a2d/\\$FILE/JICA_TG_Disability%20and%20Development_2015.pdf%20.pdf](http://gwwweb.jica.go.jp/km/FSsubject0601.nsf/ff4eb182720efa0f49256bc20018fd25/6de82b04d77d23b0492579d400283a2d/$FILE/JICA_TG_Disability%20and%20Development_2015.pdf%20.pdf), Tokyo, Japan. Access Date: 19 April 2016.

27 Standards New Zealand. (2001). *Design for Access and Mobility – Buildings and Associated Facilities*, NZS4121:2001. <https://law.resource.org/pub/nz/ibr/nzs.4121.2001.svg.html>. New Zealand: Standards Council. Access Date: 16 March 2016.



The World Bank Group

The World Bank Group (WBG) recognises that addressing the needs of people with disabilities in developing countries is part of its core mission of poverty reduction. The World Bank finances development projects that may link to disability issues – including in improving education services, health care and transport - and works in a wide variety of disability-related fields, such as data collection and technical analysis. It has also provided assistance to governments to include accessibility features in the design of transport projects, particularly in Latin America, East Asia and the Middle East.

Published in 2013, the guideline on *Improving Accessibility to Transport for People with Limited Mobility* provides practical information about how best to include consideration of accessibility for people with limited mobility (PLM) by looking at the costs, benefits and implementation issues²⁸. The guide also summarises potential funding sources and mechanisms for providing accessibility improvements for people with limited mobility. Finally, it depicts an Operational Road Map which provides guidance on the process for designing accessibility for transport projects undertaken by the World Bank. Many case studies are used to illustrate how all these processes can be implemented.

Summary of Features in Guidelines

Table 3 provides an overview of features in the guidelines of individual PRIF agencies. This shows that PRIF agencies have a number of guidelines and tools that can be used in addition to this document. The aim in all cases is to assist in ensuring that accessible features become the norm in infrastructure designs and a reality in all projects in the future.

²⁸ World Bank Group - *Improving Accessibility to Transport for People with Limited Mobility (PLM), A Practical Guide Note*, May 2013 – http://www-wds.worldbank.org/external/default/WDSContentServer/WDSP/IB/2014/01/30/000442464_20140130093151/Rendered/PDF/Accessibility0Report0Final.pdf.

Table 3. PRIF Agency Guidelines on Accessibility

References	Key Issues	General Principles	Cost and Benefits	Checklists or Screening Tools	Case Studies/ Examples	Technical Details	Maintenance Issues	Services and Resources
ADB - <i>Universal Access in ADB Transport Projects</i>			✓			✓		
Australian Aid (DFAT) - <i>Accessibility Design Guide: Universal Design Principles for Australia's Aid Program</i>	✓	✓		✓	✓	✓		✓
European Investment Bank	Either adopts European Union policy or the existing policies in organisations involved in its lending programs							
European Union – <i>Guidance Note on Disability and Development; Disability Inclusive Development Cooperation</i>	✓	✓						✓
JICA - <i>Thematic Guidelines on Disability</i>	✓	✓	✓	✓	✓			✓
New Zealand – <i>NS4121:2001, Design for Access and Mobility – Buildings and Associated Facilities</i>				✓		✓		
World Bank - <i>Improving Accessibility to Transport for People with Limited Mobility (PLM), A Practical Guide Note</i>	✓		✓		✓	✓	✓	✓



Chapter 5. Audit of PRIF Agency Projects in Five Countries

Introduction

As part of this study, visits were made to five Pacific countries – Kiribati, Samoa, Solomon Islands, Tonga and Tuvalu. The purpose of the visits was twofold: to obtain a general overview of the status of infrastructure from an accessibility perspective and to conduct audits of a selection of PRIF agencyfunded projects. This means that the country-level observations are limited to what was observed at and nearby each of the project sites and in general movement within the capital city. They are not comprehensive audits of each country or all development projects in the country.

General Observations about Accessibility in the Five Countries

General observations about the five countries are as follows:

- there is generally no legal framework in respect to accessibility, including no national building codes or accessibility codes or regulations (Samoa being an exception with some Accessibility Guidelines)
- there is an absence of persons with disabilities moving around in the streets, in community spaces, in mainstream schools and at workplaces
- there is a general lack of awareness and understanding of disability issues
- in some countries, there is little or no access to usable or properly maintained mobility aids such as wheelchairs and walking crutches, and
- if a person acquires a disability later on in life, s/he is likely to be confined to the home, will have to stop attending school and/or will no longer be employable.

Audit Findings

This section of the document provides an overview from a sectoral perspective, as well as more detailed information on each of the countries visited in this study. They are based on observation by the consultant whilst in-country.

Air Transportation

Air transportation is the most costly means of travel in the Pacific but, due to geography, it is the preferred mode of transport for business travellers, perishable goods and tourists (other than those who travel on cruise ships). Among the five countries audited in this study, Samoa and Tonga currently have the best airport facilities, though even these airports need upgrading or maintenance to ensure that infrastructure is both accessible and usable. This presents an opportunity to incorporate comprehensive accessibility provisions into new aviation investment projects – both to foster increased tourist numbers and to improve air travel for local communities.

Importantly, more consideration needs to be given to ensuring that people with disabilities are able to safely board and disembark aircraft. Most countries lack the provision of a Disabled Passenger Lift (DPL) or aisle chairs to fit smaller planes, resulting in a situation whereby people who are unable to climb the stairs have to be physically carried up by the ground crew. The Solomon Islands is the only country visited that deployed a DPL and, although it was available in Fiji, it was not used.

Table 4 provides a summary of accessibility features in each of the countries in respect to aviation infrastructure, as observed through the projects audited as part of this study.

Table 4. Accessibility Features in Audited Aviation Infrastructure

Description	Kiribati	Samoa	Solomon Islands	Tonga	Tuvalu
Sheltered Link way from Apron to Terminal	None available	Available – linkway to terminal building is sheltered and there is no step difference on reaching the terminal	None available	None available	None available
Provision of Aisle Chair	Available – but training is needed for staff	Available – but training is needed for staff	Available – but training is needed for staff	Available – but training is needed for staff	None available
Disabled Passenger Lift (DPL)	None available	None available	DPL used	None available	None available
Entrance to Terminal	Stepped	Stepless	Stepless	Stepless	Stepped
Accessible Counters	None available – counters are too high for people in wheelchairs	None available – counters are too high for people in wheelchairs	None available – counters are too high for people in wheelchairs	None available – counters are too high for people in wheelchairs	None available – counters are too high for people in wheelchairs
Accessible Washroom	None available	Available	Available, but one was locked and the other was being used as a storeroom	Available	None available
Designated Sheltered Pick-up and Drop-off Points	None available	Available	Available	Available	None available
Designated Accessible Car Parks	None available	None available	None available	None available	None available
Other Basic Facilities and Furnishing e.g. seating, Automatic Teller Machine (ATM), money changer	None available	Available but not accessible in all cases	Available but not accessible in all cases	Available but not always accessible in all cases	None available



Maritime Transportation

Maritime transportation is a key mode of transportation in the Pacific region given there are countless number of islands that are geographically scattered. It is therefore essential for people travelling to or between islands as well as for commercial cargo and tourism. Despite this, maritime transportation is the least developed in terms of accessibility. Passenger terminals and vessels tend to be inaccessible for both people with disabilities and older people and there are presently no guidelines in most countries about how to construct accessible terminal buildings. Boarding and alighting from vessels is also challenging, largely due to the changing tide so consideration is needed in regard to the design of the vessel and the landing areas as well as facilities in terminals and on board vessels. Except for Samoa, the audit found that accessibility in maritime infrastructure is poor and passengers with disabilities need to rely on family and staff to physically lift them onto the vessel, which can be hazardous.

Table 5 provides a summary of accessibility features in each of the countries in respect to maritime infrastructure, as observed through the projects audited as part of this study.

Table 5. Accessibility Features in Audited Maritime Infrastructure

Description	Kiribati	Samoa	Solomon Islands	Tonga	Tuvalu
Ferry Terminal	Not accessible to People with Disabilities (PWDs)	Local inter-island ferry terminal has many accessible features including counters and seats Wharf and port - connectivity can be improved by installing a sheltered linkway. Toilets are not compliant with accessibility standards but can be easily modified to improve access.	No terminal for local ferry and no audit undertaken in international terminal <i>*Unable to gain access into international terminal *</i>	Not accessible to PWDs	Not accessible to PWDs
Jetty	Fixed – Not accessible to PWDs	Fixed – but boarding is possible via a bridge	Fixed – Not accessible to PWDs	Fixed - Not accessible to PWDs	Fixed - Not accessible to PWDs
Boarding Bridge	None available	Boarding bridge is provided for ambulant passengers. Wheelchair users must board where vehicles are driven onboard.	Makeshift gang plank used	Available	None available – people in wheelchairs have to be winched in the same manner as cargo
Linkway between Road, Terminal and Jetty	Uneven and poorly maintained path to vessel ramp for boarding	Gravel and uneven ground	Uneven and poorly maintained path to vessel ramp for boarding	Gravel and uneven ground	Need to cross road before entering wharf – uneven ground
Accessible Counters	None available	Low counter available	None available	None available	None available

Description	Kiribati	Samoa	Solomon Islands	Tonga	Tuvalu
Accessible Washroom	None available	Not compliant with international accessibility standards	None available	None available	None available
Designated 'Drop-off' and 'Pick up' Points	None available	Gravel and uneven - difficult for people who have impaired mobility	None available	None available	None available
Designated Accessible Car Parks	None available	None available	None available	None available	None available

Road Transportation

Road transportation is the principal mode of transportation in all the countries. It provides the means to move people and/or goods from one place to another within islands. In considering accessibility, it is important to include both the built infrastructure and common vehicular traffic such as buses, taxis, private cars and vans.

In many Pacific countries there is a striking difference between rural and urban areas in terms of the extent and quality of the road infrastructure. One of the issues is the noticeable lack of maintenance in rural areas on both roads and footpaths. In both urban and rural areas, public buses are not accessible so that even people on wheelchairs who can stand and/or walk a little still need help to board and depart buses. In addition, as buses in many counties are able to stop anywhere along the route, passengers with vision impairment can face the problem of not knowing where they should alight. Therefore, without the provision of accessible or specialised transport, many people with disabilities are confined to their own homes – unable to attend school or to be employed.

Another problem is the lack of connectivity for pedestrians. Footpaths, if provided, do not constitute a comprehensive network and are often not built according to globally-recognised standards needed to achieve accessibility. In addition, where footpaths are provided, these may be blocked by obstructions such as lamp posts, trees and parked vehicles. Hence, moving around in the community is quite challenging for people with disabilities and many do not attempt to do so.



Table 6 provides a summary of accessibility features in each of the countries in respect to road infrastructure, as observed through the projects audited as part of this study.

Table 6. Accessibility Features in Audited Road Infrastructure

Description	Kiribati	Samoa	Solomon Islands	Tonga	Tuvalu
Pedestrian Road Crossings	Newly rehabilitated roads have flat-top road humps which can be converted into raised crossings in future. However, at present the connection at the footpath needs to be improved.	Crossings are not designed to international accessibility standards, especially in the urban area as these are concave in design and not easy to get onto. Crossings at newly road rehabilitated projects are generally quite accessible.	No crossing at road level. Signals at crossings not practical due to frequent power outages. Underground crossing in town is locked and not usable.	There are traffic light at crossings, but not all have ramp access.	Road network is relatively simple and traffic volume is low. Marked crossings are rare and designs are inconsistent.
Road Humps	Design of new road humps are of a relatively of a good design. These are flat-top designs and easily convertible to a raised crossing in future.	No road humps noticed.	Local government implements both road humps and regulating strips in villages. In addition, in some rural areas, local communities have dug trenches or built humps to slow down passing traffic.	No road humps noticed.	Poor design – road humps have steep sides and are not properly finished, with sharp crowns at the road fringe. Would pose problems for people with disabilities, other pedestrians and motorcyclists.
Bridges	Many of the causeway bridges are in urgent need of repair.	Good design on the upgraded Vaitele Road. Footpath across the bridge is seamless with the surrounding area.	Many bridges do not have accessible paths for pedestrians. Some bridges have low/no side walls and pedestrians could fall into the water below.	Not checked	Not checked

Description	Kiribati	Samoa	Solomon Islands	Tonga	Tuvalu
Footpaths	Work is in progress in many sections of the roads and footpath which temporarily impedes accessibility.	Newly rehabilitated footpaths are generally quite accessible. However, there are inconsistent designs and many footpaths are not designed to international accessibility standards for town areas. Newly rehabilitated footpaths are generally quite accessible.	Blocked by street furniture or not designed according to international accessibility standards. Cars can be seen parked on footpaths. Design should ensure that edge along road is vertical and not mountable.	Blocked by street furniture. Needs improvement and better maintenance regime.	No segregated footpath. Road edge covered with loose gravel used as makeshift footpath. Pedestrians share road with vehicles.
Kerb Ramps	Not available for raised footpath. Most footpaths are at grade (same level as the road).	Poor maintenance and not designed for accessibility. Kerb ramp is steep and concave in design.	Some of the newer footpaths have kerb ramps but with a steep gradient. May be slippery when wet.	Poor maintenance. Kerb ramps in some areas are quite steep and/or obstructed.	None, given there are no raised footpaths.
Accessible Public Parking Space	None available	Not compliant with international accessibility standards. Obstructed and abused by drivers.	None available	None available	Traffic volume is low and driver park in available open areas.
Public Transport	Public transport consists of mini-vans which are not accessible to PWDs.	Local wooden bus (banana bus) built over a lorry. Has a very high first step and is not suitable for the elderly and PWDs.	Public transport consists of mini-vans which are not accessible to PWDs.	Not accessible to PWDs.	Limited but not accessible to PWDs



Description	Kiribati	Samoa	Solomon Islands	Tonga	Tuvalu
Bus Stops	Existing bus stops are not properly designed and maintained. New bus stops under construction are better but the design could be improved by building them on a raised platform and ensuring connection to the footpath.	Bus stop designs are inconsistent and buses can be 'flagged down' or set down passengers at any place along the route (even though there are designated bus stops). In the rural areas, bus stops are at the same level as the road. People with vision impairment would find it difficult to locate bus stops.	Bus stops not adequately maintained	Can be improved by ensuring connectivity to footpaths	Passengers can 'flag down' buses at any location and there are only a limited number of bus stops. These are not accessible, particularly for those with vision impairment who may be unable to locate the bus stop or the place where they need to alight.
Connectivity	Difficult to move around. Road rehabilitation work in progress to provide footpaths at road level.	Need to improve design of kerb ramps and maintenance of footpath (in particular for the town centre)	Difficult to move around due to obstructions and conditions of footpath	Need to remove or relocate obstructions on footpaths	Simple road network that lacks 'last mile' connectivity to homes, schools, hospital, etc.



Further Details about the Countries

Kiribati

Kiribati is comprised of 33 atolls and reef islands as well as one coral island²⁹. The land area is roughly 800 square kilometres, scattered over 3.5 million square kilometres. The permanent population of Kiribati was 103,058 in 2010, at least half of whom live on Tarawa Atoll, with more than 33% populating an area of about 16 square kilometres on South Tarawa.

The Bonriki International Airport at South Tarawa is relatively small, with two small old and inaccessible buildings. Arrival and departure terminals are connected with an open but sheltered viewing gallery and holding area.

In South Tarawa, the main ferry point is located at Betio, a single stretch of road with one side facing the sea for ships to dock and the other side for seafood processing warehouses. The terminal caters mostly to cargo and inter-island ferries. The terminal lacks facilities such as a ticketing booth, toilet, and boarding or alighting areas. In addition, it would be difficult for people with disabilities to travel on these vessels and they would need a lot of assistance if they had to do so.

Road conditions in South Tarawa are mostly poor and most roads need maintenance, especially at the various causeways. Gravel and sand cover stretches of the causeways making it challenging for motorists and pedestrians. At the time of the PRIF accessibility audit, sections of breakwater wall had given way to the waves and pieces of broken wall lay on the roadside, causing obstruction. Some parts of the road had also fallen through exposing the sea below. These had to be barricaded and motorists were being warned of the danger. There were numerous potholes in the area, with drivers 'weaving' in and out of the oncoming lane to avoid them. There were no footpaths in the area, so pedestrians were using the road or top of the breakwater wall. However, work was underway to improve the drainage, road and pedestrian infrastructure to make it more usable to everyone including people with disabilities.

From the airport heading North to Buota, unsealed roads were also poorly maintained. Numerous potholes stretched across the entire width of the road, with large muddy puddles forming in the rain. This made it difficult for pedestrians as there were no footpaths and it would be impassable for those with mobility impairment or on wheelchairs. Plans to upgrade this stretch of road were on hold.

Along the stretch of main road and the newly completed road rehabilitation project at Bikenibeu Feeder Road and Temaiku Area, flat top road humps were provided at intervals. Although these could be converted to raised crossings in future, it may not be seamlessly connected to the footpaths unless the footpaths are also raised in the process. Towards the west from the airport to Betio, extensive roadwork was underway as part of rehabilitation projects.

Samoa

Samoa has a total land area of 2,842 square kilometres consisting of the two main islands of Savai'i and Upolu (which account for 99% of the total land area) and eight small islets³⁰. The terrain is relatively flat.

There is good connectivity at Samoa Faleolo International Airport, with a sheltered walkway between the terminal building and tarmac area. It is also level throughout, making walking and moving in a wheelchair much easier. Accessible toilets and other facilities are available, though not all comply with accessibility standards.

²⁹ <https://en.wikipedia.org/wiki/Kiribati>

³⁰ <https://en.wikipedia.org/wiki/Samoa>



Likewise the local ferry passenger terminal consists of a reasonably accessible building with ticketing booths, holding areas while waiting for boarding and a boarding bridge to get into the vessel. For wheelchair users, access on board is via the vehicle ramp which is not ideal from a safety perspective and it has uneven corrugated surfaces. The vessel has provision for a small lift for vertical access to the passenger areas but it is small, it was not built to standard requirements for accommodating a wheelchair, and it was out-of-order at the time of visit by the PRIF consultant.

In the urban centre of Apia, the roads generally have raised footpaths. There is a stretch of recently completed road and pedestrian infrastructure along Vaitele Street that is well planned and has seamless connectivity to zebra crossings with signalised light indicators, protection railings and cemented bollards on the central island to protect pedestrians from being accidentally hit by vehicular traffic. Footpaths are generally raised footpaths or, in the absence of raised footpaths, they are demarcated to separate pedestrians from vehicular traffic flow. Street lighting is present and located on grass patches rather than on road pavement.

However, the design of the pedestrian footpaths is not ideal and does not conform to accessibility standards. Kerb heights are inconsistent and kerb ramps are not properly constructed and not usable by anyone with a disability. Moving around independently would be difficult for pedestrians on wheelchairs and those with mobility difficulties. Many wheelchair users would prefer to travel on the road than use the footpath.

Solomon Islands

The Solomon Islands covers a land area of 28,400 square kilometres, the distance between the westernmost and easternmost islands being roughly 1,500 kilometres³¹. The Santa Cruz group of islands (part of Temotu Province) is particularly isolated, being closer to Vanuatu than the capital city of the Solomon Islands (Honiara), while Bougainville is geographically part of the Solomon Islands but politically part of Papua New Guinea. This means that both aviation and maritime transportation are very important.

On arrival at Honiara International Airport, a DPL can be deployed, a safe and efficient way to de-plane onto the tarmac. The entrances to the terminal building are levelled and accessible with good vertical handle to accommodate a wide range of user heights. One of the major provincial airports is the Nusatupe Airstrip Terminal at Gizo. The airport terminal building is very small, up a high step and not accessible. Many passengers prefer to wait outside the building. The luggage trolleys are also parked outside the terminal. The only way to get to the main Gizo township is via boat. The jetty at Nusatupe was constructed to accommodate three heights/tide variations (low, mid and high tides), allowing the boat to pull up level to the jetty at all times.

Despite the importance of inter-island maritime transportation for both passengers and cargo, there is no local ferry terminal, only an uneven path from car parking to the boarding area, and a makeshift gangplank is used.

Road infrastructure also has problems. Even though the terrain in Honiara is undulating, roads are relatively level along most sections of the east and west Guadalcanal Highway. Towards the end of the West Guadalcanal Highway, which is not heavily populated, the terrain is somewhat hilly. There are many problems with the road and pedestrian infrastructure in Honiara, either in design, lack of maintenance (e.g. potholes), and/or illegal parking along road pavement. There is no proper bus terminal, but only a makeshift designated open area that acts as a bus terminal. In an effort to reduce congestion in the central area, bus commuters take a bus to the fringe of the city and change to a different bus to enter the city. This is inconvenient especially for people with disabilities as it means having to seek assistance twice.

³¹ https://en.wikipedia.org/wiki/Solomon_Islands



The footpaths in the city are often used by cars as parking spaces which block pedestrians and prevent wheelchair users from using it. Alternatively, footpaths 'double up' as alternative roads given the condition of the footpaths is sometimes better than the roads. A possible reason for the abuse of the footpath could be the design of the kerb sides which are ramped alongside the road, allowing cars to climb and park on the sidewalk. Kerb ramps are not widely used.

A taxi service is readily available in Honiara, but it is expensive for local community members particularly those who are not working (including people with disabilities and the elderly).

Tonga

The Kingdom of Tonga is an archipelago comprising 177 islands with a surface area of approximately 750 square kilometres spread over 700,000 square kilometres³². A total of 52 islands are inhabited by a population of 103,000, of which roughly 70% live on the main island of Tongatapu.

Moving within Fua'amotu International Airport does not pose much problem for people with disabilities. However, facilities such as toilets, teller machines, bench seats and the car park are not accessible. Use of a raised crossing from the terminal building to the car park is good, but the top surface is concave and could pose a safety hazard when wet. The surface of the car park is uneven and, therefore, not good for wheelchair users and the elderly.

On the mainland, the road infrastructure in the rural area does not have footpaths. However, in some areas, there are parts of the road reserve that serve as pedestrian footpaths. In the urban area, road kerbs exist but the heights are inconsistent. Ramps at kerbside are either not present or not well executed as most are concave in nature or obstructed with planter boxes or lamp posts located in the middle of the footpath - a permanent barrier to all users.

Tuvalu

Tuvalu is a small country with a population of approximately 11,000³³. The country is in Polynesia, roughly halfway between Australia and Hawaii. It consists of three reef islands and six atolls that are very low-lying. Total land area is only 26 square kilometres though the country's Exclusive Economic Zone includes an ocean area of 900,000 square kilometres.

Funafuti International Airport is a smallish airport which provides very basic facilities. Due to its size, moving around the airport is relatively straightforward. However, there are steps, narrow doorways, high makeshift counters and it lacks a proper path leading to the car park or the exterior of the terminal building, making the airport inaccessible to people with disabilities. Physical assistance would be required for those with mobility impairment to board and de-plane. With a plan in place to rebuild the airport, it is an opportune time to ensure that the new terminal will incorporate comprehensive and accessible provisions including a DPL and aisle chair to improve access into the aircraft.

The terrain in Tuvalu is fairly flat, with a simple road network. It should, therefore, be relatively easy for people with disabilities to move around, However, this is not the case. In the absence of functional mobility aids and means of accessible transport, many persons with disabilities stay indoors and are rarely seen in public.

³² <https://en.wikipedia.org/wiki/Tonga>

³³ https://en.wikipedia.org/wiki/Geography_of_Tuvalu



With only about eight kilometres of road infrastructure on the island, way finding is relatively simple. There is a single main road, Te Auala O Valaku, linking the northern and the westerly strips, cutting through the town centre where the airport and government buildings are situated. This and other roads lack footpaths to separate pedestrian from the vehicular traffic. In addition, there is poor path connectivity between road infrastructure and dwellings, the town council building, local shops, markets, hospital, schools and other developments as there is a lot of loose gravel and broken coral pieces, making it difficult for people with disabilities to leave their homes and move about.

Transportation is generally via cars and motorcycles. There are only two public buses on the island which run infrequently and other vehicular traffic is relatively low, though increasing over time. There are many potholes and raised road humps which have indirectly helped to regulate vehicular speed.

In addition, there are many small or exclusive jetties used by locals as a transfer point to the numerous outer islands. However, these are not accessible to people with disabilities given the lack of accessible footpath and an inaccessible boarding and alighting platform. Most ferry points are standalone structures and do not have basic facilities like toilets or sheltered waiting areas. Signage is also not available to provide information.

Chapter 6. Guidelines for Improved Accessibility

Introduction

This chapter provides guidelines which are designed to take global standards and general principles in individual PRIF agency policies and guidelines and make them appropriate to the Pacific context. They are not intended to be comprehensive or to result in Universal Design; rather, they represent key issues and 'next steps' in improving accessibility in the countries visited. PRIF agency personnel may also refer to their individual agency documentation for further information.

Some information is provided on general issues related to mobility for people with disabilities, followed by information about the different transport sub-sectors. The aviation and maritime sub-sectors are grouped together because there are many common features and the Table of Contents to find particular features of interest. Photographs and drawings are used extensively. They have been taken from various sources and are referenced for follow-up as needed.

Anthropometrics of People and Mobility Aids

It is important to be aware of the basic anthropometrics of people with disabilities, including different physical builds of people across the various Pacific countries. In addition, the types, size and space needed by mobility aids also differs between the countries. This includes modifications that may have made to standard mobility aids to suit the user's individual needs and the terrain s/he is traversing.

There are various dimensions for clear space needed by wheelchair users given in the different accessibility codes around the world. Figure 1 provides an overview of recognised 'comfortable space' needed by the different groups of people. These dimensions are important in helping to determine the widths of footpaths and corridors, though it can vary between countries depending on the different mobility aids being used there. Importantly, it is not only the space occupied by the wheelchair that must be considered, but also front and side reaches for the occupant and turning space.

Figure 1. Comfortable Widths Between Pedestrians

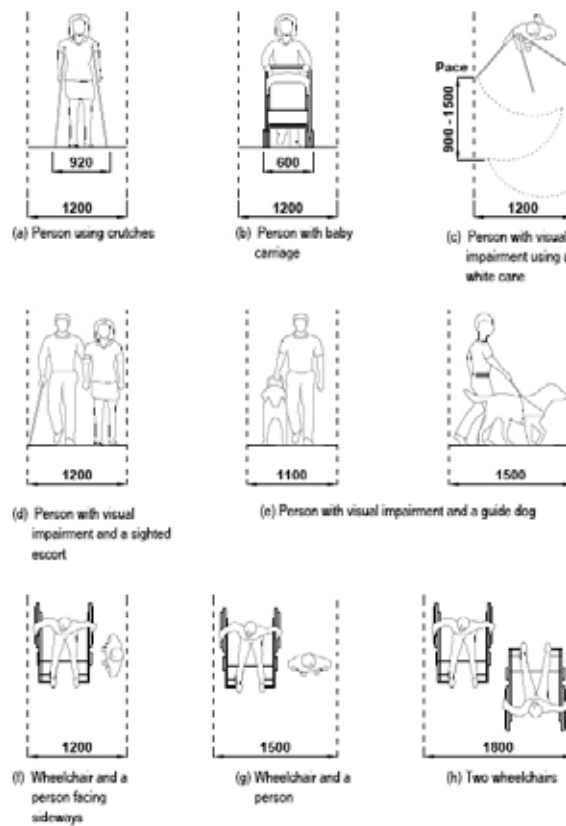

(Copied from Singapore Building and Construction Authority's Code on Accessibility in the Built Environment 2013)³⁴

Taking into consideration the size of people and the type of wheelchairs used in the Pacific, it is suggested that the Pacific adopts a minimum clear space of 900mm x 1300mm. This includes space for a person's elbows if they manually push their own wheelchair, as well as room for their feet which are likely to stick out from the footrest.

Figure 2 shows the dimensions (in mms) of a typical wheelchair with an adult user. It is suggested that this is verified in the country where infrastructure is being designed and built to ensure that correct and appropriate dimensions are being applied since the size of wheelchairs vary (as mentioned above).

34 Building and Construction Authority. (2013). Code on Accessibility in the Built Environment 2013. https://www.bca.gov.sg/BarrierFree/others/ACCESSIBILITY_CODE_2013.pdf. Singapore: Government of Singapore, p.162. Access Date: 26 March 2016.

Figure 2. Typical Wheelchair Dimensions

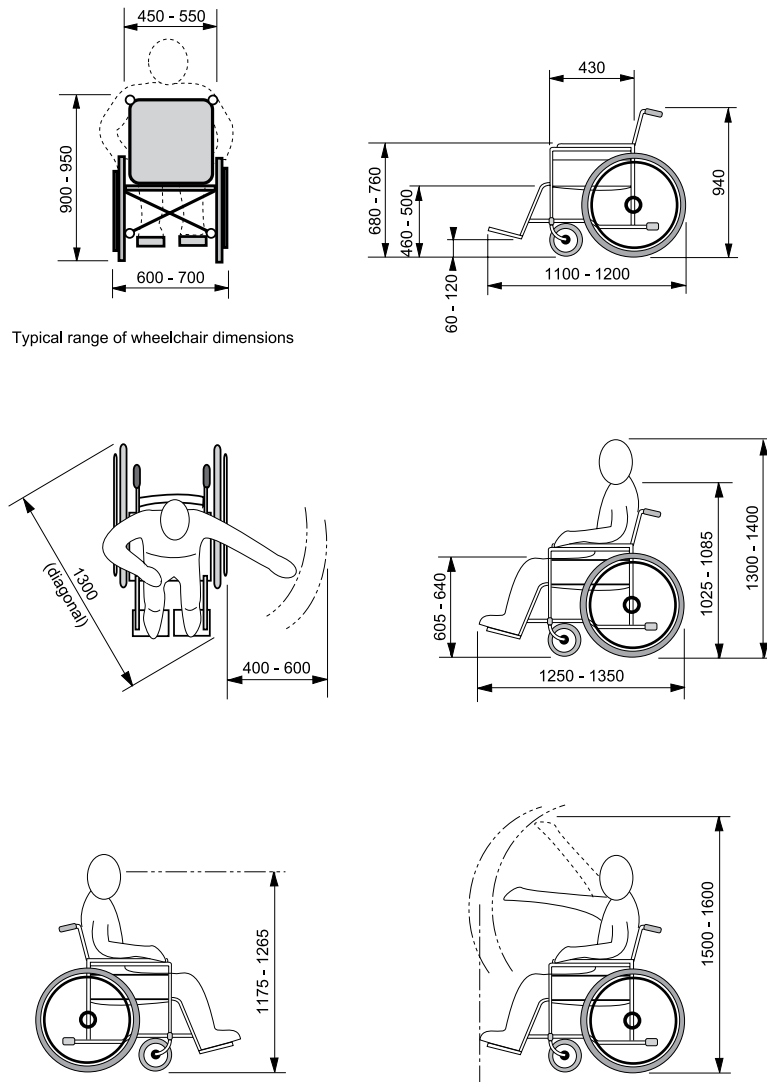

Typical range of wheelchair dimensions

(Reproduced with permission granted by Standards New Zealand under Licence 001195)³⁵

35 Standards New Zealand, (2001), op cit, p.111. Access Date: 16 March 2016.

A person who is seated on a wheelchair has limited height reaches. This may be coupled with an inability to raise their arms fully. Figure 3 shows the forward reach from a typical wheelchair.

Figure 3. Forward Reach from a Wheelchair

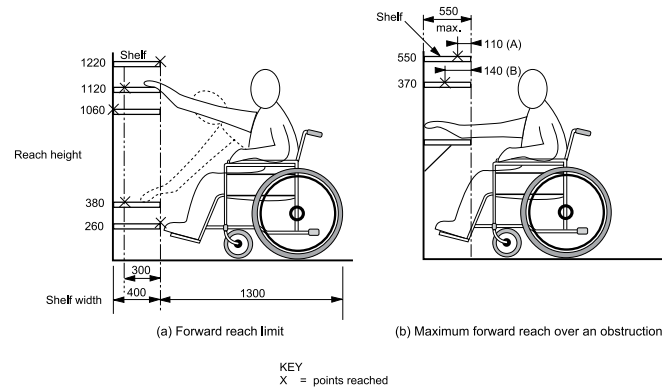

(Reproduced with permission granted by Standards New Zealand under Licence 001195)³⁶

Figure 4 shows the side reach from a typical wheelchair. It can be noticed that side reach is higher than the forward reach as it is not obstructed by the front castors on the wheelchair and it is possible to pull up closer to the object/installation.

Figure 4. Side Reach from a Wheelchair

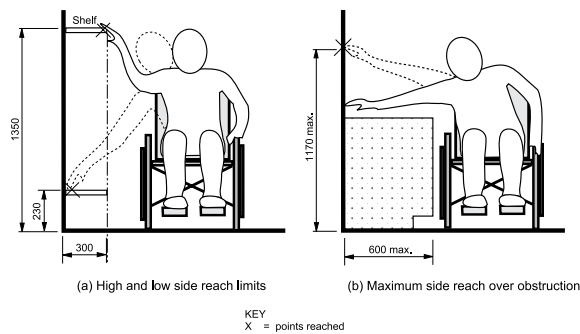

(Reproduced with permission granted by Standards New Zealand under Licence 001195)³⁷

³⁶ Standards New Zealand, (2001), op cit, p.115. Access Date: 16 March 2016.

³⁷ *ibid.*

Aviation and Maritime Infrastructure

This section of the report Guidelines describes key features of aviation and maritime infrastructure that need consideration in achieving accessibility for all. These two sub-sectors are included together because they have many common features. Where there are features only found in one of them (e.g. boarding and alighting flights) that will be clearly indicated. Otherwise, the comments refer to either of them, even if photographs are clearly of just one of them.

Terminal Buildings

At airports and ferry terminals, passengers with disabilities must be able to move freely into and within terminals, check-in, retrieve their luggage, catch a connecting flight/vessel as well as being able to take public transport to their intended destination. The following considerations apply to terminal buildings for use by the public:

- vehicle boarding and drop-off points
- bus stops and taxi stands (as described under 'Road Infrastructure')
- designated and accessible parking lot (as described under 'Road Infrastructure')
- trolley parking bays
- easy entrance to terminal buildings
- wayfinding, signage and audio announcements
- check-in facilities and interactive kiosks
- interior seating, resting and waiting areas
- washroom facilities
- Immigration and Customs areas
- boarding of aircraft and vessels, and
- baggage claim areas.

Boarding and 'Drop off'/'Pick Up' Points

It is important that boarding and alighting points designated for cars, taxis and other vehicles are firm and levelled. It is also necessary to ensure a safe, smooth, controlled and orderly flow of passengers in and out of the facility taking into consideration the location of such points to ensure they do not cause obstruction to human traffic (especially during peak hours). Where possible, such access paths should be sheltered and seamlessly connected.

The point of access into buildings should be via the main entrance, which should be stepless and levelled. If this is not possible, kerb ramps should be used to mitigate the height difference and bring visitors to the floor level of the building.

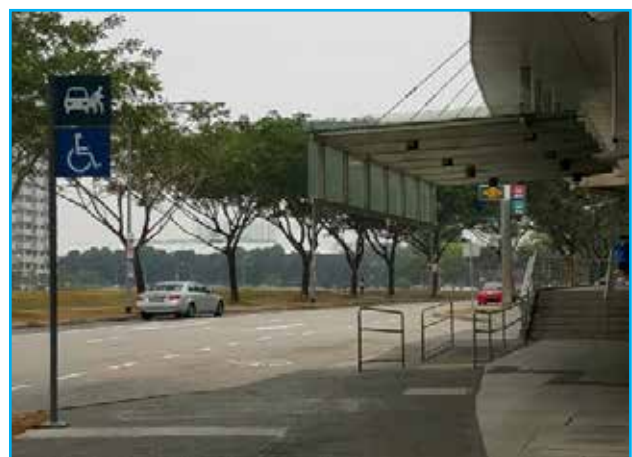

Ramped Entry at Drop-Off Point



Trolley Parking Bays

Locating trolley bays away from the main building should be avoided as it poses difficulties for people with disabilities. The situation is worsened if the path is unsheltered, especially during adverse weather conditions. Ideally, trolley bays should be located at the entrance to the departure hall and at the baggage claim area. Consideration should also be given to providing trolleys with auto-brakes so users have easier and better control of the trolleys.

Entrance to Terminal Buildings

Many buildings in PICs are built without an accessible entrance. With new construction taking place, it is important to ensure terminals and other buildings have accessible entrances – a first step towards inclusiveness. Entrances should comply with the following requirements:

- main or primary entrances to public buildings should be accessible
- entrances should be level and easy to locate
- each entrance should be connected by accessible footpaths and lead seamlessly into and out of the building, and to 'drop-off'/pick up' areas, parking and bus stops
- door width should be sufficiently wide, taking account of the volume of traffic to the building
- where possible, the door/s at the main entrance should be 'automatically opening'/sensor-controlled
- if glazed or glass doors are installed, these should have contrasting motifs across the glass at two heights to improve visibility for people with low vision and people of short stature, and
- if revolving doors are installed, a separate accessible doorway should be located nearby to provide access for users who are unable to access through revolving doors.



Designated Drop-off Point at Airport Terminal

Wayfinding, Signage and Audio Announcements

Moving in and around new or unfamiliar developments could pose a challenge to any first time visitor or tourists. An accessible and 'friendly' development will have signs which are easy to locate and understand as well as having good colour contrast with the surroundings. The use of pictograms instead of only text will also benefit those who are not familiar with the local language. For persons with vision impairment, provision of Braille and the use of audio announcements would be an added advantage. With a good wayfinding system in place, passengers are less likely to get lost and need to retrace their route, creating unnecessary human traffic and delays.



Large and Visible Signage Prominently Placed to Guide Visitors at Airport

Check-in Facilities and Interactive Kiosks

Many transactions take place over counters. Service staff at counters can either be standing or seated. In cases where sensitive transactions are carried out, such counters are usually built high or are located behind privacy shields which make it difficult for someone in a wheelchair or with a small stature to have the same engagement with the service staff. Hence, a mix of high and low counters is recommended. Effort must be taken to ensure that counters have the following specifications:

- maintain a direct line of sight to keep visual contact while communicating with the service staff
- where people may be required to complete forms, write on or sign documents, a writing platform of about 300mm deep is needed, and
- a clear knee space is needed to ensure that a wheelchair user can go close to the writing platform.



Low Counter Suitable for a Wheelchair User

Likewise, counters for foreign exchange transactions, phone booths and information counters should also be made accessible for travellers with disabilities. Where accessible counters are not available, it is helpful if staff walk out from behind the counter to serve passengers.

An interactive kiosk is any computer-like device deployed in public spaces to enable self-service access to product and services. Such kiosks are normally either 'standalone' or they are in banks of kiosks. At least one of each type of facility should be made accessible for people with disabilities and designated as such by affixing the International Symbol of Access (see below). Consideration for clear knee space access, appropriate height of screen display with all controls to be colour-contrasting and reachable by people on wheelchairs. The use of braille, audio and visual cues are an advantage to people with vision and hearing impairments. Lighting should not cause glare for users looking at the display screen or the screen could be made adjustable such that users could adjust the screen according to their height preference.



International Symbol of Access³⁸

38 https://www.google.com.au/search?q=international+symbol+of+access&rlz=1C1ARAB_enAU581AU581&espv=2&biw=1280&bih=869&tbn=isch&imgil=sr-FNSlvnDKD1M%253A%253B0V51z1prYuWdHM%253Bhttps%25253A%25252F%25252Fen.wikipedia.org%25252Fwiki%25252FInternational_Symbol_of_Access&source=iu&pf=m&fir=sr-FNSlvnDKD1M%253A%252C0V51z1prYuWdHM%252C_&usg=__Epl3f6jaw_QqBxNmZm2ub8UP6rk%3D&ved=0ahUKEwiTsaKlxuDLAhXn3KYKHsY7BnlQyjc1LA&ei=Tqf3YpPSKue5mwWm9piQBw#imgrc=sr-FNSlvnDKD1M%3A



There are three commonly-used positions for transferring to a water closet – side transfer, frontal transfer and diagonal transfer. All these transfer positions require the wheelchair user to turn his/her wheelchair and face the water closet at different angles. Therefore to accommodate the various transfer positions, individual washrooms must comply with the following specifications:

- have a minimum internal dimension of 1750mm x 1750mm as shown in Figure 5 (or sufficient internal dimension to accommodate local mobility devices e.g. modified wheelchairs)
- situate the water closet closer to one of the side walls so as to achieve sufficient turning space within the washroom for a wheelchair user
- have proper placement of grab bars to aid those who need a secure handhold and provide support when transferring to and from the water closet as well as when seated on the water closet
- ensure the door either swings outwards or is of the sliding type so that it does not interfere with the clear space within the washroom (this also aids rescue efforts during an emergency)
- include a horizontal pull grab bar on swing doors to enable users to pull the door close from the inside
- have a wash basin within with a lever handle faucet
- have a foldable grab bar mounted at the wide space adjacent to the water closet that can be stowed in the flip-up position so as not to obstruct the transfer space⁴⁰, and
- where possible, have an emergency alarm installed so users can call for help should it be needed.

Figure 6 illustrates the various ways a wheelchair user may transfer to the water closet. The most commonly used approach is the diagonal approach. The wheelchair is placed diagonally to the water closet and at an angle that depends on the user's strength and ability. The space around the water closet is essential to accommodate the various angles to enable the wheelchair user to transfer to and from the water closet.

⁴⁰ If flip-up grab bars are not available, do not provide any grab bar in its place.

Figure 6. Wheelchair Transfer - Side, Front and Diagonal Approaches

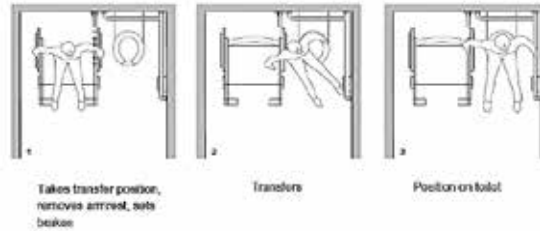

Wheelchair Transfer: Side Approach

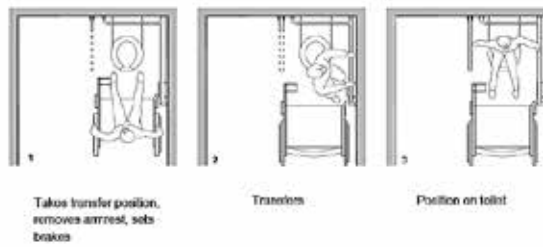

Wheelchair Transfer: Front Approach

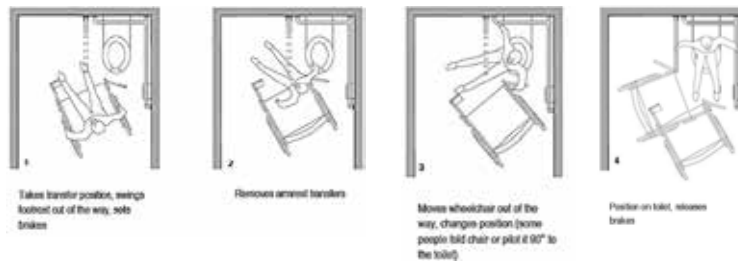

Wheelchair Transfer: Diagonal Approach

(Copied from Singapore Building and Construction Authority's Code on Accessibility in the Built Environment 2013)⁴¹

41 Building and Construction Authority, (2013), op cit, pp.124-125. Access Date: 26 March 2016.

Immigration and Customs Areas

For international arrivals and departures there are Immigration and Customs areas. Information provided earlier about counters in the departure hall can also be considered in the Immigration area. The area for security screening of people and baggage may involve metal detectors, full body X-ray machines or checking of bags by security personnel. As wheelchair users are unable to pass through the metal detector or X-ray screening, a separate path is needed that is sufficiently wide to allow them to easily negotiate without having to shift furniture or temporary barriers (such as Q-poles). Alternatively, a separate queue can be designated for people with disabilities, the elderly, and families with young children or with prams as they generally require more time than other passengers for checking, including unloading and repacking their belongings if required by security personnel. From the Immigration and Customs counters/areas to the boarding gate, the access path should be seamless.

Boarding and Alighting from Aircraft

Passengers needing assistance are usually accompanied by ground staff during the boarding and alighting processes. An aisle chair should be made available at all airports and within aircraft to facilitate boarding or disembarking people on wheelchairs or those with mobility limitations. The aisle chair is a specially designed wheelchair (preferably fitted with safety chest and lap belts) capable of fitting the narrow aisles of a plane. During flight, the aisle chair is used to facilitate access and transfer to the small toilet space within the aircraft.



Example of Aisle Chair Used in Aircraft⁴²

In most airports in developed countries, aerobridges are provided for passengers. These are enclosed, movable connectors that extend from the gate of a terminal building to the relevant aircraft, allowing passengers to seamlessly embark or disembark without having to go outside the building and potentially up and down flights of stairs.

However, in smaller, single level airports or at domestic terminals, aerobridges may not be available. In such instances, efforts must be undertaken by the airport authority to provide lifting devices, such as a Disabled Passenger Lift (DPL) or scissor lift for vertical transfer of person with disabilities from the tarmac into the aircraft. Ground crew need to be trained in the procedures for deploying the aisle chair and lifts to assist passengers accordingly.

⁴² Copied from <http://www.made-in-china.com/showroom/langjieco/product-detailpgWZKyMyohe/China-Airplane-Aisle-Chair.html>. Access Date: 22 March 2016.



Disabled Passenger Lift⁴³



Scissor Lift⁴⁴

Embarking and Disembarking from Vessels

In the maritime sub-sector, the embarking and disembarking of passengers with disabilities can pose more difficulties than with air travel as the size of vessels tends to vary from very small boats to large cruise ships and tide conditions can greatly affect the process. Finding one solution to fit all types of vessels is unlikely. One of the most significant issues is height difference between land/jetty and the vessel.

A fixed jetty with a floating platform is one solution.

A movable link bridge can also be used to connect between fixed and/or floating piers to help mitigate the impact of changing tides.



Fixed Jetty with Floating Platform



Movable Link Bridge

⁴³ <http://liftaloft.com/custom-aerial-lifts/airline-ground-support-equipment-gse/custom-solutions/spedpl-disabled-passenger-lifts/>. Access Date: 22 March 2016.

⁴⁴ <http://www.counterbalanceforklifttruck.com/sale-3205706-3-ton-industrial-hydraulic-scissors-lift-safety-5850mm-height-electric-scissor-lifts.html>. Access Date: 22 March 2016.

Boarding ramps can also be used to help overcome the gaps and height differences between the deck and moving vessels.

Where the height differences between high and low tides is significant, boarding bridges and ramps need to be longer so that they are not too steep, preferably not steeper than 1:12. Boarding bridges should also be sufficiently wide to accommodate wheelchairs and prams, be colour-contrasting with the deck to improve visibility and have handrails and raised edge protectors to prevent accidental falls. For larger cruise ships or vessels, a more complex boarding bridge may have to be deployed.

Vessels should also have sufficient deck spaces for wheelchair users to safely remain seated on their wheelchairs during short trips and seats for those who are unable to stand throughout the journey. If toilets are available onboard, at least one individual washroom should be provided together with an accessible path leading to the washroom. As the area can be expected to be wet, surfaces should be slip resistant. It is also important to have adequately trained crew as they play an important role to assist passengers with special needs safely in the embarking and disembarking process.

Baggage Claim Area

Baggage claim area should preferably be of the 'carousel' type as these have more inclusive layout and design compared to manual unloading which often leads to overcrowding in the luggage area. Counters should be available near the baggage claim area, so that passengers can seek assistance where necessary.

Road Infrastructure

Carriageway Layout

Figure 7 is a diagrammatic illustration of a typical layout for a dual carriageway road where specific spaces are allocated for services, vegetation and footpaths. It also includes drainage.



Portable Ramp



Wheelchair Space on Vessels

Figure 7. Typical Dual Carriageway Road

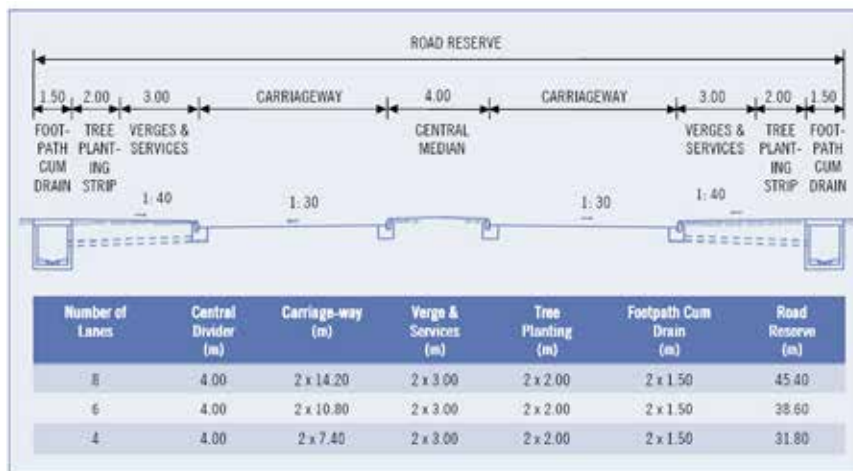

(Copied from Singapore's Land Transport Authority Code of Practice: Street Work Proposals Relating to Development Works)⁴⁵

Kerb Ramps

Kerb ramps or drop kerbs, as shown in Figure 8, have the important function of connecting raised footpaths to the surface of the adjoining road. They help pedestrians traverse between road junctions, crossings and when there are breaks in the footpath e.g. driveway entrance. When correctly constructed, kerb ramps allow wheelchair users to move on and off the footpath easily and without assistance. Warning tactile indicators at kerb ramps are essential to ensure the safety of persons with vision impairment.

Figure 8. Kerb Ramp with Flared Sides

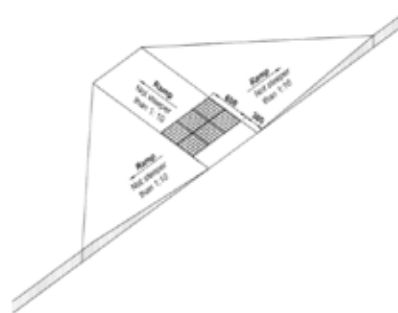

(Copied from Singapore Building and Construction Authority's Code on Accessibility in the Built Environment 2013)⁴⁶

45 Land Transport Authority. (2014). *Code of Practice: Street Work Proposals Relating to Development Works*. www.lta.gov.sg/content/dam/ltaweb/corp/Industry/files/COP-Appendices/RT-COP-V1.1.pdf, Singapore, p.77. Access Date: 24 March 2016.

46 Building and Construction Authority, (2013), op cit, p.29. Access Date: 26 March 2016.

Accessible kerb ramps should comply with the following:

- be at least 1000mm wide
- have a gradient not steeper than 1:12
- be free from obstructions such as lamp posts and traffic lights
- where there a flared sides for kerb ramps, these flared sides should not be steeper than 1:10 (see Figure 8), and
- have tactile indicators at the kerb edge.

Where footpaths lead to a driveway entrance, connect to adjoining roads or when footpaths are narrow and without sufficient landing space, it is necessary to consider implementing in-line ramps (see Figure 9). It is not advisable for kerb heights to be higher than 225mm as it will make the ramp incline very long.

Figure 9. Design of In-line Ramp

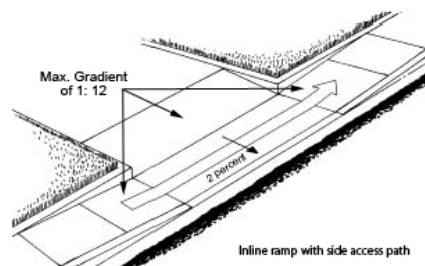

(Based on Federal Highway Administration, USA, *Designing Sidewalks and Trails for Access*, Chapter 5.5)⁴⁷

Where kerb ramps lead pedestrians into vehicular areas, warning tactile indicators must be provided to warn people with vision impairment that they are about to leave the safety of the footpath. These tactile indicators should be aligned perpendicular to the crossing zone, be set back 300mm from the edge and be 600mm wide to guide people with vision impairment. This is shown in Figure 10.

Figure 10. Tactile Indicators at Kerb Ramp

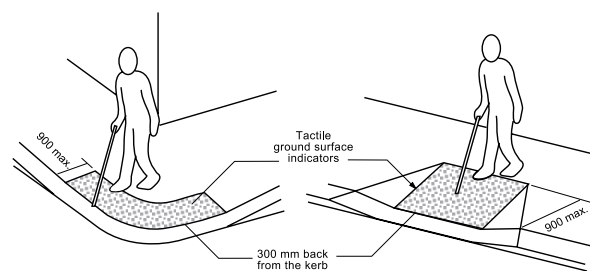

(Reproduced with permission granted by Standards New Zealand under Licence 001195)⁴⁸

⁴⁷ Federal Highway Administration, (2014). Bicycle and Pedestrian Program: Designing Sidewalks and Trails for Access. http://www.fhwa.dot.gov/environment/bicycle_pedestrian/publications/sidewalk2/sidewalks205.cfm#par, USA. Access Date: 22 March 2016.

⁴⁸ Standards New Zealand, (2001), op cit, p.74. Access Date: 16 March 2016.



The photo below is of the entrance to a driveway. The turning kerb is aligned with the gate post with tactile tiles located 300mm from the driveway.



Accessibility Features at Driveway Entrance

(Taken from Land Transport Authority, 2014, *Code of Practice: Street Work Proposals Relating to Development Works*)⁴⁹

Footpaths

Footpaths are used by pedestrians for a safe, clear and unobstructed passage from one point to another. These should:

- be firm, level and slip resistant to lessen effort by users and increase safety in negotiating the paths, especially when there is a need to go long distances
- be (preferably) raised at a height between 150mm and 225mm to improve the safety of pedestrians
- have a minimum unobstructed space (at least 1500mm) and be sufficiently wide to accommodate the expected volume of users and frequency of use within and around the development or facility, and
- have crossfalls or cambers across footpaths with gradients no steeper than 1:50 as illustrated in Figure 11⁵⁰.

If at-grade footpaths are used (i.e. footpaths at the same level as the road), these should have proper and clear demarcation especially in urban areas where there is more traffic.

Figure 11. Minimum Allowable Camber for Footpaths and Ramps

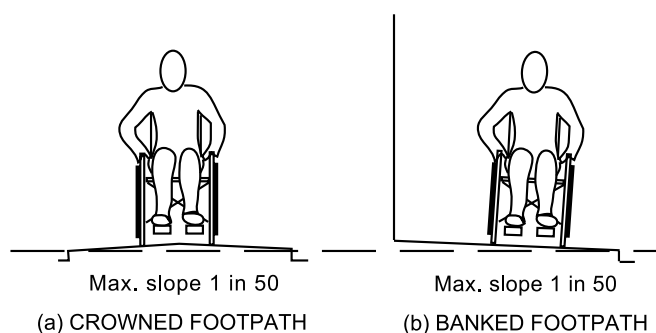

(Reproduced with permission granted by Standards New Zealand under Licence 001195)⁵¹

49 Land Transport Authority, (2014), op cit, www.lta.gov.sg/content/dam/ltaweb/corp/Industry/files/COP-Appendices/RT-COP-V1.1.pdf, p.35. Access Date: 24 March 2016.

50 Crossfalls or cambers aid water flow and discharge into nearby drains.

51 Standards New Zealand, (2001), op cit, p.32. Access Date: 16 March 2016.

All footpaths should be seamlessly connected to bus stops, taxi stands, building entrances and other amenities. The height of footpaths should be consistently applied within each country and, where possible, consider potential future introduction of low floor stepless buses. It should also be noted that the height of footpaths will also affect the length of the kerb ramps i.e. the higher the kerb, the longer the incline to accommodate the gradient not steeper than 1:12. In addition, the minimum space needed for two wheelchair users to comfortably pass each other needs to be provided for (i.e. at least 1800mm). Wider footpaths can be considered where they connect to places that expect a high level or surge of pedestrian traffic e.g. footpaths leading to a church, sports stadium and train station.

Crossings

Traffic junctions provide a more orderly use of the roads by vehicles and other road users including pedestrians while crossings ensure a degree of safety for all users. However, this is only true when everyone adheres to the set of rules as defined by each country.

Signalised pedestrian crossings and raised crossing have been successfully implemented in many countries. However, these are not commonly found in most Pacific countries. The use of technology at crossings such as 'the green human figure' with beeping sounds to guide vision impaired pedestrians can be considered at traffic junctions. Other types of crossings include underpasses and overhead bridges. If used, these should include the provision of slope ramps or lifts to overcome the height differences. Warning tactile indicators together with raised guiding material across the road (such as thermoplastic) is needed to guide people with vision impairment across the road.



Clearly Marked Pedestrian Crossing

(Copied from draft copy of Universal Access in ADB Transport Projects: Guidelines on Universal Access, Pedestrian Crossings)

Street Furniture

Street furniture forms an integral part of the overall road and street infrastructure. It provides facilities to help users in their daily activities or an acceptable level of comfort during their journey to their destination. Examples of street furniture include:

- sheltered walkways and trees to give protection from the elements
- waste bins, post boxes and seats for pedestrian convenience
- bollards, traffic lights and street lamps to ensure safety
- signs and advertising for direction and information, and
- fire hydrants and telephone posts providing essential services.



In planning the placement of street furnishing, it is important that these are located on or near grass verges/planters or at kerb side so that they do not cause obstruction to pedestrians, in particular wheelchair users and persons with vision impairment. The use of colour contrasting on street furniture or warning tactile indicators, railings or enclosures improves visibility and indicates the presence of such street furniture. This is also applicable in pedestrian malls to ensure a clear path of travel, as shown in Figure 12.



Seat with Armrests to Assist People with Disabilities or the Infirm

Figure 12. Example of Layout for Street Furniture

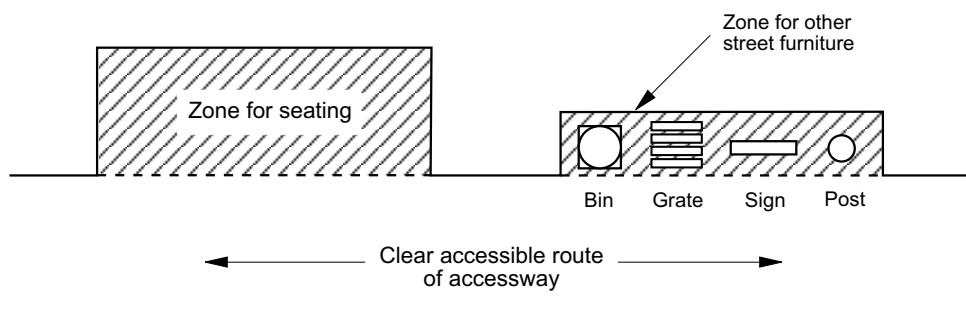

NOTE – There should be no projections into the accessible route.

(Reproduced with permission granted by Standards New Zealand under Licence 001195)⁵²

Reserved and Designated Parking Lots

Reserved parking lots for drivers with disabilities enable them to park their cars without having to compete with other drivers. The reserved parking lots should be located near to access points such as main entrance to the building or lift lobby and they should be sheltered where possible. The reserved parking lot must be able to accommodate wheelchair users, so it has to be a larger parking space to enable the person (or their carer) to fully open the vehicle door and have sufficient space for transfer between the vehicle and a wheelchair or vice versa. These parking lots must be clearly designated as being reserved for people with disabilities (usually by signage) or they will be used by other drivers. Accessible parking lots require the following specifications:

- located on firm and level ground
- parking space at least 4800mm x 3600mm
- a safe and more direct and accessible path (at least 1000mm wide) onto the footpath or development
- have a symbol of access painted on the floor/ground of the parking bay to identify it and improve visibility of the accessible parking space, and
- have a vertical sign to identify designated reserved parking lot – which is visible even when a vehicle is parked in the space

52 Standards New Zealand, (2001), op cit, p.76. Access Date: 16 March 2016.

Figure 13 indicates the typical size and location of reserved and designated parking lots.

Figure 13. Path Linking Accessible Carpark and Building

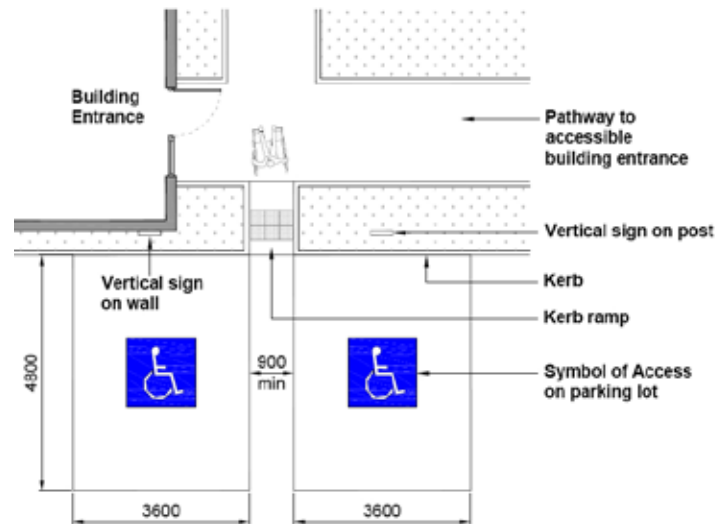

(Taken from Singapore Building and Construction Authority's Code on Accessibility in the Built Environment 2013)⁵³

Bus Stops and Taxi Stands

Designated bus stops and taxi stands provide users with a consistent point for alighting and boarding the public buses, vans and taxis. Such provisions help ensure safe and orderly boarding and alighting for all. However, bus stops are not available in all PICs. Even where there are bus stops, drivers may still board and alight passengers at any point along the route and there may not be clear scheduling so that passengers know when to expect the bus.

It is advisable that the following points be observed to improve the situation at bus stops for people with disabilities:

- seamlessly located on raised footpaths or platforms with ramps on both side to ease boarding
- be signposted so as to indicate location and presence of bus stop with service numbers
- bus schedule be made available at bus stops for the convenience of all users
- where possible, bus stops should be sheltered and have seats for those who unable to stand for long periods
- bus stops should be positioned in a manner that they maintain an unobstructed path to run along the rear of the bus stop for pedestrians passing the length of the bus stop.

These points are illustrated in Figures 14 and 15.

The use of raised bus stops will make any future transition to low floor stepless buses more seamless.

53 Building and Construction Authority, (2013), op cit, p.25. Access Date: 26 March 2016.

Figure 14. Layout for a Taxi Shelter

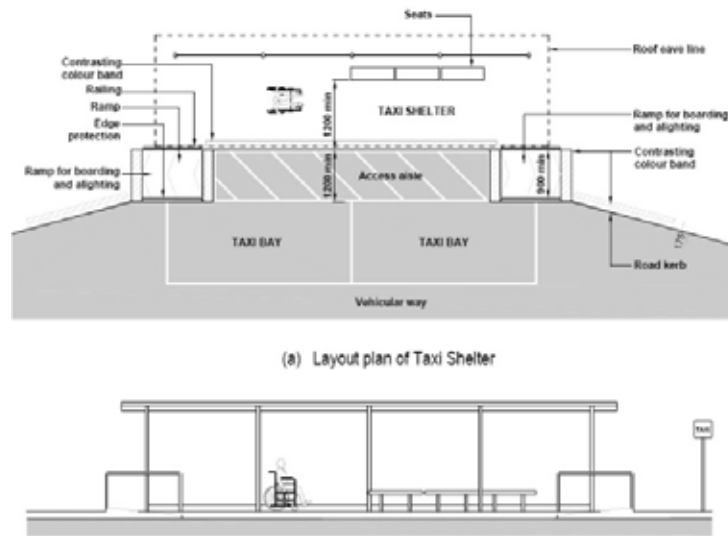

(Taken from Singapore Building and Construction Authority's Code on Accessibility in the Built Environment 2013)⁵⁴

Figure 15. Layout for a Bus Bay and Shelter

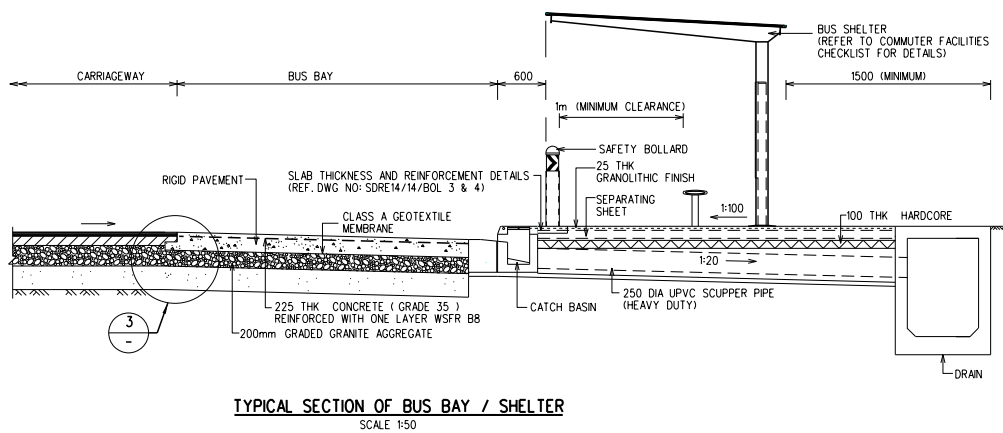

(Taken from [http://www.lta.gov.sg/content/dam/ltaweb/corp/Industry/files/SDRE\(2014\)/SDRE14-11BUS1-4.pdf](http://www.lta.gov.sg/content/dam/ltaweb/corp/Industry/files/SDRE(2014)/SDRE14-11BUS1-4.pdf); Access Date: 26 March 2016)

54 Building and Construction Authority, (2013), op cit, p.21. Access Date: 26 March 2016.



Seamless Connectivity

Having a good and accessible footpath or walkway is only part of a journey. It is also necessary to ensure there is seamless connectivity between home and final destination. This is essentially the ability to reach one's destination, amenities or communal spaces without having to overcome obstructions such as steps, uneven or broken pathways, narrow passageways, turnstiles or revolving doors, and escalators (in some countries).

To promote the use of public transport, it is important to improve 'last-mile connectivity' between transport hubs and the final destination as illustrated in the photos below. In many of the countries visited, gravel covered the majority of the 'last-mile connectivity' so that even though there was some accessible infrastructure, people with disabilities could not independently make the full journey they may need to. Hence, it is not only individual pieces of infrastructure that have to be considered, but the way they work in combination for easy movement about the local community and between different types of infrastructure and supporting services.



Accessible Crossings and Connected Paths



Chapter 7. Accessibility Screening Tool

Introduction

In addition to general information in the Guidelines in the previous chapter, Accessibility Screening Tools are included that staff in PRIF agencies (and others) will find useful in objectively rating the level of accessibility in proposed project designs, construction work prior to completion, or existing infrastructure that may then be subject to modification work. At each stage, when the screening tools are used correctly, the assessor will be able to determine the extent to which Barrier Free Accessibility and/or Universal Design achieved.

The Accessibility Screening Tools are in the form of checklists that are specifically designed for separate application with aviation, maritime, road and pedestrian infrastructure. They are 'user-friendly' for assessors who have some basic knowledge and understanding of accessibility requirements in the built environment and/or at least some technical engineering or architectural knowledge.

The checklists include features that allow an individual to successfully audit any infrastructure from onset/ arrival to gaining entry, relying on signs for way finding and connecting to various associated services. They allow the user to systematically check the provisions that are required and whether they have been correctly applied or compromised. Likewise, they can be used to assess designs prior to construction.

There are two scoring components – one for Barrier Free Accessibility and the other for Universal Design. For some projects, especially in the less-developed PICs, achieving even Barrier Free Accessibility will present challenges. Nonetheless, the screening tools can help increase awareness of areas where accessibility is needed to ensure compliance. For countries that are well placed to achieve Universal Design, the screening tools can be used to pin-point critical areas where there are shortcomings and indicate issues for further improvement, both for Barrier Free Accessibility and Universal Design.

For easy computation of the achieved targets, the screening tools employ spreadsheet software so that the scores can be easily computed and the project graded accordingly. If soft copy is not available, scoring will need to be undertaken manually. Blank copies of all three screening tool checklists are in Appendix D.

One of the checklists is shown overleaf, followed by an explanation of how to complete it. This one is for road and pedestrian infrastructure. Note that the forms refer to Barrier Free Access and Universal Design using acronyms 'BFA' and 'UD' to save space on the form.

Table 7. Template of Screening Tool Checklist: Road and Pedestrian Infrastructure

Assessor's Checklist - Road and Pedestrian Infrastructure											
Section	Category	Target Areas to Access	BFA Available Score	Project - Achieved BFA Score	UD Available Score	Project - Achieved UD Score	Remarks				
Pedestrian Infrastructure	Footpath	1 Footpaths or walkways are firm, level and slip resistant	3		1	0					
		2 Crossfalls or cambers across footpaths are not steeper than 1:50	1								
		3 No obstructions or undergrowth e.g. posts, grass or trees along footpath	2								
		4 Clear width of at least 1500mm along major footpaths and 1200mm for non-trunk footpaths (wider if high volume of pedestrian traffic is expected)	2								
		5 Where at-grade footpath is provided, vehicular and pedestrian spaces are clearly differentiated and demarcated	2								
		6 Height of raised footpaths is between 150mm and 225mm	1								
		7 Raised footpaths have kerb ramps with gradient not steeper than 1:12 at the both ends	2								
		UD Footpaths with clear width of at least 1800mm (to allow comfortable passing of wheelchairs, single and double prams, market trolleys, etc. to pass each other)					1				
	Sub-Score			13	0	1	0				
	Kerb Ramp & Road Kerb	1 Kerb ramps at least 1000mm wide and with gradient not steeper than 1:12	2		5	0					
		2 Incline of kerb ramps is consistent and has a flat surface (i.e. not concave or convex)	2								
		3 Kerb ramps with flared sides are not steeper than 1:10 (to prevent tripping where pedestrians are expected to walk)	1								
		4 Kerb ramps meet road seamlessly at road level - without any height difference i.e. without a drop or lip	1								
		5 Raised footpaths have kerb ramps or raised crossings to ensure seamless connectivity at crossings – Where footpaths are too narrow to accommodate level landing, provision of in-line ramps has been considered	2								
		UD Surface of kerb ramps are identified with a contrasting colour and different texture from the surrounding area					3				
		UD Raised footpaths with kerb ramps leading onto the road have tactile warning indicators					2				
		Sub-Score					8	0	5	0	
	Traffic Junction and Crossing	1 Accessible crossings (e.g. surface, raised, overhead or underground) provided to enhance pedestrian safety	3		6	0					
		2 Crossings seamlessly connect to footpath on both sides of road without having to traverse over grass or gravel, etc.	2								
		3 Overhead or underground crossings have slope ramps with handrails, gradient not steeper than 1:14 , or serviced by a lift on both sides of the crossing	3								
		4 Tactile warning indicators are installed at all crossings to notify pedestrians with vision impairment that they are leaving the safety zone of the footpath and going onto road	2								
		5 Call buttons and other crossing controls are placed at a height within reach of children and those in wheelchairs	2								
		6 Central traffic islands have street-level paths cut through for seamless access	2								
		7 Safety bollards or reinforced railings provided along footpath or at central island to protect pedestrians, where necessary	2								
		UD Crossings with audio (e.g. beeping sound) and visual feedback (e.g. green and red person symbols) to provide cue for pedestrians					2				
		UD Extended crossing duration option to accommodate persons with limited mobility					1				
		UD For residential areas where traffic speeds are lower, highly visible raised flat-top crossings are provided to improve safety for pedestrians					1				
		UD Crossings have contrasting detectable strips painted across the road and are demarcated with slightly raised thermoplastic to act as a guiding path for those with vision impairment					2				
		Sub-Score					16	0	6	0	
		Street Furniture	1 Street furniture placed away from footpaths to prevent obstructions to pedestrians	1				11	0		
	2 If street furniture is placed along footpaths, a clear unobstructed access path is maintained of at least 1000mm wide		1								
	3 Provision of sufficient street lighting , especially in urban areas		1								
4 Gratings and drain covers do not have gaps greater than 10mm , especially if located along footpaths – Gratings are placed perpendicular to the path of travel	2										
5 Overhanging objects (e.g. advertisement panels and street signs) are placed at a height that will allow pedestrians to safely pass underneath	2										
UD Permanent structures like lamp posts, post boxes and phone booths are colour contrasted with the surrounding area and have tactile warning indicators, railings or enclosures to warn pedestrians not to walk into them				4							
UD Signage and information boards are consistently located to aid users in way-finding				3							
UD Resting benches with armrest placed at regular intervals				2							
UD Low level and upward shining lighting (where provided) does not cause glare especially for the vision impaired				2							
Sub-Score			7	0	11	0					

Assessor's Checklist - Road and Pedestrian Infrastructure

Section	Category	Target Areas to Access	BFA Available Score	Project - Achieved BFA Score	UD Available Score	Project - Achieved UD Score	Remarks	
Pedestrian Infrastructure	Designated Reserved Parking Lots - accessible parking lot for drivers with disabilities	1	Designated reserved parking lot (situated along the roadside) does not encroach into footpath and cause obstruction to pedestrian flow	2				
		2	Designated reserved parking lot is on firm and level ground	2				
		3	Designated reserved parking lot is clearly demarcated with International Symbol of Access (on car park floor) to indicate location and purpose of such reserved parking lot	2				
		4	Additional vertical sign with International Symbol of Access to indicate presence of designated reserve parking lot – Sign is visible even when a vehicle is parked	2				
		5	Dimensions of accessible car park lot: 3600mm x 4800 mm for drivers with disabilities (wider space needed to assist in transfer)	1				
		6	Designated reserved parking lot with access path for a direct and seamless access from parking lot to pedestrian footpath	1				
		UD	Allocation of public or private car park zones instead of roadside parking to improve safety of drivers and passengers with allocation of an accessible parking lot with access path for a direct and seamless access from car park to pedestrian footpath			3		
		UD	There are warning signs and enforcement procedures (e.g. parking fines or wheel clamping) to deter and ensure that designated parking spaces are not misused or used by non-disabled drivers			2		
		UD	Family friendly lots provided for families with baby pram, elderly, etc.			1		
		Sub-Score			10	0	6	0
	Bus Stop / Taxi Stand	1	Bus bays and taxi lay-by are designed to accommodate the full length and width of the vehicle to make boarding and alighting easier and not hold up other vehicular traffic	3				
		2	Bus stop situated on raised platform of height between 150mm and 225mm to facilitate easy boarding – Standalone raised platforms have kerb ramps at both ends to connect to footpath	3				
		3	An accessible and unobstructed path to and from bus stop	2				
		4	Signage provided to indicate location and presence of bus stop with service numbers	2				
		5	Bus stop is sheltered and with seats provided	2				
		6	Presence of bus schedules at bus stop	1				
		7	If taxi stand is situated on a raised platform, at least one kerb ramp provided to connect from road level onto footpath	1				
		8	An accessible and unobstructed path to and from taxi stand	2				
		9	Signage provided to indicate location and presence of taxi stand	2				
		10	Taxi stand is sheltered and with seats provided	2				
	UD	Seating is available in various heights to cater to the need of different users			2			
	UD	Audio and visual cues used to aid users of varying needs			3			
	Sub-Score			20	0	5	0	
	Connectivity	1	Seamless connectivity between trunk or non-trunk footpaths to link directly to residential homes and buildings to ensure last mile connectivity	4				
		UD	Seamless connectivity from all bus stops and taxi stands to nearby public amenities to ensure that passengers are not left stranded after alighting			4		
	Sub-Score			4	0	4	0	
	Speed Regulators	1	Speed regulators used to calm or slow down vehicular traffic especially in residential areas	2				
	Sub-Score			2	0	0	0	
	Bonus Points	BFA	Overall design is integrated and promotes safety – Training and maintenance regime are in place to ensure facilities are well managed	5				
		UD	Overall design is safe and inclusive, welcoming and fully integrated – Training and maintenance regime and policies are in place to ensure amenities and facilities continue to be well managed – Developer has gone beyond BFAs requirements			5		
	Raw Total Score			85	0	43	0	

	Score	Percentage Achieved
Total Available BFA Score	100	0%
Barrier Free Accessibility Score Achieved	0	
Total Available UD Score	50	0%
Universal Design Score Achieved	0	

Name of Project:

Assessed by:

Date:

Note: Seamless Connectivity - refers to the ability to reach ones destination, amenities or communal spaces without having to overcome obstructions such as a step, uneven or broken pathways, narrow passageways, turnstiles or revolving doors, and escalators or travellators.



How to Complete the Screening Tool Checklists

The checklists are divided into several categories for each type of transport infrastructure. These categories specify target areas for compliance and implementation. In addition, there are two scoring components i.e. for Barrier Free Accessibility and Universal Design, each with pre-determined maximum allowable scores. Generally, each access requirement carries a score of “1”. Where a project or piece of infrastructure is assessed to comply with the required feature correctly, the Achieved Score will be computed and tallied accordingly.

Example 1

- Assessor’s Checklist: Road and Pedestrian Infrastructure
- Category: Footpath
- Target BFA⁵⁵ – Item 1: Footpaths or walkways are **firm, level** and **slip resistant**.
- BFA Available Score: 3

In computing the score for Example 1, each requirement i.e. firm, level and slip resistant carries one (1) point each. Therefore, if the footpath is only firm and level, two (2) points under **Project - Achieved BFA Score** is to be awarded.

Example 2

- Assessor’s Checklist: Road and Pedestrian Infrastructure
- Category: Connectivity
- Target UD⁵⁶: Seamless connectivity from **all bus stops, taxi stands** to **nearby public amenities** to ensure that one is not left stranded after alighting.
- UD Available Score: 4

In Example 2, the provision is considered as Universal Design i.e. beyond Barrier Free Accessibility. As there are numerous targets to achieve, scoring is to be awarded under **Project - Achieved Universal Design Score** as follows:

- one (1) point for connectivity to bus stops
- one (1) point for connectivity to taxi stands, and
- maximum of two (2) points for connectivity to nearby public amenities (even if there are more than two amenities located in close proximity).

Once all the Target Areas have been scored, the spreadsheet generates a percentage achieved under Barrier Free Accessibility and Universal Design (or it will need to be calculated manually). The Grading Score Chart determines the accessibility of a development or infrastructure. A score less than 75% for Barrier Free Accessibility targets does not meet the minimum specifications for barrier-free access and is unlikely to be usable independently by persons with disabilities.

55 Barrier Free Accessibility.

56 Universal Design.



Grading Score Chart

Gold	Achieved at least 85% for Barrier Free Accessibility targets
Silver	Achieved at least 75% for Barrier Free Accessibility targets
Gold Plus	Achieved at least 85% for both Barrier Free Accessibility and Universal Design targets
Silver Plus	Achieved at least 75% for both Barrier Free Accessibility and Universal Design targets

Example of a Completed Screening Tool Checklist

An example of a completed checklist is provided below from a project which was assessed as part of this research study. It has achieved a higher score for Barrier Free Accessibility than for Universal Design, but clearly there is more work to be done to have fully accessible infrastructure.

Table 8. Completed Example of Screening Tool Checklist

Assessor's Checklist - Air Infrastructure											
Section	Category	Target Areas to Access	BFA Available Score	Project - Achieved BFA Score	UD Available Score	Project - Achieved UD Score	Remarks				
Air Infrastructure	Designated Boarding & Alighting Points	1	Designated boarding and alighting point(s) (including bus bay, taxi stand) for visitors with disabilities	4	3		Does not have sign				
		2	Designated point(s) demarcated with clear and visible signs and International Symbol of Access	2	1						
		3	Designated zone is on firm and level ground	2	2						
		4	Designated zone is sheltered	1	1						
		5	Levelled/kerb ramp provides seamless access into terminal building	1	1						
		UD	Entire stretch of building entrance is levelled or gradually ramped from external footpath/drop-off into building with clear and differentiated demarcation between vehicular and pedestrian zones					3	0		
		UD	Where bollards are used, clear width between bollards is at least 900mm					1	0		
			Sub-Score					10	8	4	0
	Wayfinding	1	Information map in terminal building with good colour contrast against background	2	1						
		2	Use of directional signs to assist user in wayfinding at appropriate locations, use of colours, good visual height, etc.	4	2						
		3	Use of signage with good colour contrast against background	2	1						
		4	Audio and visual features in public address system	2	1						
		UD	Use of directional signs and pictograms to convey message to wide group of users						1	0	
		UD	Braille map at entrance with good contrast against background						2	0	
			Sub-Score						10	5	3
	Internal & External Furnishing	1	Lower counter at various service counters that cater for people with disabilities	4	0			Need to improve with low counter			
		2	Interactive kiosks that cater for people with disabilities	1	0						
		3	Seats with armrests to aid elderly or those with mobility limitations	1	1						
		4	Placement of furnishing does not obstruct passageway and allows a minimum clear access path of at least 1200mm wide	2	2						
		5	Priority lane or low counter for elderly and person with disabilities at locations such as check-in, Immigration and Customs	2	0						
		6	Designated baggage claim area (carousel design) easily reached by people with disabilities	2	2						
		7	Security screening area accessible to people with disabilities, with wide access path or separate access point	2	1						
		8	Trolley parking bay located within the same building and easily accessible – Trolley is auto-brake type	3	0						
		UD	Mix of low and high counters to cater for diverse group of users at various service counters						3	0	
		UD	Mix of seating that caters for diverse group of users (different heights and layout, with and without armrest)						2	1	
		UD	Designated and demarcated space at baggage claim carousel for passengers with disabilities						1	1	
		UD	Interactive kiosk with audio enhancement, braille and adjustable screen						3	0	
	Sub-Score			17	6	9	2				
Designated Reserved Parking Lots - accessible parking lot for drivers with disabilities	1	Car park has at least one reserved parking lot for drivers with disabilities (and ability to increase numbers when need arises)	1	0							
	2	Designated reserved parking lot is on firm and level ground	2	0							
	3	Designated reserved parking lot is clearly demarcated with International Symbol of Access (on car park floor) to indicate location and purpose of such reserved parking lot	2	0							
	4	Additional vertical sign with International Symbol of Access to indicate presence of designated reserve parking lot - Sign is visible even when a vehicle is parked	2	0							
	5	Dimensions of accessible car park lot: 3600mm x 4800 mm for drivers with disabilities (wider space needed to assist in transfer)	1	0							
	6	Directional signs to direct drivers with disabilities to designated reserved parking lot upon entering car park	2	0							
	7	Designated reserved parking lot with access path for a direct and seamless access from parking lot to pedestrian footpath	1	0							
	8	Seamless route from footpath into development	1	0							
	UD	Digital display system at car park entrance to inform drivers of location and availability of designated reserved lots						2	0		
	UD	Help call button installed nearby to such designated reserved lots						1	0		
	UD	Designated footpaths, crossings, blind spot mirrors and road humps to enhance safe movement for everyone within car park						3	0		
		Sub-Score						12	0	6	0
	Seamless Connectivity	1	Main or primary entrance to the building is accessible, level and easy to locate – It is also seamlessly connected to the exterior	3				3			
2		Within the terminal buildings, there is seamless and sheltered connectivity between the various functions such as arrival hall, departure hall, transit, baggage claim and duty free areas	4	4							
3		Accessible public transport like bus, rail and taxi to transfer elderly and people with disabilities from terminal to their destination and vice versa (<i>Note: 1 point for each mode</i>)	3	0							
4		For multi-storey terminals, vertical transfer is provided by lifts or elevators or slope ramp (not steeper than 1:14) to the various levels including viewing gallery	3	0							
5		All doorways are at least 850mm wide	2	2							
6		Door mats (if used) are flush with the floor surface and securely fastened at all edges	2	0							

Assessor's Checklist - Air Infrastructure

Section	Category	Target Areas to Access	BFA Available Score	Project - Achieved BFA Score	UD Available Score	Project - Achieved UD Score	Remarks		
Air Infrastructure	Seamless Connectivity	UD	Glazed or glass doors (if used) have visible and contrasting motifs placed at eye level (both children and adult heights) across the glass to improve visibility to people with low vision			2	0		
		UD	Where the terminals for domestic and international flights are located within the same development, these are seamlessly connected via sheltered walkways to facilitate easy transfer between terminals for everyone			3	0		
		UD	For larger airports with more than one terminal building, these are seamlessly connected via sheltered walkways to facilitate easy transfer between terminals or they are served by accessible shuttle or rail			3	0		
		UD	Use of braille/raised marking for texts and floor numbers and with audio announcements in lifts			2	0		
		UD	Use of automatic or sensor doors			1	0		
		Sub-Score				17	9	11	0
	Toilet/Washroom	1	At least one Individual Washroom is provided for people with disabilities at the departure area	1	0			Shared with Arrival Hall	
		2	At least one Individual Washroom is provided for people with disabilities at the arrival area	1	1				
		3	At least one Individual Washroom is provided for people with disabilities at the transit area	1	1				
		4	Signage like the International Symbol of Access and directional signs provided to direct and inform users on such provisions	2	0				
		5	Door of Individual Washrooms swing outwards or slide to facilitate rescue operation	1	1				
		6	Individual Washrooms complies fully with all required dimensions specified in the Accessibility Code (Note: 1 point each to be given for correct placement of water closet and wash basin, handrails, mirror, emergency call button and manoeuvring space)	4	2				Layout does not conform to International Standards
		UD	Individual washrooms are equipped with emergency call button with audio and visual feedback						3
	Sub-Score		10	5	3	0			
	Boarding, Deplaning and aircraft cabin	1	Primary entry and exit points at each building, terminal, arrival and transit area, etc. are accessible and seamlessly connected where such terminal buildings are not integrated within the same development (Note: 1 point for each building with at least one accessible entry and exit point)	4	3				
		2	Terminals are equipped with wheelchairs and other mobility aids for passengers who are unable to walk for long distances (Note: regular maintenance of wheelchairs is essential to ensure that these are in good working condition at all times)	3	1				
		3	Where the tarmac area is used for passengers to transfer between aircraft and terminal building, connection is via a clearly demarcated dedicated and seamless sheltered access walkway	2	2				
		4	Airport is equipped with aisle chair(s) for passengers with disabilities (Note: regular maintenance of aisle chairs are essential to ensure that these are in good working condition at all times)	2	1				
		5	Boarding and deplaning facilities like Disabled Passenger Lift (DPL) is provided in the absence of aerobridges (Note: regular maintenance of DPL is essential to ensure that these are in good working condition at all times)	2	0				
		6	Aerobridge(s) used to connect passengers between terminal and aircraft	2	0				
7		Sufficient turning space within the cabin for aisle chair to manoeuvre	1	0					
8		Accessible toilet within the aircraft to accommodate people using an aisle chair	1	0					
9		Armrest of aircraft seats are of the flip-up type to allow easy access for passengers with mobility impairment	2	2					
UD		Individual arriving and departing aircrafts are equipped with their own aisle chair (Note: While such requirement does not come under each project plan, having such requirements will highlight to service providers to consider such targets for future provisions)			2				0
UD		Staff (including frontline) are trained to assist, board and alight passengers with disabilities including deploying equipment such as boarding bridges			2				0
Sub-Score		19	9	4	0				
Bonus Point	BFA	Overall design is integrated and promotes safety. Training and maintenance regime are in place to ensure facilities are well managed.	5	2					
	UD	Overall design is safe and inclusive, welcoming and fully integrated. Training and maintenance regime and policies are in place to ensure amenities and facilities continue to be well managed. Developer has gone beyond BFAs requirements.			5	0			
Total Score			100	44	45	2			

	Score	Percentage Achieved
Total Available BFA Score	100	44%
Barrier Free Accessibility Score Achieved	44	
Total Available UD Score	50	4%
Universal Design Score Achieved	2	

Name of Project:
Samoa Aviation Investment Project

Assessed by:
Judy Wee,
Level Field Consultants

Date:
8th November 2014

Note: Seamless Connectivity - refers to the ability to reach ones destination, amenities or communal spaces without having to overcome obstructions such as a step, uneven or broken pathways, narrow passageways, turnstiles or revolving doors, and escalators or travellers.

Chapter 8. Conclusions and Recommendations

This study has shown that each transport sub-sector presents its own challenges in regard to ensuring accessibility and connectivity. Depending on the country and the mode of transport, different barriers exist and specific entry points can be pursued, in areas such as development of legislation and policy, financial allocation and management, technical and project-based implementation, training for staff and contractors. While there is some accessible infrastructure in the Pacific, it remains a challenging environment for people with disabilities. It results in exclusion of people with disabilities – from education, employment, tourism and general engagement in and contribution to their community.

The solution to the situation requires more than engineering alone. It is a combination of *Engineering, Education, and Enforcement* (the three Es)⁵⁷. *Engineering* deals with developing and regularly updating accessibility standards and guidelines to ensure they remain current and are incorporated into design work for infrastructure projects. This is a responsibility of both governments and their development partners. Importantly, by adopting appropriate standards in engineering designs and construction work, it avoids a situation where retro-fitting is required. Another critical consideration concerns how maintenance will be planned for, funded and undertaken, including any particular requirements associated with accessibility features. *Education* concerns the training required for Pacific authorities, DPOs and staff in development agencies to understand the *how* and *why* of standards and guidelines on accessibility. This document supports that process, but development agencies should also provide targeted capacity building for Pacific governments and others. That input should address technical issues as well as helping to increase community awareness about people with disabilities and their needs. *Enforcement* is the responsibility of governments. It requires appropriate legislation and regulations, clear assigned responsibility for enforcement of standards, and assessments and audits to ensure the standards are being met.

The following are broad recommendations to improve accessibility to transport infrastructure and the built environment. They apply to PRIF but also to country governments, DPOs and regional organisations.

⁵⁷ The concept of the three 'E's is extensively referenced in the literature e.g. in road safety and injury prevention (e.g. <http://www.buildings.com/buzz/buildings-buzz/entryid/139/education-engineering-and-enforcement.aspx>; <https://www.chilliwack.com/main/page.cfm?id=1361>; http://umaine.edu/ble/files/2011/01/EEE_08.pdf, http://www.transport-links.org/transport_links/filearea/documentstore/104_usmv2%20full.pdf - Access Date: 4th April 2016).



It is recommended that:

- all Pacific Island countries sign or ratify the United Nations Convention on the Rights of People with Disabilities as a first step towards recognising the need to promote inclusion of people with disabilities
- Pacific Island governments develop and implement basic Accessibility Codes and work towards Barrier Free Accessibility across transport networks and in the built environment, including seamless connectivity
- DPOs take a lead in fighting stigma by organising awareness campaigns to support better integration of people with disabilities into society, working with the authorities to promote understanding and application of the Accessibility Codes, coordinating with various authorities to plan and implement an accessible built environment and transport network, and organising activities for people with disabilities that enable them to be more engaged in the community
- PRIF agencies ensure that all new infrastructure and developments is designed and built to be accessible and in accordance with national legislation and policy, and
- PDF and PIFS establish a task force in each country that also includes relevant authorities and stakeholders to look into the planning, implementation, and maintenance of accessible infrastructure to accelerate the provision of a barrier free environment and associated capacity building requirements.



Appendix A

List of Participants at Focus Groups, Interviews and Meetings

In Kiribati:

- Mr Tekamangu Bwauira, Participant, Focus Group Discussion, Te Toa Matoa
- Mr George Fraser, Australian High Commissioner to Kiribati
- Mr Etekeru lotua, Deputy Captain Superintendent, Marine Training Centre
- Ms Nei Ren Itonga, Participant, Focus Group Discussion, Te Toa Matoa
- Ms Kantaake, Participant, Focus Group Discussion, Te Toa Matoa
- Mr Patrick Mannix, Kiribati Road Rehabilitation Project (KRRP) Technical Auditor and Advisor to Ministry of Public Works and Utilities (MPWU)
- Mr Tooma Mwakaa, Participant, Focus Group Discussion, Te Toa Matoa
- Mr Tataua Naboua, President, Te Toa Matoa
- Ms Teaimoti Nakekea, Participant, Focus Group Discussion, Te Toa Matoa
- Mr Panapa Pita, Quality Specialist, Ministry of Public Works and Utilities
- Mr Aree Redfern, Project Manager, Kiribati Aviation Investment Project
- Ms Regina Ritiata, Participant, Focus Group Discussion, Te Toa Matoa
- Ms Teetei Tabeibeti, Participant, Focus Group Discussion, Te Toa Matoa
- Ms Mekabwa Taberannang, Participant, Focus Group Discussion, Te Toa Matoa
- Mr Benitera Tabokai, Director Civil Aviation, Ministry of Communications, Transport and Tourism Development
- Mr Touai Tainimaki, Participant, Focus Group Discussion, Te Toa Matoa
- Mr David Teaato, Smaller Island States Officer, Ministry of Foreign Affairs and Immigration, Government of Kiribati
- Ms Aako Teikake, Deputy Director, Civil Aviation, Ministry of Communications, Transport and Tourism Development
- Ms Teteuna Tione, Participant, Focus Group Discussion, Te Toa Matoa
- Mr Baitongo Tirikai, Participant, Focus Group Discussion, Te Toa Matoa
- Mr Taake Tirobwa, Participant, Focus Group Discussion, Te Toa Matoa
- Mr Enoka Valo, Participant, Focus Group Discussion, Te Toa Matoa
- Mr Teeta Wiauea, Participant, Focus Group Discussion, Te Toa Matoa

In Samoa:

- Ms Faafofoga Auraa, Policy and Planning Officer, Ministry of Women, Community and Social Development, Research and Policy
- Ms Marie Bentin-Toalepaialii, Participant, Focus Group Discussion, Senese Inclusive Education
- Mr Tapaga Collins, Principal Surveyor, Maritime Division, Ministry of Works, Transport and Infrastructure
- Ms Jane Elliot, Participant, Focus Group Discussion, Aoga Fiamalamalama
- Ms Antonina Fosi, Intern, Internal for People with Disabilities, Ministry of Women, Community and Social Development, Research and Policy
- Mr Julai Gale, Participant, Focus Group Discussion, Nuanua O Le Alofa (NOLA)
- Mr Leasi Vainalepa Galuvao, Chief Executive Officer (CEO), Land Transport Authority
- Mr Tagaloa Ringo Jensen, Acting General Manager, Airport Services
- Ms Oa Talatau Konefesi, Participant, Focus Group Discussion, NOLA
- Mr Faafetai Koria, Assistant CEO, Ministry of Women, Community and Social Development, Research and Policy
- Mr Lavea Tupaimatuna Lulai Lavea, CEO, Ministry of Finance
- Mr Nofovaleane Mapusua, Focus Group Discussion, NOLA
- Mr Karl Nickel, Principal Licensing Officer, Civil Aviation Division

- Mr Noreo, Participant, Focus Group Discussion, NOLA
- Captain Herman Overhoff, Deputy Port Master
- Mr Leota Kapeneta Perelini, Assistant CEO, Ministry of Works, Transport and Infrastructure, Land Transport Division
- Mr Viliamu Punivalu, Project Manager, Samoa Aviation Investment Project
- SunGo Representatives (Umbrella Non-Government Organisation)
- Mr Toetu Taru, Participant, Focus Group Discussion, NOLA
- Mr Isaako Tufuga, Participant, Focus Group Discussion, NOLA
- Mr Tufuga To'alo Fagalao Tufuga, General Manager, Samoa Ports Authority
- Ms Titi Tuturanu, Procurement Engineer, Land Transport Authority
- Ms Fa'atino Masunu Utumapu, Office Manager, NOLA
- Ms Faaolo Utumapu-Utailesolo, Participant, Focus Group Discussion, Senese Inclusive Education
- Mr Vaaelua M. Nofo Vaaelua, Secretary for Transport / CEO, Ministry of Works, Transport and Infrastructure

In Solomon Islands:

- Mr Eddie Babanisi, Participant, Focus Group Discussion, Ministry of Health and Medical Services
- Mr Simon Dolaiano, Participant, Focus Group Discussion, Ministry of Women, Youth, Children and Family Affairs
- Mr Ionnis-Pavlos Evangelidis, Head of Development Cooperation, Delegation of the European Union to Solomon Islands and Vanuatu
- Mr Jiopu Iputu, Principal, Red Cross Special School
- Mrs Regina Lebo, Community-Based Rehabilitation (CBR) Coordinator and Physiotherapist at Gizo Hospital
- Mr Davis Luabolana, Participant, Focus Group Discussion, People With Disabilities
- Mr Ted McDonnell, Infrastructure Advisor, Ministry of Education
- Mr Scott McNamara, First Secretary, Economic Infrastructure, Australian High Commission, Honiara
- Mr Jabis Ngibutai, Participant, Focus Group Discussion, People With Disabilities
- Mr Yoshihiko Nishimura, Project Formation Advisor, Japan International Development Cooperation
- Ms Savina Nongebatu, Office Manager, People with Disabilities
- Mr Mike Qaqara, Deputy Director Transport, Ministry of Infrastructure Development
- Ms Anna Reid, Second Secretary – Development, New Zealand High Commission, Solomon Islands
- Mr Harry Rini, Director, Civil Engineering, Ministry of Infrastructure Development
- Ms Naomi Tai, Secretariat of the Pacific Community
- Ms Elsie Taloafiri, Physiotherapist and Disability Focal Point
- Mr Josefa Tuamoto, Solomon Islands Visitors Bureau
- Mr Ellison Tura, Participant, Focus Group Discussion, People with Disabilities - Solomon Islands
- Ms Mardi Trompf, Procurement and Project Management, Ministry of Education
- Mr Moses S Virivolomo, Permanent Secretary, Ministry of Infrastructure Development

In Sydney:

- Mr Rishi Adhar, Project Engineer, Asian Development Bank
- Mr Mark Barrett, Senior Sector Specialist – Transport Infrastructure, (Aust.) Department of Foreign Affairs and Trade
- Mr Christopher de Serio, Transport Specialist, The World Bank
- Ms Fiona Mackenzie, Project Officer, PRIF
- Mr Sanjivi Rajasingham, Director, PRIF Coordination Office
- Mr Jim Reichert, Senior Infrastructure Specialist (Pacific Region), The World Bank
- Ms Megan Schlotjes, Pavement Engineering Specialist, Transport and Infrastructure, World Bank
- Mr David Weinstein, Development Manager – Transport, NZMFAT
- Mr Oliver Whalley, Project Engineer – Infrastructure (Pacific Region), The World Bank
- Mr Jack Whelan, Secretariat Coordination Officer, PCO



In Tonga:

- Ms Kaufoou Amato, Office Manager, Naunau Alemaite Tonga Association (NATA)
- Mr Onetoto Anisi, Acting Chief Executive Officer for Ministry of Internal Affairs
- Ms Siunipa Isitolo, Participant, Focus Group Discussion, Naunau O' E' Alamaite, Tonga Association
- Mr Ofeina Leka, Participant, Focus Group Discussion, Naunau O' E' Alamaite, Tonga Association
- Ms Lavinia Satini Petesaita, Manager, Alonga Disabled Centre
- Ms Helen Po'uliva'ati-Toli, Tonga Project Manager, Tonga Aviation Investment Program
- Ms Ana Pela Talak, Participant, Focus Group Discussion, Naunau O' E' Alamaite, Tonga Association
- Mr Panela Tamale, Airport Manager, Kaufana Domestic Airport, Eua
- Ms Ahino Tonga, Participant, Focus Group Discussion, Naunau O' E' Alamaite, Tonga Association
- Mr Sateki Tuuholoaki, Participant, Focus Group Discussion, Naunau O' E' Alamaite, Tonga Association
- Mr Siaosi Vaka, Participant, Focus Group Discussion, Naunau O' E' Alamaite, Tonga Association
- Ms Meleane Vakalahi, Participant, Focus Group Discussion, Naunau O' E' Alamaite, Tonga Association

In Tuvalu:

- Ms Tealuga Aleni, Participant, Focus Group Discussion, Fusi Alofa Association
- Ms Alice Ave, Participant, Focus Group Discussion, Fusi Alofa Association
- Mr Kitiseni Eli, Participant, Focus Group Discussion, Fusi Alofa Association
- Ms Puaite Fauvaka Etuati, Secretary to Prime Minister
- Ms Lanieta Faleasiu, Government Disability Focal Point, Ministry of Community Development and Social Affairs
- Mr Ioane Hawaii, Participant, Focus Group Discussion, Fusi Alofa Association
- Mr Vitoli Iosefa, Project Manager, Tuvalu Road Resurfacing Project and Tuvalu Aviation Investment Project
- Mr Monise Loafai, Minister of Communications and Transport
- Mr Lakopa Ltaleli, Governor General of Tuvalu
- Hon. Mr Namoliki S Neemia, Minister of Home Affairs & Rural Development
- Mr Ielemia Papamau, Participant, Focus Group Discussion, Fusi Alofa Association
- Ms Losa Peau, Participant, Focus Group Discussion, Fusi Alofa Association
- Ms Mine Pilikosi, Participant, Focus Group Discussion, Fusi Alofa Association
- Ms Matakina Simii, Office Manager, Fusi Alofa
- Mr Vete P Sokai, Deputy Prime Minister and Minister for Public Utilities and Infrastructure
- Mr Isaia Taape, Permanent Secretary of Health, Ministry of Health
- Ms Eseta Talimanatu, Participant, Focus Group Discussion, Fusi Alofa Association
- Ms Rosalina Taulealea, Participant, Focus Group Discussion, Fusi Alofa Association
- Ms Planet Teaki, Participant, Focus Group Discussion, Fusi Alofa Association
- Mr Ampelosa M Tehulu, Director of Works, Ministry of Works, Water and Energy, Public Works Department
- Ms Mele Torai, Participant, Focus Group Discussion, Fusi Alofa Association
- Mr Taupaka Uatea, Participant, Focus Group Discussion, Fusi Alofa Association
- Mr Lipo Ulumutu, Participant, Focus Group Discussion, Fusi Alofa Association

Appendix B

List of Disabled Persons' Organisations

Country	Office Manager	Organisation Name	Address	Email Address	Telephone No.
Cook Islands	Pat Farr	Cook Islands National Disability Council	P.O. Box 1040, Rarotonga, Cook Islands	cindc14@oyster.net.ck	
FSM	Nelbert Perez (Founder)	Pohnpei Consumer Organization	P.O. Box 145, Kolonia, Pohnpei Zip Code 96941	nperez59@gmail.com	(691) 320-8415 (691) 320-1619
Fiji	Lanieta Tuimabu	Fiji Disabled Peoples Federation	FNCDP Complex, 3 Brown Street, Suva, Fiji PO Box 15178 Suva Fiji Islands	fdpfoffice@fdpf.com.fj ltuimabu@gmail.com	(679) 3311203 (679) 3581117 (679) 9069669
Kiribati	Mr. Tekamangu Bwauira	Te Toa Matoa	Anderson Causeway, Nanikaai Tarawa, Kiribati	tetoamatoak@gmail.com	(686) 22679 (686) 97409
Nauru	Terence Debao (Vice President)	Nauru Disabled Persons Organisation (NDPO)	Denigomodou District, Nauru P.O. Box 89, Nauru	terencedebao@gmail.com executive.ndpa@gmail.com	(674) 4443133 ext 264
Niue	Pui Pavihi	Niue Tolomaki Auloa Association (NTAA)	P.O. Box 142, Alofi, Niue	ntaa@niue.nu pavihi@niue.nu	(683) 3839/4287
Palau	Villany Remengesau (President)	Omekesang Association	OMEKESANG Shmull's Commercial Bldg Unit #4 PO Box 1909 Koror, PALAU 96940	vil_92000@yahoo.com omekesang@gmail.com	(680) 488 8502/1733 (680) 488 8502/1909

Country	Office Manager	Organisation Name	Address	Email Address	Telephone No.
Republic of Marshall Islands	Florence Ned	Marshall Islands Disabled Persons Organisation	Ministry of Internal Affairs Bldg Uliga Road P.O Box 3789, Majuro, Marshall Islands	Favianned001@gmail.com Paulmaddison1559@yahoo.com	(692) 625 – 8240/8718 (692) 625 - 5353 (625) 8414 / 455 5963
Samoa	Ms Faatino Utumapu	Nuanua O Le Alofa (NOLA)	Nia Mall (Pat Ah Him), Saleufi. P O Box 6235 Apia Samoa.	manager.nola@nola.org.ws f_masunu@samoa.ws	(685) 21147/8421147
Solomon Islands	Ms. Savina Nongebatu	People With Disabilities, Solomon Islands (PWDSI)	Development Service Exchange (DSE), Room 3, Lombi Crescent, New China town, Honiara, Solomon Islands	savinafnongebatu@gmail.com	(677) 25608 (677) 69350
Tonga	Ms Kafou Amato	Naunau O' E' Alamaite, Tonga Association (NATA)	Tonga National Youth National Congress, Kausela Road. P.O. Box 2670, Nuku'alofa, Tonga	org_natatonga@yahoo.com	(676) 28765
Tuvalu	Ms Matakina Simii	Fusi Alofa Association of Tuvalu	P.O Box 142, Vaiaku Funafuti, Tuvalu	fusialofa@gmail.com	(688) 20905
Vanuatu	Nelly Caleb National Coordinator	Disability Promotion and Advocacy Association	DPA Santo, P.O Box 71, Luganville, Santo, Vanuatu	calebnellie14@gmail.com dpasanto@vanuatu.com.vu	(678) 23589 / 37997 (678) 5421040

List of services provided at the above DPOs are as follows:

- Basic Services
- Training
- Advocacy and Awareness
- Referrals and Counseling

Appendix C

PRIF Agency Projects included in Audit

Transport Sub-Sector	Country	Project	PRIF Agencies
Aviation	Kiribati	Kiribati Aviation Investment Project**	DFAT, NZMFAT, WBG
	Samoa	Samoa Aviation Investment Project**	DFAT, NZMFAT
	Solomon Islands	Munda Airport Runway	NZMFAT
	Tonga	Tonga Aviation Investment Project	DFAT, WBG
		Eua Airport Upgrade	NZMFAT
Maritime	Kiribati	Maritime Training Centre	NZMFAT
	Tuvalu	Cargo/Passenger Vessel (Manu Folaw)	JICA
Road	Kiribati	Kiribati Road Rehabilitation Project	ADB, DFAT, WBG
	Samoa	Asset Management Project – Phase II	DFAT, WBG
	Solomon Islands	Solomon Islands Road Improvement Project (SIRIP)	ADB, DFAT, EU, NZMFAT
	Tuvalu	Tuvalu Aviation Investment Project**	DFAT, WBG

** These projects are part of the Pacific Aviation Investment Program (PAIP)

Appendix D

Accessibility Screening Tool for Aviation, Maritime and Road Infrastructure

These tables are available as Excel files by contacting PRIF at enquiries@theprif.org.

Assessor's Checklist - Aviation Infrastructure								
Section	Category	Target Areas to Access	BFA Available Score	Project - Achieved BFA Score	UD Available Score	Project - Achieved UD Score	Remarks	
Air Infrastructure	Designated Boarding & Alighting Points	1 Designated boarding and alighting point(s) (including bus bay, taxi stand) for visitors with disabilities	4					
		2 Designated point(s) demarkated with clear and visible signs and International Symbol of Access	2					
		3 Designated zone is on firm and level ground	2					
		4 Designated zone is sheltered	1					
		5 Levelled/kerb ramp provides seamless access into terminal building	1					
		UD Entire stretch of building entrance is levelled or gradually ramped from external footpath/drop-off into building with clear and differentiated demarcation between vehicular and pedestrian zones				3		
		UD Where bollards are used, clear width between bollards is at least 900mm				1		
	Sub-Score			10	0	4	0	
	Wayfinding	1 Information map in terminal building with good colour contrast against background	2					
		2 Use of directional signs to assist user in wayfinding at appropriate locations, use of colours, good visual height, etc.	4					
		3 Use of signage with good colour contrast against background	2					
		4 Audio and visual features in public address system	2					
		UD Use of directional signs and pictograms to convey message to wide group of users				1		
		UD Braille map at entrance with good contrast against background				2		
	Sub-Score			10	0	3	0	
	Internal & External Furnishing	1 Lower counter at various service counters that cater for people with disabilities	4					
		2 Interactive kiosks that cater for people with disabilities	1					
		3 Seats with armrests to aid elderly or those with mobility limitations	1					
		4 Placement of furnishing does not obstruct passageway and allows a minimum clear access path of at least 1200mm wide	2					
		5 Priority lane or low counter for elderly and person with disabilities at locations such as check-in, Immigration and Customs	2					
		6 Designated baggage claim area (carousel design) easily reached by people with disabilities	2					
		7 Security screening area accessible to people with disabilities, with wide access path or separate access point	2					
		8 Trolley parking bay located within the same building and easily accessible – Trolley is auto-brake type	3					
		UD Mix of low and high counters to cater for diverse group of users at various service counters				3		
		UD Mix of seating that caters for diverse group of users (different heights and layout, with and without armrest)				2		
		UD Designated and demarcated space at baggage claim carousel for passengers with disabilities				1		
		UD Interactive kiosk with audio enhancement, braille and adjustable screen				3		
		Sub-Score			17	0	9	0
	Designated Reserved Parking Lots - accessible parking lot for drivers with disabilities	1 Car park has at least one reserved parking lot for drivers with disabilities (and ability to increase numbers when need arises)	1					
		2 Designated reserved parking lot is on firm and level ground	2					
		3 Designated reserved parking lot is clearly demarcated with International Symbol of Access (on car park floor) to indicate location and purpose of such reserved parking lot	2					
		4 Additional vertical sign with International Symbol of Access to indicate presence of designated reserve parking lot - Sign is visible even when a vehicle is parked	2					
		5 Dimensions of accessible car park lot: 3600mm x 4800 mm for drivers with disabilities (wider space needed to assist in transfer)	1					
		6 Directional signs to direct drivers with disabilities to designated reserved parking lot upon entering car park	2					
		7 Designated reserved parking lot with access path for a direct and seamless access from parking lot to pedestrian footpath	1					
		8 Seamless route from footpath into development	1					
		UD Digital display system at car park entrance to inform drivers of location and availability of designated reserved lots				2		
UD Help call button installed nearby to such designated reserved lots					1			
UD Designated footpaths, crossings, blind spot mirrors and road humps to enhance safe movement for everyone within car park					3			
Sub-Score			12	0	6	0		
Seamless Connectivity	1 Main or primary entrance to the building is accessible, level and easy to locate – It is also seamlessly connected to the exterior	3						
	2 Within the terminal buildings, there is seamless and sheltered connectivity between the various functions such as arrival hall, departure hall, transit, baggage claim and duty free areas	4						
	3 Accessible public transport like bus, rail and taxi to transfer elderly and people with disabilities from terminal to their destination and vice versa <i>(Note: 1 point for each mode)</i>	3						
	4 For multi-storey terminals, vertical transfer is provided by lifts or elevators or slope ramp (not steeper than 1:14) to the various levels including viewing gallery	3						

Assessor's Checklist - Aviation Infrastructure

Section	Category	Target Areas to Access	BFA Available Score	Project - Achieved BFA Score	UD Available Score	Project - Achieved UD Score	Remarks	
Air Infrastructure	Seamless Connectivity	5 All doorways are at least 850mm wide	2					
		6 Door mats (if used) are flush with the floor surface and securely fastened at all edges	2					
		UD Glazed or glass doors (if used) have visible and contrasting motifs placed at eye level (both children and adult heights) across the glass to improve visibility to people with low vision			2			
		UD Where the terminals for domestic and international flights are located within the same development, these are seamlessly connected via sheltered walkways to facilitate easy transfer between terminals for everyone			3			
		UD For larger airports with more than one terminal building, these are seamlessly connected via sheltered walkways to facilitate easy transfer between terminals or they are served by accessible shuttle or rail			3			
		UD Use of braille/raised marking for texts and floor numbers and with audio announcements in lifts			2			
		UD Use of automatic or sensor doors			1			
	Sub-Score			17	0	11	0	
	Toilet/ Washroom	1 At least one Individual Washroom is provided for people with disabilities at the departure area	1					
		2 At least one Individual Washroom is provided for people with disabilities at the arrival area	1					
		3 At least one Individual Washroom is provided for people with disabilities at the transit area	1					
		4 Signage like the International Symbol of Access and directional signs provided to direct and inform users on such provisions	2					
		5 Door of Individual Washrooms swing outwards or slide to facilitate rescue operation	1					
		6 Individual Washrooms complies fully with all required dimensions specified in the Accessibility Code (Note: 1 point each to be given for correct placement of water closet and wash basin, handrails, mirror, emergency call button and manoeuvring space)	4					
		UD Individual washrooms are equipped with emergency call button with audio and visual feedback			3			
		Sub-Score			10	0	3	0
	Boarding, Deplaning and aircraft cabin	1 Primary entry and exit points at each building, terminal, arrival and transit area , etc. are accessible and seamlessly connected where such terminal buildings are not integrated within the same development (Note: 1 point for each building with at least one accessible entry and exit point)	4					
		2 Terminals are equipped with wheelchairs and other mobility aids for passengers who are unable to walk for long distances (Note: regular maintenance of wheelchairs is essential to ensure that these are in good working condition at all times)	3					
		3 Where the tarmac area is used for passengers to transfer between aircraft and terminal building, connection is via a clearly demarcated dedicated and seamless sheltered access walkway	2					
		4 Airport is equipped with aisle chair(s) for passengers with disabilities (Note: regular maintenance of aisle chairs are essential to ensure that these are in good working condition at all times)	2					
		5 Boarding and deplaning facilities like Disabled Passenger Lift (DPL) is provided in the absence of aerobridges (Note: regular maintenance of DPL is essential to ensure that these are in good working condition at all times)	2					
		6 Aerobridge(s) used to connect passengers between terminal and aircraft	2					
		7 Sufficient turning space within the cabin for aisle chair to manoeuvre	1					
		8 Accessible toilet within the aircraft to accommodate people using an aisle chair	1					
		9 Armrest of aircraft seats are of the flip-up type to allow easy access for passengers with mobility impairment	2					
		UD Individual arriving and departing aircrafts are equipped with their own aisle chair (Note: While such requirement does not come under each project plan, having such requirements will highlight to service providers to consider such targets for future provisions)			2			
	UD Staff (including frontline) are trained to assist, board and alight passengers with disabilities including deploying equipment such as boarding bridges			2				
Sub-Score			19	0	4	0		
Bonus Point	BFA Overall design is integrated and promotes safety. Training and maintenance regime are in place to ensure facilities are well managed.	5						
	UD Overall design is safe and inclusive, welcoming and fully integrated. Training and maintenance regime and policies are in place to ensure amenities and facilities continue to be well managed. Developer has gone beyond BFA's requirements.			5				
Total Score			100	0	45	0		

	Score	Percentage Achieved	Name of Project:
Total Available BFA Score	100	0%	_____
Barrier Free Accessibility Score Achieved	0		Assessed by: _____
Total Available UD Score	50	0%	Date: _____
Universal Design Score Achieved	0		

Note: Seamless Connectivity - refers to the ability to reach ones destination, amenities or communal spaces without having to overcome obstructions such as a step, uneven or broken pathways, narrow passageways, turnstiles or revolving doors, and escalators or travellators.

Section	Category	Target Areas to Access	BFA Available Score	Project - Achieved BFA Score	UD Available Score	Project - Achieved UD Score	Remarks	
Maritime Infrastructure	Designated Boarding & Alighting Points	1 Designated boarding and alighting point(s) (including bus bay, taxi stand) for visitors with disabilities	4					
		2 Designated point(s) demarcated with clear and visible signs and International Symbol of Access	3					
		3 Designated zone is on firm and level ground	2					
		4 Designated zone is sheltered	1					
		5 Levelled/kerb ramp provides seamless access into terminal building	1					
		UD Entire stretch of building entrance is levelled or gradually ramped from external footpath/ drop-off into building with clear and differentiated demarcation between vehicular and pedestrian zones				3		
		UD Where bollards are used, clear width between bollards is at least 900mm				1		
	Sub-Score			11	0	4	0	
	Wayfinding	1 Information map in terminal building with good colour contrast against background	2					
		2 Use of directional signs to assist user in wayfinding at appropriate locations, use of colours, good visual height, etc.	4					
		3 Use of signage with good colour contrast against background	2					
		4 Audio and visual features in public address system	2					
		UD Use of directional signs and pictograms to convey message to wide group of users				1		
		UD Braille map at entrance with good contrast against background				2		
	Sub-Score			10	0	3	0	
	Internal & External Furnishing	1 Lower counter at various service counters that cater for people with disabilities	2					
		2 Interactive kiosks that cater for people with disabilities	1					
		3 Seats with armrests to aid elderly or those with mobility limitations	1					
		4 Placement of furnishing does not obstruct passageway and allows a minimum clear access path of at least 1200mm wide	2					
		5 Priority lane or low counter for elderly and person with disabilities at locations such as check-in, Immigration and Customs	1					
		6 Designated baggage claim area (carousel design) easily reached by people with disabilities	2					
		7 Security screening area accessible to people with disabilities, with wide access path or separate access point	2					
		8 Trolley parking bay located within the same building and easily accessible – Trolley is auto-brake type	3					
		UD Mix of low and high counters to cater for diverse group of users at various service counters				3		
		UD Mix of seating that caters for diverse group of users (different heights and layout, with and without armrest)				2		
		UD Designated and demarcated space at baggage claim carousel for passengers with disabilities				2		
	UD Interactive kiosk with audio enhancement, braille and adjustable screen				3			
	Sub-Score			14	0	10	0	
	Designated Reserved Parking Lots - accessible parking lot for drivers with disabilities	1 Car park has at least one reserved parking lot for drivers with disabilities (and ability to increase numbers when need arises)	1					
		2 Designated reserved parking lot is on firm and level ground	2					
		3 Designated reserved parking lot is clearly demarcated with International Symbol of Access (on car park floor) to indicate location and purpose of such reserved parking lot	2					
		4 Additional vertical sign with International Symbol of Access to indicate presence of designated reserve parking lot - Sign is visible even when a vehicle is parked	2					
5 Dimensions of accessible car park lot: 3600mm x 4800 mm for drivers with disabilities (wider space needed to assist in transfer)		1						
6 Directional signs to direct drivers with disabilities to designated reserved parking lot upon entering car park		2						
7 Designated reserved parking lot with access path for a direct and seamless access from parking lot to pedestrian footpath		1						
8 Seamless route from footpath into development		1						
UD Digital display system at car park entrance to inform drivers of location and availability of designated reserved lots					2			
UD Help call button installed nearby to such designated reserved lots					1			
UD Designated footpaths, crossings, blind spot mirrors and road humps to enhance safe movement for everyone within car park				4				
Sub-Score			12	0	7	0		
Seamless Connectivity	1 Main or primary entrance to the building is accessible, level and easy to locate – It is also seamlessly connected to the exterior	3						
	2 Within the terminal buildings, there is seamless and sheltered connectivity between the various functions such as arrival hall, departure hall, transit, baggage claim and duty free areas	4						
	3 Accessible public transport like bus, rail and taxi to transfer elderly and people with disabilities from terminal to their destination and vice versa (Note: 1 point for each mode)	3						
	4 For small or makeshift terminals without provisions of basic functions, essential facilities such as the ticketing booth and toilets have appropriate signage to direct users to such facilities and are available for all passengers	2						
	5 For multi-storey terminals, vertical transfer is provided by lifts or elevators or slope ramp (not steeper than 1:14) to the various levels including viewing gallery	3						
	6 For multi-deck vessel, vertical transfer is provided by lifts or elevators or slope ramp (not steeper than 1:14) to the various decks including viewing deck	3						
	7 All doorways are at least 850mm wide	2						
	8 Door mats (if used) are flush with the floor surface and securely fastened at all edges	2						
	UD Glazed or glass doors (if used) have visible and contrasting motifs placed at eye level (both children and adult heights) across the glass to improve visibility to people with low vision				2			
	UD Where the terminals for domestic and international connecting schedule are located within the same terminal development, these are seamlessly connected via sheltered walkways to facilitate easy transfer between terminals for everyone				3			

Assessor's Checklist - Maritime Infrastructure

Section	Category	Target Areas to Access	BFA Available Score	Project - Achieved BFA Score	UD Available Score	Project - Achieved UD Score	Remarks	
Maritime Infrastructure	Seamless Connectivity	UD For larger terminals with more than one terminal building, these are seamlessly connected via sheltered walkways for easy transfer between terminals or they are served by accessible shuttle or rail			3			
		UD Use of braille/raised marking for texts and floor numbers and with audio announcements in lifts			2			
		UD Use of automatic or sensor doors			1			
		Sub-Score		22	0	11	0	
	Toilet/ Washroom	1	At least one Individual Washroom is provided for people with disabilities at the departure area	1				
		2	At least one Individual Washroom is provided for people with disabilities at the arrival area	1				
		3	At least one Individual Washroom is provided for people with disabilities at the transit area	1				
		4	Signage like the International Symbol of Access and directional signs provided to direct and inform users on such provisions	2				
		5	Door of Individual Washrooms swing outwards or slide to facilitate rescue operation	1				
		6	Individual Washrooms complies fully with all required dimensions specified in the Accessibility Code (Note: 1 point each to be given for correct placement of water closet and wash basin, handrails, mirror, emergency call button and manoeuvring space)	4				
		UD	Individual washrooms are equipped with emergency call button with audio and visual feedback			3		
		Sub-Score		10	0	3	0	
	Boarding, Alighting and sea vessel	1	Primary entry and exit points at each building, terminal, arrival and transit area, etc. are accessible and seamlessly connected where such terminal buildings are not integrated within the same development (Note: 1 point for each building with at least one accessible entry and exit point)	4				
		2	Terminals are equipped with wheelchairs and other mobility aids for passengers who are unable to walk for long distances (Note: regular maintenance of wheelchairs is essential to ensure that these are in good working condition at all times)	3				
		3	Where the boarding and alighting areas are located away from terminal building, connection is via a clearly demarcated, dedicated sheltered access walkway	2				
		4	There is a seamless access between the terminal and boarding/alighting platform	1				
		5	Use of boarding and alighting bridge (not steeper than 1:12) for seamless access between platform and vessel usable by everyone including the elderly and people with disabilities	2				
		6	There is sufficient turning space within the cabin for wheelchairs to manoeuvre	1				
		7	There is an accessible toilet within the vessel to accommodate people using wheelchairs	1				
		8	Where wheelchair users are required to remain seated in their wheelchairs for the duration of the trip, a designated space with sufficient turning space is allocated to position their wheelchair – Proper handhold is provided for steadying effect	2				
		9	Armrest of seats in the sea vessel are of the flip-up type to allow easy access for those with mobility impairment	2				
		10	Designated seats for elderly and people with disabilities have direct and unobstructed access to entrance and exit points to facilitate rescue	2				
		11	Centralised storage area for safe keeping of wheelchairs and other assistive aids	1				
		12	For vessels with multi-decks, there is provision of lift access to facilitate vertical transfer	1				
		13	There are alternative boarding and alighting facilities like lifting hoist in the absence of boarding and alighting bridge (Note: regular maintenance of all lifting devices is essential to ensure that these are in good working condition at all times)	2				
		UD	Boarding bridges are of a contrasting colour to the pier/pontoon with an edge protector and handrails on both sides			2		
		UD	Pier is colour contrasted with adjacent walkways and made of non-slip material			2		
		UD	Arriving and departing sea vessels are equipped with wheelchair and mobility aids (Note: While such requirement does not come under each project plan, having such requirements will highlight to service providers to consider such targets for future provisions)			2		
UD		Staff (including frontline) are trained to assist, board and alight passengers with disabilities including deploying equipment such as boarding bridges			2			
	Sub-Score		24	0	8	0		
Bonus Point	BFA	Overall design is integrated and promotes safety. Training and maintenance regime are in place to ensure facilities are well managed.	5					
	UD	Overall design is safe and inclusive, welcoming and fully integrated. Training and maintenance regime and policies are in place to ensure amenities and facilities continue to be well managed. Developer has gone beyond BFA's requirements.			5			
Total Score			108	0	51	0		

	Score	Percentage Achieved	Name of Project:
Total Available BFA Score	100	0%	_____
Barrier Free Accessibility Score Achieved	0		_____
Total Available UD Score	50	0%	_____
Universal Design Score Achieved	0		_____

Assessed by: _____

Date: _____

Note: Seamless Connectivity - refers to the ability to reach ones destination, amenities or communal spaces without having to overcome obstructions such as a step, uneven or broken pathways, narrow passageways, turnstiles or revolving doors, and escalators or travellators.

Assessor's Checklist - Road and Pedestrian Infrastructure

Section	Category	Target Areas to Access	BFA Available Score	Project - Achieved BFA Score	UD Available Score	Project - Achieved UD Score	Remarks		
Pedestrian Infrastructure	Footpath	1 Footpaths or walkways are firm, level and slip resistant	3						
		2 Crossfalls or cambers across footpaths are not steeper than 1:50	1						
		3 No obstructions or undergrowth e.g. posts, grass or trees along footpath	2						
		4 Clear width of at least 1500mm along major footpaths and 1200mm for non-trunk footpaths (wider if high volume of pedestrian traffic is expected)	2						
		5 Where at-grade footpath is provided, vehicular and pedestrian spaces are clearly differentiated and demarcated	2						
		6 Height of raised footpaths is between 150mm and 225mm	1						
		7 Raised footpaths have kerb ramps with gradient not steeper than 1:12 at the both ends	2						
		UD Footpaths with clear width of at least 1800mm (to allow comfortable passing of wheelchairs, single and double prams, market trolleys, etc. to pass each other)				1			
	Sub-Score			13	0	1	0		
	Kerb Ramp & Road Kerb	1 Kerb ramps at least 1000mm wide and with gradient not steeper than 1:12	2						
		2 Incline of kerb ramps is consistent and has a flat surface (i.e. not concave or convex)	2						
		3 Kerb ramps with flared sides are not steeper than 1:10 (to prevent tripping where pedestrians are expected to walk)	1						
		4 Kerb ramps meet road seamlessly at road level - without any height difference i.e. without a drop or lip	1						
		5 Raised footpaths have kerb ramps or raised crossings to ensure seamless connectivity at crossings - Where footpaths are too narrow to accommodate level landing, provision of in-line ramps has been considered	2						
		UD Surface of kerb ramps are identified with a contrasting colour and different texture from the surrounding area				3			
		UD Raised footpaths with kerb ramps leading onto the road have tactile warning indicators				2			
		Sub-Score			8	0	5	0	
	Traffic Junction and Crossing	1 Accessible crossings (e.g. surface, raised, overhead or underground) provided to enhance pedestrian safety	3						
		2 Crossings seamlessly connect to footpath on both sides of road without having to traverse over grass or gravel, etc.	2						
		3 Overhead or underground crossings have slope ramps with handrails, gradient not steeper than 1:14 , or serviced by a lift on both sides of the crossing	3						
		4 Tactile warning indicators are installed at all crossings to notify pedestrians with vision impairment that they are leaving the safety zone of the footpath and going onto road	2						
		5 Call buttons and other crossing controls are placed at a height within reach of children and those in wheelchairs	2						
		6 Central traffic islands have street-level paths cut through for seamless access	2						
		7 Safety bollards or reinforced railings provided along footpath or at central island to protect pedestrians, where necessary	2						
		UD Crossings with audio (e.g. beeping sound) and visual feedback (e.g. green and red person symbols) to provide cue for pedestrians				2			
		UD Extended crossing duration option to accommodate persons with limited mobility				1			
		UD For residential areas where traffic speeds are lower, highly visible raised flat-top crossings are provided to improve safety for pedestrians				1			
		UD Crossings have contrasting detectable strips painted across the road and are demarcated with slightly raised thermoplastic to act as a guiding path for those with vision impairment				2			
		Sub-Score			16	0	6	0	
		Street Furniture	1 Street furniture placed away from footpaths to prevent obstructions to pedestrians	1					
	2 If street furniture is placed along footpaths, a clear unobstructed access path is maintained of at least 1000mm wide		1						
	3 Provision of sufficient street lighting , especially in urban areas		1						
4 Gratings and drain covers do not have gaps greater than 10mm , especially if located along footpaths - Gratings are placed perpendicular to the path of travel	2								
5 Overhanging objects (e.g. advertisement panels and street signs) are placed at a height that will allow pedestrians to safely pass underneath	2								
UD Permanent structures like lamp posts, post boxes and phone booths are colour contrasted with the surrounding area and have tactile warning indicators, railings or enclosures to warn pedestrians not to walk into them					4				
UD Signage and information boards are consistently located to aid users in way-finding					3				
UD Resting benches with armrest placed at regular intervals					2				
UD Low level and upward shining lighting (where provided) does not cause glare especially for the vision impaired					2				
Sub-Score			7	0	11	0			

Assessor's Checklist - Road and Pedestrian Infrastructure

Section	Category	Target Areas to Access	BFA Available Score	Project - Achieved BFA Score	UD Available Score	Project - Achieved UD Score	Remarks	
Pedestrian Infrastructure	Designated Reserved Parking Lots - accessible parking lot for drivers with disabilities	1 Designated reserved parking lot (situated along the roadside) does not encroach into footpath and cause obstruction to pedestrian flow	2					
		2 Designated reserved parking lot is on firm and level ground	2					
		3 Designated reserved parking lot is clearly demarcated with International Symbol of Access (on car park floor) to indicate location and purpose of such reserved parking lot	2					
		4 Additional vertical sign with International Symbol of Access to indicate presence of designated reserve parking lot – Sign is visible even when a vehicle is parked	2					
		5 Dimensions of accessible car park lot: 3600mm x 4800 mm for drivers with disabilities (wider space needed to assist in transfer)	1					
		6 Designated reserved parking lot with access path for a direct and seamless access from parking lot to pedestrian footpath	1					
		UD Allocation of public or private car park zones instead of roadside parking to improve safety of drivers and passengers with allocation of an accessible parking lot with access path for a direct and seamless access from car park to pedestrian footpath				3		
		UD There are warning signs and enforcement procedures (e.g. parking fines or wheel clamping) to deter and ensure that designated parking spaces are not misused or used by non-disabled drivers				2		
		UD Family friendly lots provided for families with baby pram, elderly, etc.				1		
	Sub-Score			10	0	6	0	
	Bus Stop / Taxi Stand	1 Bus bays and taxi lay-by are designed to accommodate the full length and width of the vehicle to make boarding and alighting easier and not hold up other vehicular traffic	3					
		2 Bus stop situated on raised platform of height between 150mm and 225mm to facilitate easy boarding – Standalone raised platforms have kerb ramps at both ends to connect to footpath	3					
		3 An accessible and unobstructed path to and from bus stop	2					
		4 Signage provided to indicate location and presence of bus stop with service numbers	2					
		5 Bus stop is sheltered and with seats provided	2					
		6 Presence of bus schedules at bus stop	1					
		7 If taxi stand is situated on a raised platform, at least one kerb ramp provided to connect from road level onto footpath	1					
		8 An accessible and unobstructed path to and from taxi stand	2					
		9 Signage provided to indicate location and presence of taxi stand	2					
		10 Taxi stand is sheltered and with seats provided	2					
UD Seating is available in various heights to cater to the need of different users				2				
UD Audio and visual cues used to aid users of varying needs				3				
Sub-Score			20	0	5	0		
Connectivity	1 Seamless connectivity between trunk or non-trunk footpaths to link directly to residential homes and buildings to ensure last mile connectivity	4						
	UD Seamless connectivity from all bus stops and taxi stands to nearby public amenities to ensure that passengers are not left stranded after alighting				4			
Sub-Score			4	0	4	0		
Speed Regulators	1 Speed regulators used to calm or slow down vehicular traffic especially in residential areas	2						
	Sub-Score			2	0	0	0	
Bonus Points	BFA Overall design is integrated and promotes safety – Training and maintenance regime are in place to ensure facilities are well managed	5						
	UD Overall design is safe and inclusive, welcoming and fully integrated – Training and maintenance regime and policies are in place to ensure amenities and facilities continue to be well managed – Developer has gone beyond BFA's requirements				5			
Raw Total Score			85	0	43	0		

	Score	Percentage Achieved
Total Available BFA Score	100	0%
Barrier Free Accessibility Score Achieved	0	
Total Available UD Score	50	0%
Universal Design Score Achieved	0	

Name of Project:

Assessed by:

Date:

Note: Seamless Connectivity - refers to the ability to reach ones destination, amenities or communal spaces without having to overcome obstructions such as a step, uneven or broken pathways, narrow passageways, turnstiles or revolving doors, and escalators or travellers.



Appendix E

Other Resource Materials

Access Exchange International. (2012). *Paratransit for mobility-impaired persons in developing regions: Starting up and scaling up*. <http://www.globalride-sf.org/paratransit/Guide.pdf>, San Francisco, USA: Access Exchange International. Access Date: 20 January 2016.

Includes material on:

- use of small vehicles (such as vans, minibuses, taxis, rickshaws and similar) to transport people with disabilities door-to-door or along special routes
- types of vehicles and new technologies
- eligibility screening
- wheelchair safety
- scheduling, dispatching and operations, and
- promotion and outreach.

Axelsson, C. (undated). *Disability inclusive disaster risk management: Voices from the field and good practices*. http://www.cbm.org/article/downloads/54741/Disability_Inclusive_Disaster_Risk_Management.pdf. Access Date: 29 January 2016.

Includes material on:

- involving people with disabilities in emergency and preparedness planning
- meaningful community participation
- inclusive early warning systems
- shifting from relief to resilience.

Cairns Airport Pty. Ltd. (2013). *Disability access facilitation plan for Cairns Airport*. http://www.cairnsairport.com.au/wp-content/uploads/2014/04/Cairns_Airport_Disability_Access_Facilitation_Plan.pdf, Australia: Cairns Airport Pty. Ltd. Access Date: 20 January 2016.

Provides information on a range of features including:

- at the kerbside and car park
- security screening
- counter heights
- self check-in booths
- toilet facilities
- access to and from aircraft
- guide dogs and other assistance animals
- responsibilities, and
- communication strategies.

Economic and Social Commission for Asian and the Pacific. (2003). *Barrier-free tourism for people with disabilities in the Asian and Pacific region*. http://www.addc.org.au/documents/resources/barrier-free-tourism-for-people-with-disabilities-in-the-asian-and-pacific-region_1062.pdf, New York: United Nations. Access Date: 29 January 2016.



Includes material on:

- concepts about barriers
- underlying social and cultural constraints
- transport barriers
- accessible accommodation, and
- mobility maps.

Elde, A.H., & Loeb, M.E. (2005). *Data and statistics on disability in developing countries*. http://r4d.dfid.gov.uk/pdf/outputs/disability/thematic_stats.pdf, England: Department for International Development (UK).

Includes:

- literature review on data about disability in low-income countries
- review of three international initiatives to improve disability statistics, and
- results from a workshop in Africa about disability research, the role of disabled persons organisations and governments, and capacity building for good data collection.

Stubbs, D., & Tawake, S. (2009). *Pacific sisters with disabilities: At the intersection of discrimination*. <http://wwda.org.au/wp-content/uploads/2013/12/pacificsisters1.pdf>, Fiji: United Nations Development Program. Access Date: 20 January 2016.

Includes material on:

- challenges for women and girls with disabilities
- laws and policies in Pacific Island governments
- disabled people's organisations
- women's organisations
- the role of the private sector, and
- the role of development partners

Takamine, Y. (2004). *Infrastructure services and social inclusion of persons with disabilities and older persons in East Asia and the Pacific*. <http://siteresources.worldbank.org/INTEAPINFRASTRUCT/Resouces/855084-1137106254308/AccessDisabled.pdf>, Japan: University of the Ryukyus. Access Date: 29 January 2016.

Includes material on:

- disability and poverty
- defining transport-disadvantaged groups
- creation of local level access advocacy or working groups
- funding for transport systems with access features
- incremental implementation of strategies to improve access in transport systems
- rural considerations, and
- practical guidelines on enhancing access and mobility of people with disabilities.

Tavola, H. (2012). *Addressing inequalities: Disability in Pacific island countries*. http://www.adds.org.au/documents/resources/addressing-inequality-disability-in-the-pacific-island-countries_931.pdf, Fiji: United Nations Economic and Social Commission for Asia and the Pacific. Access Date: 20 January 2016.



Includes material on:

- particular issues for people with disabilities living in the Pacific region
- situation of women and children with disabilities
- education and training for people with disabilities
- employment situation
- poverty and disability, and
- impact of the Pacific Regional Strategy on Disability.

Thomas, P., & Legge, M. (Eds.). (2009). Disability, disadvantage and development in the Pacific and Asia. *Development Bulletin*, 73 (April). <https://crawford.anu.edu.au/rmap/devnet/devnet/db-73.pdf>, Australia: Australian National University. Access Date: 29 January 2016.

Includes articles on:

- the Convention on the Rights of Persons with Disabilities
- vulnerability in disasters
- Australian and New Zealand development assistance for disability
- inclusive education in Timor-Leste
- community-based rehabilitation and evaluation, and
- perceptions of disability.

Thomas, P. (Ed.). (2011). Implementing disability-inclusive development in the Pacific and Asia. *Development Bulletin*, 74 (June). <http://www.vision2020australia.org.au/uploads/page/83/db-74.pdf>, Australia: Australian National University. Access Date: 29 January 2016.

Includes articles on:

- implementing disability-inclusive development in the Pacific and Asia
- key issues in the Pacific Regional Strategy
- conventions, strategies and plans in the Pacific and Asia
- lessons learned in developing and implementing national disability strategies in PNG and Timor-Leste
- the role of disabled person's organisations in development
- partnerships in providing services for people with disabilities in disaster and emergency situations
- the role of culture and ethnicity in disability inclusiveness, and
- statistics on women with disabilities.

Wiman, R., & Sandhu, J. (undated). *Integrating appropriate measures for people with disabilities in the infrastructure sector*. <http://unipd-centrodirittiumani.it/public/docs/en-disability-infrastructure-2004.pdf>, Germany: GTZ. Access Date: 20 January 2016.

Includes material on:

- inclusive planning and design
- international norms and standards
- good practice examples in policy design
- tools for inclusive development planning
- infrastructure and disability (for energy, transport, and water and sanitation), and
- disability financing.

